



Power. Precision. Performance.

M E T A L M O R P H O S I S

2022

POW•R•PATH
enDURO
STREAKERS
POW•R•FEED
OMEGA-6
INCONEX
truCORE





THE NEW FRONTIER OF ADVANCED END MILLS.

The tools in this catalog are made for a new age in metalworking, unique designs that run smarter, smoother and with incredible precision. Every innovation in each end mill series is the result of IMCO's advanced technology and our continuous drive for greater productivity. And the changes keep coming.

We're pushing boundaries and exploring technology to its outer edges. This is the new frontier, and the new age in metalworking — a metalmorphosis — is just ahead.

What's new?

INTRODUCING M213

Designed to handle extreme tool paths in aluminum alloys – the NEW STREAKERS M213 end mills provide superior surface finishes and are engineered to meet the demands of today's aerospace industry.



UPDATE TO THE M924 LINE

With the POW•R•FEED M924C we've added the benefits of our unique Chip Management System(CMS) to the versatility of the M924 design. The CMS feature breaks up long, stringy chips, which eliminates recutting chips and chip packing, and allows for free cutting tool movement.



INTRODUCING TOOLBOT

Online, dynamic application results you can trust, available to you 24/7. 365. Input your part number, material, operation, and machine limits to calculate your unique – accurate - speed and feed results.



Pictorial Index

POW•R•PATH®

POW•R•PATH Series Information **14**



IPT7 POW•R•PATH • 7-Flute • AlCrNX • Square End and Corner Radius for HEM in a Wide Range of Materials **16**



IPC7 POW•R•PATH • 7-Flute • CMS • AlCrNX • Corner Radius for HEM in a Wide Range of Materials **18**

IP7 Speed and Feed Chart **20**



IPT9 POW•R•PATH • 9-Flute • AlCrNX • Corner Radius for HEM in a Wide Range of Materials **22**



IPC9 POW•R•PATH • 9-Flute • CMS • AlCrNX • Corner Radius for HEM in a Wide Range of Materials **24**

IP9 Speed and Feed Chart **26**



IPT11 POW•R•PATH • 11-Flute • AlCrNX • Corner Radius for HEM in a Wide Range of Materials **28**



IPC11 POW•R•PATH • 11-Flute • CMS • AlCrNX • Corner Radius for HEM in a Wide Range of Materials **29**

IP11 Speed and Feed Chart **30**



IPT13 POW•R•PATH • 13-Flute • AlCrNX • Corner Radius for HEM in a Wide Range of Materials **32**



IPC13 POW•R•PATH • 13-Flute • CMS • AlCrNX • Corner Radius for HEM in a Wide Range of Materials **33**

IP13 Speed and Feed Chart **34**



APT5 POW•R•PATH • 5-Flute • taC • Square End and Corner Radius for HEM in Aluminum **36**



APT5N POW•R•PATH • 5-Flute • taC • Square End and Corner Radius w/Neck Relief for HEM in Aluminum **38**



APC5 POW•R•PATH • 5-Flute • CMS • taC • Square End and Corner Radius for HEM in Aluminum **39**

AP5 Speed and Feed Chart **40**



AFC5 POW•R•PATH • Corner Radius for Deep Wall Finishing in Aluminum **42**

AFC5 Speed and Feed Chart **43**



IFC5 POW•R•PATH • Corner Radius for Deep Wall Finishing in a Wide Range of Materials **42**

IFC5 Speed and Feed Chart **43**

enDURO®

enDURO Series Information **44**



M525 enDURO • 5-Flute • AlCrNX • Square End, Corner Radius and Ball End for Machining in Titanium and Stainless Steels **46**



M525C enDURO • 5-Flute • CMS • AlCrNX • Square End and Corner Radius for Machining in Titanium and Stainless Steels **48**



M525N enDURO • 5-Flute • AlCrNX • Square End, Corner Radius and Ball End w/Neck Relief for Machining in Titanium and Stainless Steels **49**

M525 Speed and Feed Chart **50**



M527 enDURO • 7-Flute • AlCrNX • Square End and Corner Radius for Machining in Titanium and Stainless Steels **52**



M527N enDURO • 7-Flute • AlCrNX • Corner Radius w/Neck Relief for Machining in Titanium and Stainless Steels **52**



M527C enDURO • 7-Flute • CMS • AlCrNX • Square End and Corner Radius for Machining in Titanium and Stainless Steels **53**

M527 Speed and Feed Chart **54**



M503 enDURO • 3-Flute • AlTiN • Square End and Corner Radius for Machining in Carbon and Stainless Steels **56**

M503 Speed and Feed Chart **56**

OMEGA-6™

OMEGA-6 Series Information **58**



M725/M726 OMEGA-6 • 5/6-Flute • AlTiNX • Square End and Corner Radius for Machining in Hardened Materials **60**



M725N/M726N OMEGA-6 • 5/6-Flute • AlTiNX • Corner Radius w/Neck Relief for Machining in Hardened Materials **62**

M725/M726 Speed and Feed Chart **66**



M706 OMEGA-6 • 6-Flute • AlTiN • Square End and Corner Radius for Machining in Hardened Materials **64**



M706N OMEGA-6 • 6-Flute • AlTiN • Square End and Corner Radius w/Neck Relief for Machining in Hardened Materials **65**

M706 Speed and Feed Chart **67**

INCONEX®

INCONEX Series Information **68**



M806 INCONEX • 6-Flute • AlCrNX • Corner Radius for Machining in Hi-Temp Alloys **70**



M806N INCONEX • 6-Flute • AlCrNX • Corner Radius w/Neck Relief for Machining in Hi-Temp Alloys **72**

M8 Speed and Feed Chart **73**

POW•R•FEED®

POW•R•FEED Series Information 74



M924 POW•R•FEED • 4-Flute • AlCrNX • Square End, Corner Radius and Ball End for Machining in a Wide Range of Materials 76



M924N POW•R•FEED • 4-Flute • AlCrNX • Corner Radius and Ball End w/Neck Relief for Machining in a Wide Range of Materials 78



M924C POW•R•FEED • 4-Flute • CMS • AlCrNX • Square End and Corner Radius for Machining in a Wide Range of Materials 80

M924 Speed and Feed Chart 82



M904 POW•R•FEED • 4-Flute • AlTiN • Square End, Corner Radius and Ball End for Machining in a Wide Range of Materials 84

M904 Speed and Feed Chart 85



M905 POW•R•FEED • 5-Flute • AlTiN • Square End and Corner Radius for Machining in a Wide Range of Materials 86

M905 Speed and Feed Chart 86

STREAKERS®

STREAKERS Series Information 88



M213 STREAKERS • 3-Flute • Square End, Corner Radius and Ball End for High Performance Machining in Aluminum 90



M213C STREAKERS • 3-Flute • CMS • Corner Radius for High Performance Machining in Aluminum 92

M213 Speed and Feed Chart 93



M213N STREAKERS • 3-Flute • Square End, Corner Radius and Ball End w/Neck Relief for Machining in Aluminum 94

M213N Speed and Feed Chart 95



M223 STREAKERS • 3-Flute • ZrN • Square End, Corner Radius and Ball End for Machining in Aluminum 96



M223N STREAKERS • 3-Flute • ZrN • Square End, Corner Radius and Ball End w/Neck Relief for Machining in Aluminum 98

M223 Speed and Feed Chart 100



M233 STREAKERS • 3-Flute • ZrN • Corner Radius for Machining in Aluminum 102

M233 Speed and Feed Chart 104



M203 STREAKERS • 3-Flute • Uncoated • Square End and Corner Radius for Machining in Aluminum 106



M203N STREAKERS • 3-Flute • Uncoated • Square End w/Neck Relief for Machining in Aluminum 107



M202 STREAKERS • 2-Flute • Uncoated • Square End, Corner Radius and Ball End for Machining in Aluminum 108



M202N STREAKERS • 2-Flute • Uncoated • Square End w/Neck Relief for Machining in Aluminum 109

M203/M202 Speed and Feed Chart 110

truCORE®

truCORE Series Information 112



E14 truCORE • 4-Flute • AlTiN • Square End, Corner Radius and Ball End for General Machining 114



E14 truCORE • 4-Flute • TiCN • Square End and Ball End For General Machining 117



E14 truCORE • 4-Flute • Uncoated • Square End and Ball End for General Machining 118



E14 truCORE • 4-Flute • TiN • Square End for General Machining 120



E24 truCORE • 4-Flute • AlTiN • Square End and Ball End for General Machining 121



E13 truCORE • 3-Flute • AlTiN • Square End and Ball End for General Machining 122



E13 truCORE • 3-Flute • Uncoated • Square End for General Machining 124



E12 truCORE • 2-Flute • AlTiN • Square End and Ball End for General Machining 126



E12 truCORE • 2-Flute • Uncoated • Square End and Ball End for General Machining 128

E Series Speed and Feed Chart 130



M104 truCORE • 4-Flute • AlTiN • Square End for General Machining 132

M104 Speed and Feed Chart 132



E520B truCORE • 2-Flute • AlTiN • Ball End w/Neck Relief for Hardened Metals 133

E520B Speed and Feed Chart 133

Technical Resources 134

IMCO's High-Performance End Mill Families

Driven to meet your cutting tool needs.

The world of metalworking is constantly bombarded with tougher demands, from working in difficult-to-machine materials to making parts faster. Even new advancements, like those in CAM software packages, create challenges for today's users of cutting tools.

The team at IMCO helps our customers meet those demands and turn them into opportunities. Our innovative designs create families of tools made to maximize performance in a wide range of materials by utilizing high-quality substrates, coatings and grinds. In-house development and testing with both traditional and high-efficiency CAM tool paths ensure that all IMCO tools excel in a wide variety of applications.



POW•R•PATH® IP

- Designed specifically for high-efficiency machining in ferrous materials and hi-temp alloys.
- The "go-to" tool when using today's advanced machining techniques.
- 7, 9, 11, & 13 flute options for maximize productivity and tool life.



POW•R•PATH® AP

- For high-efficiency machining in aluminum alloys.
- Innovative 5-flute design and coating maximizes output without chip packing, yielding high output and long tool life.



DEEP WALL FINISHER AFC5/IFC5

- Unique cutting edge geometry and thick core, minimizing wall taper in deep cuts.



enDURO® M5

- Most versatile tool on the market – machines in both traditional and HEM tool paths.
- 5- and 7-flute designs for roughing and finishing in a wide range of materials.



OMEGA-6™ M7

- Advanced geometry and coating for hard milling applications.
- High-helix 5- and 6-flute end mills, great for machining materials > 48 HRC and for finish milling in a wide range of materials.



INCONEX® M8

- Unique design for long tool life when machining hi-temp alloys.
- 6 flutes for longer tool life in traditional cuts in difficult-to-machine materials.



POW•R•FEED® M9

- Brings high performance to 4- and 5-flute end mills with a vibration-dampening design for slotting, pocketing and roughing in many materials in traditional cuts.

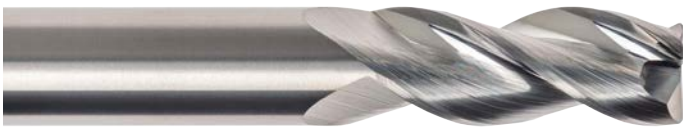

STREAKERS® M2

- Advanced 2- and 3-flute designs for machining aluminum.
- New 3-flute design for high performance machining in aluminum.



truCORE® E SERIES

- Traditional 2-, 3- and 4-flute end mills for reliable and consistent performance in general machining.

imcousa.com

Point. Click. Game changed.

User-focused navigation – Start with machining type then you choose how you want to look further – by tool family, by application or by end type, whatever works best for you.

Complete tool info – Dimensions and drawings, flutes, coatings, end cuts, sizes ... everything you need to know. Downloadable catalogs, too.

Real-time data for distributors – Password-protected access 24/7 for secure online ordering, real-time inventory checks, pricing and more. With 24/7 access to real-time information, you can respond to customer needs on the spot, anytime. When priorities shift from minute to minute, **speed and flexibility** are game changers.

“Our information technology should be as advanced, intuitive and productivity-driven as our cutting tool technology. Now, it is.”

– IMCO President Perry Osburn



 Like us on Facebook
@IMCO Carbide Tool

 Follow us on Instagram
@imcousa

Tool Selection Guide Introduction

Choose the right tool for your job.

Deciding which end mill to use in an application now goes beyond matching the end mill to the material. The programming style – high-efficiency machining or traditional – plays a key role in determining which tool will decrease cycle time and maximize tool life.

Our tool selection charts on pages 10–13 can help you pick the best tool for the material and the programming you use. Detailed speed, feed and tool engagement information can be found at the end of each product section.

HEM vs. Traditional: Which is best?



HEM Tool Path

High-efficiency machining (HEM) can greatly reduce the cycle time of a job AND improve tool life. HEM uses advanced tool paths that maintain consistent pressure on cutting tools and the machine spindle. Common characteristics of these tool paths are:

- Light radial cuts (step-overs)
- Deep axial cuts
- Elliptical tool paths when slotting and pocketing

Traditional tool paths use straight-line moves that generate heavy tool engagement, intense pressure in the corners, and the potential for the tool to break. That means the machine “looks ahead” and slows down the tool or requires programming speeds and feeds that allow the end mill to survive sharp turns.

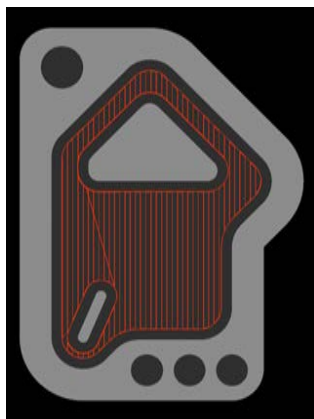

Traditional Tool Path

With HEM, the potential for reduced costs through faster cycle times and increased tool life is *huge*.

See example in sidebar at right:

MACHINING 316 STAINLESS STEEL

Must remove .150" from a wall 1.5" tall.

Traditional method

using IMCO M924 Series ½" OD 4-flute end mill, taking a radial DOC of 30% of the diameter and an axial DOC of 1.25 x D (.625" in this example).

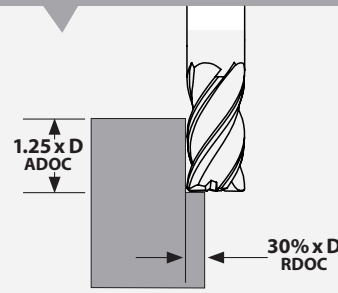

HEM method

roughing out the same part using the IPT 7-flute end mill, taking a radial DOC of 8% of the diameter and an axial DOC of 3 x D (the full 1.5" of the wall in this example).

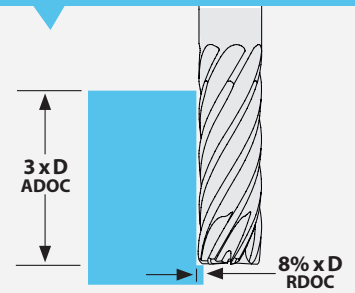

SPEED

325 SFM

2483 RPM

440 SFM

3361 RPM

CHIP LOAD

.0033 in. per tooth

.0058 in. per tooth

FEED RATE

32.77 in. per minute

2483 RPM x
[.0033 IPT x
4-flutes]

136 in. per minute

3361 RPM x
[.0058 IPT x
7-flutes]

METAL REMOVAL RATE

3.072 in³

32.77 IPM x
.150" radial
cut per pass x
.625" axial cut
per pass

8.16 in³

136 IPM x
.040" radial
cut per pass x
1.5" axial cut
per pass

In this example, material is removed 2.5 x faster using the HEM IPT end mill versus a traditional path. The metal removal rate is measured in cubic inches: at IMCO, “It’s all about the cubes.”

Do all end mills run well in HEM tool paths?

All end mills are **not** created equal when it comes to HEM. End mills with multiple flutes, thick cores and strong corner radii are much more effective than traditional 4-flute tools. IMCO has created end mills specifically for HEM tool paths and others that can run both HEM and traditional cuts. It's all indicated in our tool selection guide.

Is HEM the best method to run on every job?

No. In general, **HEM does show significant savings** in most applications, but it really shines when you can run an axial depth of cut that is 1.25 x the tool diameter or greater. Traditional tool paths run well on very short runs and simple, shallow cuts.

An easy way to check if HEM will run a job faster is to calculate the metal removal rate, or MRR. The MRR takes the tool feed rate and multiplies that by the tool engagement to determine how many cubic inches or centimeters the tool removes in one minute.

$$MRR = \text{Feed rate of the tool} \times \text{width of cut} \times \text{depth of cut}$$

OR

$$MRR = (RPM \times IPT \times \# \text{ of flutes}) \times \text{radial DOC} \times \text{axial DOC}$$

Plug in the numbers for the feed rate, step-over (RDOC) and the axial depth of cut (ADOC) the tool manufacturer recommends to compare the MRRs of both programming techniques. **On parts that require cutting at least 1.25 x the tool diameter deep, you will find that HEM shines.** Use the chart below to determine the best tool and path to use based on the axial depths (ADOC).

MRR Ranking	1.25 x D axial depths	1.5 - 2 x D axial depths	2.5 x D axial depths	3 x D axial depths
1	IP13 - HEM	IP13 - HEM	IP9 - HEM	IP9 - HEM
2	IP9 - HEM	IP9 - HEM	IP11 - HEM	IP7 - HEM
3	IP11 - HEM	IP11 - HEM	IP7 - HEM	M527 - HEM
4	M525 - Traditional	IP7 - HEM	IP13 - HEM	IP13 - HEM
5	M527 - Traditional	M527 - HEM	M527 - HEM	M525 - HEM
6	IP7 - HEM	M525 - HEM	M525 - HEM	IP11 - HEM
7	M527 - HEM	-	-	-
8	M525 - HEM	-	-	-

1=highest MRR, 8=lowest MRR

Chart assumes adequate coolant and no chip pollution in the cut. Chart is typical for most ferrous materials and hi-temp alloys.

Will the deep cuts used in HEM create chip pollution?

Yes, HEM can generate long chips based on the light step-over and deep cuts. The chips of some materials tend to break easily, and the coolant is effective in taking them out of the cutting zone. Other materials can cause issues. IMCO has developed special grinds that break the chips for easy removal without reducing tool life. Our **Chip Management System (CMS)** is available as a standard feature on many of our high-performance end mill designs. Look for the "C" in the series number to find them.

Short chips created with CMS.



Long chips made when using a normal tool.

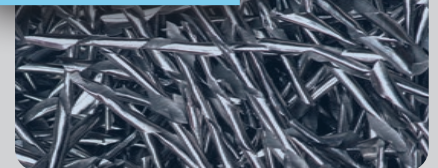

Tool Selection Guide







Pick the right tool for your material and application.

ISO Code	Work Material	Type of Cut	POW-R-PATH								
			IPT7	IPC7	IPT9	IPC9	IPT11	IPC11	IPT13	IPC13	
K	Cast Iron - Gray	Traditional Roughing									
		Traditional Finishing									
		HEM	●●●●	●●●	●●●●	●●●	●●●●	●●●	●●●●	●●●	
	Cast Iron - Malleable	Traditional Roughing									
		Traditional Finishing	●●●		●●●						
		HEM	●●●●	●●●●	●●●●	●●●●	●●●●	●●●●	●●●●	●●●●	
P	Low Carbon Steels < 48 HRC	Traditional Roughing									
		Traditional Finishing	●●●		●●●						
		HEM	●●●●	●●●●	●●●●	●●●●	●●●●	●●●●	●●●●	●●●●	
	Medium Carbon Steels < 48 HRC	Traditional Roughing									
		Traditional Finishing	●●●		●●●						
		HEM	●●●●	●●●●	●●●●	●●●●	●●●●	●●●●	●●●●	●●●●	
	Tool & Die Steels < 48 HRC	Traditional Roughing									
		Traditional Finishing	●●●		●●●						
		HEM	●●●●	●●●●	●●●●	●●●●	●●●●	●●●●	●●●●	●●●●	
H	Tool & Die Steels 48 - 62 HRC	Traditional Roughing									
		Traditional Finishing									
M	Austenitic Stainless Steels	Traditional Roughing									
		Traditional Finishing	●●●		●●●						
		HEM	●●●●	●●●●	●●●●	●●●●	●●●●	●●●●	●●●●	●●●●	
	Martensitic Stainless Steels	Traditional Roughing									
		Traditional Finishing	●●●		●●●						
		HEM	●●●●	●●●●	●●●●	●●●●	●●●●	●●●●	●●●●	●●●●	
	PH Stainless Steels	Traditional Roughing									
		Traditional Finishing	●●●		●●●						
		HEM	●●●●	●●●●	●●●●	●●●●	●●●●	●●●●	●●●●	●●●●	
S	Titanium Alloys	Traditional Roughing									
		Traditional Finishing	●●●		●●●						
		HEM	●●●●	●●●●	●●●●	●●●●	●●●●	●●●●	●●●●	●●●●	
	Hi-Temperature Alloys	Traditional Roughing									
		Traditional Finishing	●●●		●●●						
		HEM	●●●●		●●●		●●		●		
N	Aluminum Alloys	Traditional Roughing									
		Traditional Finishing									
		HEM									
	Copper Alloys, Brass, Bronze	Traditional Roughing									
		Traditional Finishing									
	Composites, Plastics, Fiberglass	Traditional Roughing									
Traditional Finishing											

POW•R•PATH				enDURO					OMEGA-6		INCONEX
APT5	APC5	AFC5	IFC5	M525	M525C	M527	M527C	M503	M725/6	M706	M806
				••••		•••					
			••••	••		•••			••••	••	
				••		••					
				••••		•••					
			••••	••		•••			••••	••	
				••		•••					
				••••	••••	•••	•••	•			
			••••	•••		•••			••••	••	
				••	••	•••	•••				
				••••	••	•••	••				
			••••	••		•••			••••	••	
				••	••	•••	•••				
				••••	••••	•••	•••				
			••••	••		•••			••••	••	
				••	••	•••	•••				
				••••	••••	•••	•••				
			••••	••		•••			••••	••	
				••	••	•••	•••				
				••••	••••	•••	•••				
			••••	••		•••			••••	••	••••
				••		••					
•••	•••										
••••		••••									
••••	••••										
								••			
		••••						•			
								•			
		••••									

Tool Selection Guide

Pick the right tool for your material and application.

ISO Code	Work Material	Type of Cut	STREAKERS					
			M213	M213C	M223	M233	M203	M202
								
K	Cast Iron - Gray	Traditional Roughing						
		Traditional Finishing						
		HEM						
	Cast Iron - Malleable	Traditional Roughing						
		Traditional Finishing						
		HEM						
P	Low Carbon Steels < 48 HRC	Traditional Roughing						
		Traditional Finishing						
		HEM						
	Medium Carbon Steels < 48 HRC	Traditional Roughing						
		Traditional Finishing						
		HEM						
	Tool & Die Steels < 48 HRC	Traditional Roughing						
		Traditional Finishing						
		HEM						
H	Tool & Die Steels 48 - 62 HRC	Traditional Roughing						
		Traditional Finishing						
M	Austenitic Stainless Steels	Traditional Roughing						
		Traditional Finishing						
		HEM						
	Martensitic Stainless Steels	Traditional Roughing						
		Traditional Finishing						
		HEM						
	PH Stainless Steels	Traditional Roughing						
		Traditional Finishing						
		HEM						
S	Titanium Alloys	Traditional Roughing						
		Traditional Finishing						
		HEM						
	Hi-Temperature Alloys	Traditional Roughing						
		Traditional Finishing						
		HEM						
N	Aluminum Alloys	Traditional Roughing	●●●●	●●●●	●●●	●●●	●●	●●
		Traditional Finishing	●●●●	●●●●	●●●		●●	●●
		HEM	●●●	●●●	●●●	●●	●●	●
	Copper Alloys, Brass, Bronze	Traditional Roughing	●●●	●●●	●●●●	●●●	●●	●●
		Traditional Finishing	●●●	●●●	●●●●		●●	●●
	Composites, Plastics, Fiberglass	Traditional Roughing	●●●●	●●●	●●●●	●●●	●●	●●
Traditional Finishing		●●●●	●●●	●●●●		●●	●●	

POW-R-FEED				truCORE					
M924	M924C	M904	M905	E12	E13	E14	E24	E520B	M104
•••		••	••		•	•	•		
•		•	••			•	•		
•••		••	••		•	•	•		
•		•	••			•	•		
•••	••	••	•	•	•	•	•		••
••	••	•	•			•	•		
•••	••	•	•			•	•		
••	••	•	•			•	•		
								••	
								••	
•••	••	•	•			•	•		
•	•	•	•			•	•		
•••	••	•	•	•		•	•		•
•	•	•	•			•	•		
••	•	•	•			•	•		
•	•	•	•			•	•		
••	•	•	•			•	•		
•	•	•	•			•	•		
				•					
					•				
				•	•				
		•		•	•	•	•		
		••		•	•	•	•		
		••			•	•	•		

POW•R•PATH®

MACHINING REBOOTED. PRODUCTIVITY RELOADED.

Push your productivity to the max with IMCO's POW•R•PATH IP/AP series end mills, designed specifically for high-efficiency machining (HEM). This dynamic combination of unique tool design features along with HEM tool paths increases your metal removal rates while decreasing wear on your tool. The proof is in the savings!



POW•R•PATH Series Features

New tools for the new age of machining.

Amplify the benefits of high-efficiency machining with POW•R•PATH IP/AP series cutting tools. Every aspect of POW•R•PATH end mills is optimized specifically for HEM methods to make sure you get every advantage this modern machining system can provide.

The POW•R•PATH line is the most complete offering of end mills dedicated to HEM tool paths in the market, ranging from 7 to 13 flutes for steels and hi-temp alloys, and a 5-flute design for aluminum — all available with or without the unique Chip Management System (CMS).



	IPT7	IPC7	IPT9 IPC9	IPT11 IPC11	IPT13 IPC13	APT5	APT5N	APC5	AFC5	IFC5
NUMBER OF FLUTES	Z7	Z7	Z9	Z11	Z13	Z5	Z5	Z5	Z5	Z5
END TYPES	SQ CR	CR	CR	CR	CR	SQ CR	SQ CR	CR	CR	CR
HELIX ANGLE	40°	40°	36°	34°	30°	35°	35°	35°	35°	35°
COATING	AlCrNX	AlCrNX	AlCrNX	AlCrNX	AlCrNX	taC	taC	taC	taC	AlCrNX
SHANK TYPES	PLAIN WELDON	PLAIN WELDON	PLAIN	PLAIN	PLAIN	PLAIN	PLAIN NECK	PLAIN	PLAIN	PLAIN
APPLICATIONS	HEM FINISH			HEM		HEM ROUGH FINISH		FINISH		FINISH
MATERIAL(S)		K P M S					N			K P M S

IPT7 POW•R•PATH



For high-efficiency machining (HEM) in materials ranging from low carbon steels to hi-temp alloys. The IPT7 is the most versatile of the POW•R•PATH end mills. Engineered specifically for HEM tool paths, the IPT7's unique design runs up to 4.5 x the tool diameter deep at elevated feed and metal removal rates.

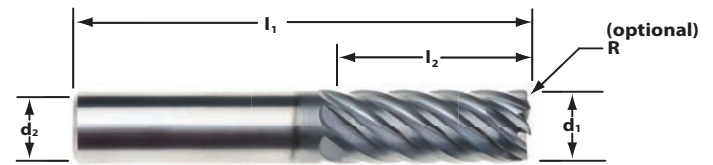

in: d1: +0.000 / -0.002 d2: -0.0001 / -0.0004
mm: d1: +0.000 / -0.050 d2: -0.0025 / -0.0100



Cutter Dia d1	Shank Dia d2	Max Axial Depth xD	Length of Cut I2	Overall Length I1	Order Code SQ	Order Code by Corner Radius						
						.015 CR	.030 CR	.060 CR	.090 CR	.125 CR	.187 CR	.250 CR
3/16	3/16	2	3/8	2	0340036	0340037	0340038	-	-	-	-	-
		3	9/16	2	0340039	0340040	0340041	-	-	-	-	-
		4	3/4	2-1/2	0340042	0340043	0340044	-	-	-	-	-
1/4	1/4	2	1/2	2	0340045	0340046	0340047	0340048	-	-	-	-
		3	3/4	2-1/2	0340049	0340050	0340051	0340052	-	-	-	-
		4	1	3	0340053	0340054	0340055	0340056	-	-	-	-
3/8	3/8	2	3/4	2-1/2	0340057	0340058	0340059	0340060	0340061	-	-	-
		2.5	15/16	2-1/2	0340062	0340063	0340064	0340065	0340066	-	-	-
		3	1-1/8	3	0340067	0340068	0340069	0340070	0340071	-	-	-
1/2	1/2	4	1-1/2	3-1/2	0340072	0340073	0340074	0340075	-	-	-	-
		2	1	3	0340076	-	0340077	0340078	0340079	0340080	-	-
		2.5	1-1/4	3-1/4	0339969	-	0339970	0339971	0339972	0339973	-	-
		3	1-1/2	3-1/2	0340086	-	0340087	0340088	0340089	0340090	-	-
		3.5	1-3/4	4	0339974	-	0339975	0339976	0339977	0339978	-	-
5/8	5/8	4	2	4	0340096	-	0340097	0340098	0340099	0340100	-	-
		4.5	2-1/4	4	0340101	-	0340102	0340103	0340104	0340105	-	-
		2	1-1/4	3-1/2	0340106	-	0340107	0340108	0340109	0340110	0340111	-
		2.5	1-9/16	4	0339979	-	0339980	0339981	0339982	0339983	0339984	-
		3	1-7/8	4	0340118	-	0340119	0340120	0340121	0340122	0340123	-
3/4	3/4	3.5	2-3/16	4-1/2	0339985	-	0339986	0339987	-	0339988	-	-
		4	2-1/2	5	0340128	-	0340129	0340130	-	0340131	-	-
		2	1-1/2	4	0340132	-	0340133	0340134	-	0340135	0340136	0340137
		2.5	1-7/8	4-1/2	0339989	-	0339990	0339991	0339992	0339993	0339994	0339995
		3	2-1/4	5	0340145	-	0340146	0340147	0340148	0340149	0340150	0340151
1	1	3.5	2-5/8	5	0340152	-	0340153	0340154	0340155	0340156	-	-
		4	3	6	0340157	-	0340158	0340159	-	0340160	-	-
		2	2	5	0339996	-	0339997	0339998	0339999	0340000	0340001	0340002
		2.5	2-1/2	5-1/2	0340003	-	0340004	0340005	0340006	0340007	0340008	0340009
		3	3	6	0340175	-	0340176	0340177	-	0340178	-	-
1	1	3.5	3-1/2	6-1/2	0340010	-	0340011	0340012	-	0340013	-	-
		4	4	7	0340183	-	0340184	0340185	-	0340186	-	-

D = Tool Diameter

Cutter Dia d1	Shank Dia d2	Max Axial Depth xD	Length of Cut l2	Overall Length l1	Order Code SQ	Order Code by Corner Radius				
						0.5 CR	1.0 CR	1.5 CR	2.0 CR	3.0 CR
6	6	2	12	57	0340230	0340231	-	-	-	-
		3	18	63	0340232	0340233	-	-	-	-
		4	24	75	0340234	0340235	-	-	-	-
8	8	2	16	58	0340556	0340557	-	-	-	-
		3	24	63	0340238	0340239	-	-	-	-
		4	32	75	0340240	0340241	-	-	-	-
10	10	2	20	66	0340242	0340243	0340244	-	-	-
		2.5	25	72	0340245	0340246	0340247	-	-	-
		3	30	75	0340248	0340249	0340250	-	-	-
		4	40	88	0340251	0340252	0340253	-	-	-
12	12	2	24	75	0340558	-	0340559	0340560	0340561	0340562
		2.5	30	83	0340259	-	0340260	0340261	0340262	0340263
		3	36	88	0340563	-	0340564	0340566	0340567	0340568
		3.5	42	93	0340569	-	0340570	0340572	0340573	0340574
		4	48	100	0340274	-	0340275	0340276	0340277	0340278
16	16	2	32	92	0340575	-	0340576	0340578	0340579	0340580
		2.5	40	100	0340581	-	0340582	0340584	0340585	0340586
		3	48	110	0340587	-	0340588	0340590	0340591	0340592
		3.5	56	110	0340294	-	0340295	0340296	0340297	0340298
		4	64	125	0340299	-	0340300	0340301	0340302	0340303
20	20	2	40	104	0340304	-	0340305	0340306	0340307	0340308
		2.5	50	115	0340593	-	0340594	0340596	0340597	0340598
		3	60	125	0340314	-	0340315	0340316	0340317	0340318
		3.5	70	135	0340599	-	0340600	0340602	0340603	0340604
		4	80	150	0340324	-	0340325	0340326	0340327	0340328
25	25	2	50	120	0340329	-	0340330	0340331	0340332	0340333
		2.5	63	135	0340014	-	0340031	0340033	0340034	0340187
		3	75	150	0340339	-	0340340	0340341	0340342	0340343
		3.5	88	165	0340188	-	0340189	0340370	0340371	0340372

D = Tool Diameter

Cutter Dia d1	Shank Dia d2	Max Axial Depth xD	Length of Cut l2	Overall Length l1	Order Code by Corner Radius		
					1.0 CR	1.5 CR	3.0 CR
12	12	3	36	88	0853437	-	0853438
		3.5	42	93	0853439	-	0853440
		4	48	100	0853441	-	0853445
16	16	3	48	110	-	0853450	0853451
		3.5	56	110	-	0853453	0853454
		4	64	125	-	0853455	0853457
20	20	3	60	125	-	0853458	0853459
		3.5	70	135	-	0853461	0853462
		4	80	150	-	0853464	0853465

IPT7_w/WELDON

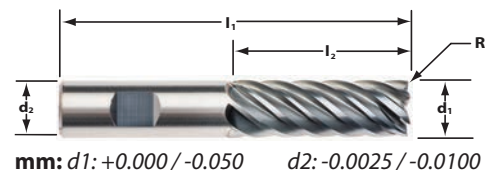

IPC7 POW•R•PATH



For high-efficiency machining (HEM) in materials ranging from low carbon steels to hi-temp alloys. Adds the benefits of the unique **Chip Management System (CMS)** to the versatility of the IPT7 design. Breaks up long, stringy chips, which eliminates recutting chips and chip packing, and allows for deep, free cutting tool movement in a variety of materials.

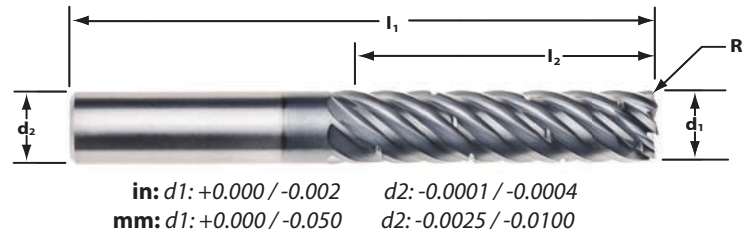

Cutter Dia d1	Shank Dia d2	Max Axial Depth xD	Length of Cut L2	Overall Length L1	Order Code by Corner Radius	
					.030 CR	.060 CR
3/8	3/8	3	1-1/8	3	0340190	-
		4	1-1/2	3-1/2	0340191	-
1/2	1/2	2.5	1-1/4	3-1/4	0340015	0340016
		3	1-1/2	3-1/2	0340194	0340195
		3.5	1-3/4	4	0340017	0340018
		4	2	4	0340198	0340199
5/8	5/8	2	1-1/4	3-1/2	0340200	0340201
		2.5	1-9/16	4	0340019	0340020
		3	1-7/8	4	0340204	0340205
		3.5	2-3/16	4-1/2	0340021	0340022
3/4	3/4	4	2-1/2	5	0340208	0340209
		2	1-1/2	4	0340210	0340211
		2.5	1-7/8	4-1/2	0340023	0340024
		3	2-1/4	5	0340214	0340215
1	1	3.5	2-5/8	5	0340216	0340217
		4	3	6	0340218	0340219
		2	2	5	0340025	0340027
		2.5	2-1/2	5-1/2	0340028	0340029
1	1	3	3	6	0340224	0340225
		3.5	3-1/2	6-1/2	0340030	0340035
		4	4	7	0340228	0340229

Cutter Dia d1	Shank Dia d2	Max Axial Depth xD	Length of Cut L2	Overall Length L1	Order Code
					1.0 CR
10	10	3	30	75	0340350
		4	40	88	0340351
12	12	2.5	30	83	0340352
		3	36	88	0340565
		3.5	42	93	0340571
		4	48	100	0340355
16	16	2	32	92	0340577
		2.5	40	100	0340583
		3	48	110	0340589
		3.5	56	110	0340359
20	20	4	64	125	0340360
		2	40	104	0340361
		2.5	50	115	0340595
		3	60	125	0340363
25	25	3.5	70	135	0340601
		4	80	150	0340365
		2	50	120	0340366
		2.5	63	135	0340032
25	25	3	75	150	0340368
		3.5	88	165	0340349

D = Tool Diameter



For high-efficiency machining (HEM) in materials ranging from low carbon steels to hi-temp alloys. Adds the benefits of the unique **Chip Management System (CMS)** to the versatility of the IPT7 design. Breaks up long, stringy chips, which eliminates recutting chips and chip packing, and allows for deep, free cutting tool movement in a variety of materials.

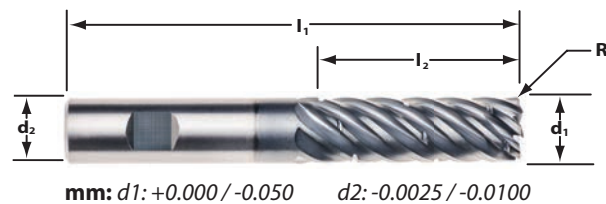

Cutter Dia d1	Shank Dia d2	Max Axial Depth xD	Length of Cut I2	Overall Length I1	Order Code 1.0 CR
12	12	3	36	88	0853466
		3.5	42	93	0853468
		4	48	100	0853469
16	16	3	48	110	0853472
		3.5	56	110	0853486
		4	64	125	0853489
20	20	3	60	125	0853490
		3.5	70	135	0853498
		4	80	150	0853500



TOOL TIP

HEM Tool Holder Recommendations.

HEM tool paths reduce the amount of radial cutting forces that are exerted on the end mill, allowing for more aggressive speeds and feeds and longer tool life. The axial cutting forces, however, are increased and work to pull the end mill out of the holder and into the part. Using a holder with a high level of gripping power is critical for successful machining in HEM tool paths. It is also important to choose a holder that minimizes the run-out of the end mill.

Holder Type	Use in HEM Programming?
Press Fit	Recommended
Shrink Fit	Recommended
Mechanical Chuck	Recommended
Hydraulic Chuck	Only if ADOC < 3xD
Advanced ER Collet	Only if ADOC < 3xD
Standard ER Collet	Not recommended
Side Lock Holder	MUST keep run-out minimized



IPT7/IPC7 Application Guide – Speed & Feed (inch)

ISO Code	Work Material	Type of Cut	Axial DOC	Radial DOC	No. of Flutes	Speed (SFM)	Feed (Inches per Tooth)						
							3/16	1/4	3/8	1/2	5/8	3/4	1
K	Gray ASTM-A48 Class 20, 25, 30, 35 & 40	Peripheral - HEM	≤ 3 x D	.1 x D	7	400	.0027	.0036	.0054	.0072	.0090	.0108	.0144
		Peripheral - HEM	> 3 x D - 4 x D	.08 x D	7	400	.0024	.0032	.0049	.0065	.0081	.0097	.0130
		Peripheral - HEM	> 4 x D - 5 x D	.08 x D	7	390	.0022	.0029	.0043	.0058	.0072	.0086	.0115
		Finish	3 x D	.015 x D	7	450	.0010	.0013	.0020	.0026	.0033	.0039	.0052
	Cast Iron Malleable	Peripheral - HEM	≤ 3 x D	.08 x D	7	390	.0022	.0029	.0044	.0058	.0073	.0087	.0116
		Peripheral - HEM	> 3 - 4 x D	.08 x D	7	390	.0020	.0026	.0039	.0052	.0065	.0078	.0104
		Peripheral - HEM	> 4 - 5 x D	.08 x D	7	375	.0017	.0023	.0035	.0046	.0058	.0070	.0093
		Finish	3 x D	.015 x D	7	350	.0008	.0011	.0016	.0021	.0026	.0032	.0042
P	Low Carbon Steels ≤ 38 Rc 1018, 1020, 12L14, 5120, 8620	Peripheral - HEM	≤ 3 x D	.08 x D	7	485	.0028	.0038	.0056	.0075	.0094	.0113	.0150
		Peripheral - HEM	> 3 - 4 x D	.08 x D	7	485	.0025	.0034	.0051	.0068	.0084	.0101	.0135
		Peripheral - HEM	> 4 - 5 x D	.08 x D	7	465	.0023	.0030	.0045	.0060	.0075	.0090	.0120
		Finish	3 x D	.015 x D	7	420	.0011	.0014	.0021	.0028	.0035	.0042	.0056
	Medium Carbon Steels ≤ 48 HRC 1045, 4140, 4340, 5140	Peripheral - HEM	≤ 3 x D	.08 x D	7	450	.0027	.0036	.0053	.0071	.0089	.0107	.0142
		Peripheral - HEM	> 3 - 4 x D	.08 x D	7	450	.0024	.0032	.0048	.0064	.0080	.0096	.0128
		Peripheral - HEM	> 4 - 5 x D	.08 x D	7	425	.0021	.0028	.0043	.0057	.0071	.0085	.0114
		Finish	3 x D	.015 x D	7	390	.0009	.0013	.0019	.0025	.0031	.0038	.0050
	Tool and Die Steels ≤ 48 Rc A2, D2, O1, S7, P20, H13	Peripheral - HEM	≤ 3 x D	.08 x D	7	420	.0024	.0032	.0048	.0064	.0080	.0096	.0128
		Peripheral - HEM	> 3 - 4 x D	.08 x D	7	420	.0022	.0029	.0043	.0058	.0072	.0086	.0115
		Peripheral - HEM	> 4 - 5 x D	.08 x D	7	395	.0019	.0026	.0038	.0051	.0064	.0077	.0102
		Finish	3 x D	.015 x D	7	365	.0008	.0011	.0016	.0021	.0026	.0032	.0042
M	Martensitic & Ferritic Stainless Steels 410, 416, 440	Peripheral - HEM	≤ 3 x D	.08 x D	7	450	.0028	.0038	.0056	.0075	.0094	.0113	.0150
		Peripheral - HEM	> 3 - 4 x D	.08 x D	7	450	.0025	.0034	.0051	.0068	.0084	.0101	.0135
		Peripheral - HEM	> 4 - 5 x D	.08 x D	7	425	.0023	.0030	.0045	.0060	.0075	.0090	.0120
		Finish	3 x D	.015 x D	7	390	.0009	.0013	.0019	.0025	.0031	.0038	.0050
	Austenitic Stainless Steels, FeNi Alloys 303, 304, 316, Invar, Kovar	Peripheral - HEM	≤ 3 x D	.08 x D	7	450	.0024	.0032	.0048	.0064	.0080	.0096	.0128
		Peripheral - HEM	> 3 - 4 x D	.08 x D	7	440	.0022	.0029	.0043	.0058	.0072	.0086	.0115
		Peripheral - HEM	> 4 - 5 x D	.07 x D	7	425	.0019	.0026	.0038	.0051	.0064	.0077	.0102
		Finish	3 x D	.015 x D	7	390	.0009	.0012	.0018	.0024	.0030	.0036	.0048
	Precipitation Hardening Stainless Steels 17-4, 15-5	Peripheral - HEM	≤ 3 x D	.08 x D	7	440	.0023	.0031	.0047	.0062	.0078	.0093	.0124
		Peripheral - HEM	> 3 - 4 x D	.08 x D	7	440	.0021	.0028	.0042	.0056	.0070	.0084	.0112
		Peripheral - HEM	> 4 - 5 x D	.07 x D	7	415	.0019	.0025	.0037	.0050	.0062	.0074	.0099
		Finish	3 x D	.015 x D	7	380	.0008	.0010	.0015	.0020	.0025	.0030	.0040
S	Titanium Alloys 6Al-4V, 6-2-4	Peripheral - HEM	≤ 3 x D	.1 x D	7	405	.0015	.0021	.0031	.0041	.0051	.0062	.0082
		Peripheral - HEM	> 3 - 4 x D	.08 x D	7	405	.0014	.0018	.0028	.0037	.0046	.0055	.0074
		Peripheral - HEM	> 4 - 5 x D	.08 x D	7	390	.0012	.0016	.0025	.0033	.0041	.0049	.0066
		Finish	3 x D	.015 x D	7	350	.0006	.0008	.0012	.0016	.0020	.0024	.0032
	Difficult-to-Machine Titanium Alloys 10-2-3	Peripheral - HEM	≤ 2.5 x D	.08 x D	7	335	.0015	.0020	.0030	.0040	.0050	.0060	.0080
		Peripheral - HEM	> 2.5 - 3.5 x D	.07 x D	7	325	.0014	.0018	.0027	.0036	.0045	.0054	.0072
	Precipitation Hardening Stainless Steel M 13-8	Peripheral - HEM	> 3.5 - 4 x D	.06 x D	7	305	.0012	.0016	.0024	.0032	.0040	.0048	.0064
		Finish	3 x D	.01 x D	7	290	.0005	.0007	.0011	.0014	.0018	.0021	.0028
	Hastalloy, Waspalloy	Peripheral - HEM	≤ 1.5 x D	.08 x D	7	100	.0035	.0047	.0071	.0094	.0118	.0141	.0188
		Peripheral - HEM	> 1.5 - 2.5 x D	.08 x D	7	95	.0032	.0042	.0063	.0085	.0106	.0127	.0169
		Peripheral - HEM	> 2.5 - 3.5 x D	.06 x D	7	85	.0028	.0038	.0056	.0075	.0094	.0113	.0150
		Finish	2 x D	.01 x D	7	90	.0019	.0025	.0038	.0050	.0063	.0075	.0100
Inconel 718, Rene 88	Peripheral - HEM	≤ 1.5 x D	.07 x D	7	95	.0035	.0047	.0070	.0093	.0116	.0140	.0186	
	Peripheral - HEM	> 1.5 - 2.5 x D	.06 x D	7	90	.0031	.0042	.0063	.0084	.0105	.0126	.0167	
	Peripheral - HEM	> 2.5 - 3 x D	.06 x D	7	85	.0028	.0037	.0056	.0074	.0093	.0112	.0149	
	Finish	2 x D	.01 x D	7	85	.0018	.0024	.0036	.0048	.0060	.0072	.0096	

D = Tool Diameter HEM = High-efficiency machining (chip thinning calculations have already been applied to HEM parameters)

≈ Approximately Equals < Less Than
 ≤ Less Than or Equal To > Greater Than
 ≥ Greater Than or Equal To = Equals
 × Multiply

Common Machining Formulas

$$RPM = \frac{SFM \times 3.82}{D}$$

$$SFM = RPM \times D \times .262$$

$$IPM = RPM \times IPT \times Z$$

$$MRR = RDOC \times ADOC \times IPM$$

$$RPM = \frac{M/min \times 318.3}{D}$$

$$M/min = RPM \times D \times .00314$$

$$MMPM = RPM \times MMPT \times Z$$

$$MRR = RDOC \times ADOC \times MMPM$$

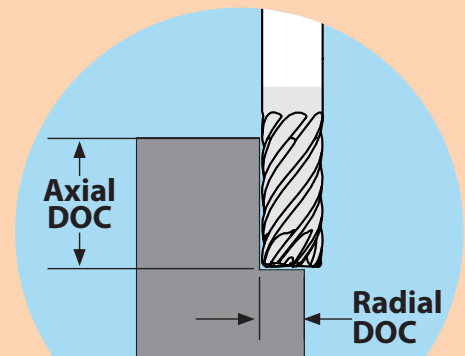

IPT7/IPC7 Application Guide – Speed & Feed (metric)

ISO Code	Work Material	Type of Cut	Axial DOC	Radial DOC	No. of Flutes	Speed (M/min)	Feed (MM per Tooth)						
							6.0	8.0	10.0	12.0	16.0	20.0	25.0
K	Gray ASTM-A48 Class 20, 25, 30, 35 & 40	Peripheral - HEM	≤ 3 x D	.1 x D	7	122	.0864	.1152	.1434	.1728	.2298	.2868	.3456
		Peripheral - HEM	> 3 - 4 x D	.08 x D	7	122	.0778	.1037	.1291	.1555	.2068	.2581	.3110
		Peripheral - HEM	> 4 - 5 x D	.08 x D	7	119	.0691	.0922	.1147	.1382	.1838	.2295	.2765
		Finish	3 x D	.015 x D	7	137	.0312	.0416	.0518	.0624	.0830	.1036	.1248
	Cast Iron Malleable	Peripheral - HEM	≤ 3 x D	.08 x D	7	119	.0696	.0928	.1155	.1392	.1851	.2311	.2784
		Peripheral - HEM	> 3 - 4 x D	.08 x D	7	119	.0626	.0835	.1040	.1253	.1666	.2079	.2505
		Peripheral - HEM	> 4 - 5 x D	.08 x D	7	114	.0557	.0742	.0924	.1114	.1481	.1848	.2227
		Finish	3 x D	.015 x D	7	107	.0252	.0336	.0418	.0504	.0670	.0837	.1008
P	Low Carbon Steels ≤ 38 Rc 1018, 1020, 12L14, 5120, 8620	Peripheral - HEM	≤ 3 x D	.08 x D	7	148	.0900	.1200	.1494	.1800	.2394	.2988	.3600
		Peripheral - HEM	> 3 - 4 x D	.08 x D	7	148	.0810	.1080	.1344	.1620	.2154	.2689	.3240
		Peripheral - HEM	> 4 - 5 x D	.08 x D	7	142	.0720	.0960	.1195	.1440	.1915	.2390	.2880
		Finish	3 x D	.015 x D	7	128	.0336	.0448	.0558	.0672	.0894	.1115	.1344
	Medium Carbon Steels ≤ 48 HRC 1045, 4140, 4340, 5140	Peripheral - HEM	≤ 3 x D	.08 x D	7	137	.0852	.1136	.1414	.1704	.2266	.2828	.3408
		Peripheral - HEM	> 3 - 4 x D	.08 x D	7	137	.0767	.1022	.1273	.1533	.2040	.2546	.3067
		Peripheral - HEM	> 4 - 5 x D	.08 x D	7	130	.0682	.0909	.1131	.1363	.1813	.2263	.2726
		Finish	3 x D	.015 x D	7	119	.0300	.0400	.0498	.0600	.0798	.0996	.1200
	Tool and Die Steels ≤ 48 Rc A2, D2, O1, S7, P20, H13	Peripheral - HEM	≤ 3 x D	.08 x D	7	128	.0768	.1024	.1275	.1536	.2043	.2550	.3072
		Peripheral - HEM	> 3 - 4 x D	.08 x D	7	128	.0691	.0922	.1147	.1382	.1838	.2295	.2765
		Peripheral - HEM	> 4 - 5 x D	.08 x D	7	120	.0614	.0819	.1020	.1229	.1634	.2040	.2457
		Finish	3 x D	.015 x D	7	111	.0252	.0336	.0418	.0504	.0670	.0837	.1008
M	Martensitic & Ferritic Stainless Steels 410, 416, 440	Peripheral - HEM	≤ 3 x D	.08 x D	7	137	.0900	.1200	.1494	.1800	.2394	.2988	.3600
		Peripheral - HEM	> 3 - 4 x D	.08 x D	7	137	.0810	.1080	.1344	.1620	.2154	.2689	.3240
		Peripheral - HEM	> 4 - 5 x D	.08 x D	7	130	.0720	.0960	.1195	.1440	.1915	.2390	.2880
		Finish	3 x D	.015 x D	7	119	.0300	.0400	.0498	.0600	.0798	.0996	.1200
	Austenitic Stainless Steels, FeNi Alloys 303, 304, 316, Invar, Kovar	Peripheral - HEM	≤ 3 x D	.08 x D	7	137	.0768	.1024	.1275	.1536	.2043	.2550	.3072
		Peripheral - HEM	> 3 - 4 x D	.08 x D	7	134	.0691	.0922	.1147	.1382	.1838	.2295	.2765
		Peripheral - HEM	> 4 - 5 x D	.07 x D	7	130	.0614	.0819	.1020	.1229	.1634	.2040	.2457
		Finish	3 x D	.015 x D	7	119	.0288	.0384	.0478	.0576	.0766	.0956	.1152
	Precipitation Hardening Stainless Steels 17-4, 15-5	Peripheral - HEM	≤ 3 x D	.08 x D	7	134	.0744	.0992	.1235	.1488	.1979	.2470	.2976
		Peripheral - HEM	> 3 - 4 x D	.08 x D	7	134	.0670	.0893	.1111	.1339	.1781	.2223	.2678
		Peripheral - HEM	> 4 - 5 x D	.07 x D	7	126	.0595	.0794	.0988	.1190	.1583	.1976	.2381
		Finish	3 x D	.015 x D	7	116	.0240	.0320	.0398	.0480	.0638	.0797	.0960
S	Titanium Alloys 6Al-4V, 6-2-4	Peripheral - HEM	≤ 3 x D	.1 x D	7	123	.0492	.0656	.0817	.0984	.1309	.1633	.1968
		Peripheral - HEM	> 3 - 4 x D	.08 x D	7	123	.0443	.0590	.0735	.0886	.1178	.1470	.1771
		Peripheral - HEM	> 4 - 5 x D	.08 x D	7	119	.0394	.0525	.0653	.0787	.1047	.1307	.1574
		Finish	3 x D	.015 x D	7	107	.0192	.0256	.0319	.0384	.0511	.0637	.0768
	Difficult-to-Machine Titanium Alloys 10-2-3 Precipitation Hardening Stainless Steel M 13-8	Peripheral - HEM	≤ 2.5 x D	.08 x D	7	102	.0480	.0640	.0797	.0960	.1277	.1593	.1920
		Peripheral - HEM	> 2.5 - 3.5 x D	.07 x D	7	99	.0432	.0576	.0717	.0864	.1149	.1434	.1728
		Peripheral - HEM	> 3.5 - 4 x D	.06 x D	7	93	.0384	.0512	.0637	.0768	.1021	.1275	.1536
		Finish	3 x D	.01 x D	7	88	.0168	.0224	.0279	.0336	.0447	.0558	.0672
	Hastalloy, Waspalloy	Peripheral - HEM	≤ 1.5 x D	.08 x D	7	30	.1128	.1504	.1872	.2256	.3000	.3745	.4512
		Peripheral - HEM	> 1.5 - 2.5 x D	.08 x D	7	29	.1015	.1353	.1685	.2030	.2700	.3370	.4060
		Peripheral - HEM	> 2.5 - 3.5 x D	.06 x D	7	26	.0902	.1203	.1498	.1805	.2400	.2996	.3609
		Finish	2 x D	.01 x D	7	27	.0600	.0800	.0996	.1200	.1596	.1992	.2400
	Inconel 718, Rene 88	Peripheral - HEM	≤ 1.5 x D	.07 x D	7	29	.1116	.1488	.1852	.2232	.2968	.3705	.4464
		Peripheral - HEM	> 1.5 - 2.5 x D	.06 x D	7	27	.1004	.1339	.1667	.2009	.2671	.3334	.4017
		Peripheral - HEM	> 2.5 - 3 x D	.06 x D	7	26	.0893	.1190	.1482	.1785	.2375	.2964	.3571
		Finish	2 x D	.01 x D	7	26	.0576	.0768	.0956	.1152	.1532	.1912	.2304

D = Tool Diameter HEM = High-efficiency machining (chip thinning calculations have already been applied to HEM parameters shown)

- D** Tool Diameter
- Z** Number of Flutes
- RPM** Revolutions per Minute
- SFM** Surface Feet per Minute
- M/min** Surface Meters per Minute
- IPM** Inches per Minute
- MMPM** Millimeters per Minute
- IPT** Inch per Tooth
- MMPT** Millimeters per Tooth
- MRR** Metal Removal Rate
- RDOC** Radial Depth of Cut
- ADOC** Axial Depth of Cut

Technical Resources

Information on tips and adjustments for the following milling operations can be found in our Technical Resources section beginning on page 134.

- HEM slotting
- Face milling
- Helical entry ramping
- Straight line ramping
- Long tool projection adjustments
- Ball nose milling adjustments
- Other helpful tips and calculations

IPT9 POW•R•PATH



For high-efficiency machining (HEM) in materials ranging from low carbon steels to hi-temp alloys. The IPT9 POW•R•PATH end mill is engineered specifically for HEM tool paths with great core strength and 9 flutes for increased feed rates and excellent surface finishes. The unique design runs up to 3.5 x the tool diameter deep, generating high metal removal rates.

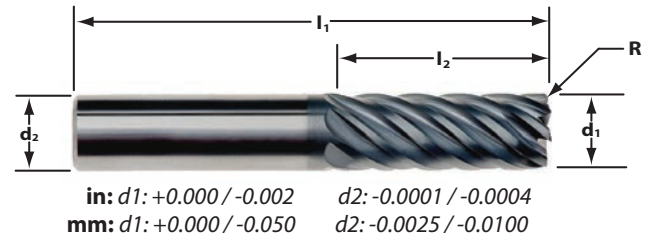

Cutter Dia d1	Shank Dia d2	Max Axial Depth xD	Length of Cut I2	Overall Length I1	Order Code by Corner Radius			
					.015 CR	.030 CR	.060 CR	.125 CR
1/4	1/4	2	1/2	2	0340488	0340489	-	-
		2.5	5/8	2-1/2	0340490	0340491	-	-
		3	3/4	2-1/2	0340492	0340493	-	-
		3.5	7/8	3	0340494	0340495	-	-
3/8	3/8	2	3/4	2-1/2	0340496	0340497	-	-
		2.5	15/16	2-1/2	0340498	0340499	-	-
		3	1-1/8	3	0340500	0340501	-	-
		3.5	1-5/16	3-1/2	0340502	0340503	-	-
1/2	1/2	2	1	3	-	0340504	0340505	-
		2.5	1-1/4	3-1/4	-	0340506	0340507	-
		3	1-1/2	3-1/2	-	0340508	0340509	-
		3.5	1-3/4	4	-	0340510	0340511	-
5/8	5/8	2	1-1/4	3-1/2	-	0340512	0340513	-
		2.5	1-9/16	4	-	0340514	0340515	-
		3	1-7/8	4	-	0340516	0340517	-
		3.5	2-3/16	4-1/2	-	0340518	0340519	-
3/4	3/4	2	1-1/2	4	-	0340520	0340521	0340522
		2.5	1-7/8	4-1/2	-	0340523	0340524	0340525
		3	2-1/4	5	-	0340526	0340527	0340528
		3.5	2-5/8	5	-	0340529	0340530	0340531
1	1	2	2	5	-	0340532	0340533	0340534
		2.5	2-1/2	5-1/2	-	0340535	0340536	0340537
		3	3	6	-	0340538	0340539	0340540
		3.5	3-1/2	6-1/2	-	0340541	0340542	0340543

D = Tool Diameter

Cutter Dia d1	Shank Dia d2	Max Axial Depth xD	Length of Cut l2	Overall Length l1	Order Code by Corner Radius			
					0.5 CR	1.0 CR	1.5 CR	3.0 CR
6	6	2	12	57	0340787	0340788	-	-
		2.5	15	57	0340789	0340790	-	-
		3	18	63	0340791	0340792	-	-
		3.5	21	75	0340793	0340794	-	-
8	8	2.5	20	63	0340795	0340796	-	-
		3	24	63	0340797	0340798	-	-
		3.5	28	75	0340799	0340800	-	-
10	10	2	20	66	0340801	0340802	-	-
		2.5	25	72	0340803	0340804	-	-
		3	30	75	0340805	0340806	-	-
		3.5	35	88	0340807	0340808	-	-
12	12	2	24	75	-	0340809	0340810	-
		2.5	30	83	-	0340811	0340812	-
		3	36	88	-	0340813	0340814	-
		3.5	42	93	-	0340815	0340816	-
16	16	2	32	92	-	0340817	0340818	-
		2.5	40	100	-	0340819	0340820	-
		3	48	110	-	0340821	0340822	-
		3.5	56	110	-	0340823	0340824	-
20	20	2	40	104	-	0340825	0340826	0340827
		2.5	50	115	-	0340828	0340829	0340830
		3	60	125	-	0340831	0340832	0340833
		3.5	70	135	-	0340834	0340835	0340836
25	25	2	50	120	-	0340837	-	0340838
		2.5	63	135	-	0340839	-	0340840
		3	75	150	-	0340841	-	0340842
		3.5	88	165	-	0340843	-	0340844

D = Tool Diameter

TOOL TIP

Determining Power Requirements.

It can be helpful to understand the power requirements for an application. The following formulas calculate spindle and motor horsepower and spindle torque.

STEP 1: Metal Removal Rate (MRR) =
(Tool Feed Rate) x Radial DOC x Axial DOC

STEP 2: Spindle HP = Metal Removal Rate x UHP

STEP 3: Motor HP = Spindle HP / Efficiency

STEP 4: Spindle Torque (ft. lbs.) =
(Spindle HP x 63,030) / RPM

UHP Factors Rating

Material	Factor
Aluminum	0.3
Cast iron	0.8
Carbon steel	1
Alloy steel	1.1
Mold steel	1.2
Tool steel	1.2
Stainless steel	1.5
Titanium	1.8
Hi-temp alloys	2

Efficiency Ratings

Spindle Type	%
Direct drive	90%
Gear drive	85%
2 Belt	70%
1 Belt	50%
Average	80%

IPC9 POW•R•PATH

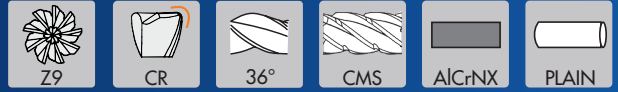

For high-efficiency machining (HEM) in materials ranging from low carbon steels to hi-temp alloys. Adds the benefits of the unique **Chip Management System (CMS)** to the versatility of the IPT9 design. Breaks up long, stringy chips, which eliminates recutting chips and chip packing, and allows for deep, free cutting tool movement in a variety of materials.

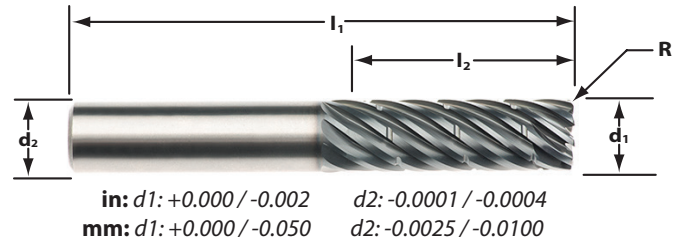

Cutter Dia d1	Shank Dia d2	Max Axial Depth xD	Length of Cut I2	Overall Length I1	Order Code by Corner Radius		
					.030 CR	.060 CR	.125 CR
1/2	1/2	2	1	3	0340389	-	-
		2.5	1-1/4	3-1/4	0340555	-	-
		3	1-1/2	3-1/2	0340393	0340475	-
		3.5	1-3/4	4	0340544	0340476	-
5/8	5/8	2	1-1/4	3-1/2	0340397	-	-
		2.5	1-9/16	4	0340545	0340477	-
		3	1-7/8	4	0340401	0340478	-
		3.5	2-3/16	4-1/2	0340546	0340479	-
3/4	3/4	2	1-1/2	4	0340405	0340480	0340406
		2.5	1-7/8	4-1/2	0340547	0340481	0340548
		3	2-1/4	5	0340409	0340482	0340410
		3.5	2-5/8	5	0340411	0340483	0340412
1	1	2	2	5	0340549	0340484	0340550
		2.5	2-1/2	5-1/2	0340551	0340485	0340552
		3	3	6	0340417	0340486	0340418
		3.5	3-1/2	6-1/2	0340553	0340487	0340554

Cutter Dia d1	Shank Dia d2	Max Axial Depth xD	Length of Cut I2	Overall Length I1	Order Code by Corner Radius		
					1.0 CR	1.5 CR	3.0 CR
12	12	2	24	75	0340605	-	-
		2.5	30	83	0340445	-	-
		3	36	88	0340606	0340845	-
		3.5	42	93	0340607	0340846	-
16	16	2	32	92	0340608	-	-
		2.5	40	100	0340609	0340847	-
		3	48	110	0340610	0340848	-
		3.5	56	110	0340457	0340849	-
20	20	2	40	104	0340459	0340850	0340460
		2.5	50	115	0340611	0340851	0340612
		3	60	125	0340463	0340852	0340464
		3.5	70	135	0340613	0340853	0340614
25	25	2	50	120	0340467	-	0340468
		2.5	63	135	0853501	-	0853502
		3	75	150	0340471	-	0340472
		3.5	88	165	0853505	-	0853507

D = Tool Diameter



IPT9/IPC9 Application Guide – Speed & Feed (inch)

ISO Code	Work Material	Type of Cut	Axial DOC	Radial DOC	No. of Flutes	Speed (SFM)	Feed (Inches per Tooth)					
							1/4	3/8	1/2	5/8	3/4	1
K	Gray ASTM-A48 Class 20, 25, 30, 35 & 40	Peripheral - HEM	≤ 3 x D	.1 x D	9	400	.0036	.0054	.0072	.0090	.0108	.0144
		Peripheral - HEM	> 3 - 4 x D	.08 x D	9	400	.0032	.0049	.0065	.0081	.0097	.0130
		Peripheral - HEM	> 4 - 5 x D	.08 x D	9	390	.0029	.0043	.0058	.0072	.0086	.0115
		Finish	3 x D	.015 x D	9	450	.0013	.0020	.0026	.0033	.0039	.0052
	Cast Iron Malleable	Peripheral - HEM	≤ 3 x D	.08 x D	9	390	.0029	.0044	.0058	.0073	.0087	.0116
		Peripheral - HEM	> 3 - 4 x D	.08 x D	9	390	.0026	.0039	.0052	.0065	.0078	.0104
		Peripheral - HEM	> 4 - 5 x D	.08 x D	9	375	.0023	.0035	.0046	.0058	.0070	.0093
		Finish	3 x D	.015 x D	9	350	.0011	.0016	.0021	.0026	.0032	.0042
P	Low Carbon Steels ≤ 38 Rc 1018, 1020, 12L14, 5120, 8620	Peripheral - HEM	≤ 3 x D	.08 x D	9	485	.0038	.0056	.0075	.0094	.0113	.0150
		Peripheral - HEM	> 3 - 4 x D	.08 x D	9	485	.0034	.0051	.0068	.0084	.0101	.0135
		Peripheral - HEM	> 4 - 5 x D	.08 x D	9	465	.0030	.0045	.0060	.0075	.0090	.0120
		Finish	3 x D	.015 x D	9	420	.0014	.0021	.0028	.0035	.0042	.0056
	Medium Carbon Steels ≤ 48 HRC 1045, 4140, 4340, 5140	Peripheral - HEM	≤ 3 x D	.08 x D	9	450	.0036	.0053	.0071	.0089	.0107	.0142
		Peripheral - HEM	> 3 - 4 x D	.08 x D	9	450	.0032	.0048	.0064	.0080	.0096	.0128
		Peripheral - HEM	> 4 - 5 x D	.08 x D	9	425	.0028	.0043	.0057	.0071	.0085	.0114
		Finish	3 x D	.015 x D	9	390	.0013	.0019	.0025	.0031	.0038	.0050
	Tool and Die Steels ≤ 48 Rc A2, D2, O1, S7, P20, H13	Peripheral - HEM	≤ 3 x D	.08 x D	9	420	.0032	.0048	.0064	.0080	.0096	.0128
		Peripheral - HEM	> 3 - 4 x D	.08 x D	9	420	.0029	.0043	.0058	.0072	.0086	.0115
		Peripheral - HEM	> 4 - 5 x D	.08 x D	9	395	.0026	.0038	.0051	.0064	.0077	.0102
		Finish	3 x D	.015 x D	9	365	.0011	.0016	.0021	.0026	.0032	.0042
M	Martensitic & Ferritic Stainless Steels 410, 416, 440	Peripheral - HEM	≤ 3 x D	.08 x D	9	450	.0038	.0056	.0075	.0094	.0113	.0150
		Peripheral - HEM	> 3 - 4 x D	.08 x D	9	450	.0034	.0051	.0068	.0084	.0101	.0135
		Peripheral - HEM	> 4 - 5 x D	.08 x D	9	425	.0030	.0045	.0060	.0075	.0090	.0120
		Finish	3 x D	.015 x D	9	390	.0013	.0019	.0025	.0031	.0038	.0050
	Austenitic Stainless Steels, FeNi Alloys 303, 304, 316, Invar, Kovar	Peripheral - HEM	≤ 3 x D	.08 x D	9	450	.0032	.0048	.0064	.0080	.0096	.0128
		Peripheral - HEM	> 3 - 4 x D	.08 x D	9	440	.0029	.0043	.0058	.0072	.0086	.0115
		Peripheral - HEM	> 4 - 5 x D	.07 x D	9	425	.0026	.0038	.0051	.0064	.0077	.0102
		Finish	3 x D	.015 x D	9	390	.0012	.0018	.0024	.0030	.0036	.0048
	Precipitation Hardening Stainless Steels 17-4, 15-5	Peripheral - HEM	≤ 3 x D	.08 x D	9	440	.0031	.0047	.0062	.0078	.0093	.0124
		Peripheral - HEM	> 3 - 4 x D	.08 x D	9	440	.0028	.0042	.0056	.0070	.0084	.0112
		Peripheral - HEM	> 4 - 5 x D	.07 x D	9	415	.0025	.0037	.0050	.0062	.0074	.0099
		Finish	3 x D	.015 x D	9	380	.0010	.0015	.0020	.0025	.0030	.0040
S	Titanium Alloys 6Al-4V, 6-2-4	Peripheral - HEM	≤ 3 x D	.1 x D	9	405	.0021	.0031	.0041	.0051	.0062	.0082
		Peripheral - HEM	> 3 - 4 x D	.08 x D	9	405	.0018	.0028	.0037	.0046	.0055	.0074
		Peripheral - HEM	> 4 - 5 x D	.08 x D	9	390	.0016	.0025	.0033	.0041	.0049	.0066
		Finish	3 x D	.015 x D	9	350	.0008	.0012	.0016	.0020	.0024	.0032
	Difficult-to-Machine Titanium Alloys 10-2-3	Peripheral - HEM	≤ 2.5 x D	.08 x D	9	335	.0020	.0030	.0040	.0050	.0060	.0080
		Peripheral - HEM	> 2.5 - 3.5 x D	.07 x D	9	325	.0018	.0027	.0036	.0045	.0054	.0072
		Peripheral - HEM	> 3.5 - 4 x D	.06 x D	9	305	.0016	.0024	.0032	.0040	.0048	.0064
		Finish	3 x D	.01 x D	9	290	.0007	.0011	.0014	.0018	.0021	.0028
	Hastalloy, Waspalloy	Peripheral - HEM	≤ 1.5 x D	.08 x D	9	100	.0045	.0068	.0090	.0113	.0135	.0180
		Peripheral - HEM	> 1.5 - 2.5 x D	.08 x D	9	95	.0041	.0061	.0081	.0101	.0122	.0162
		Peripheral - HEM	> 2.5 - 3.5 x D	.06 x D	9	85	.0036	.0054	.0072	.0090	.0108	.0144
		Finish	2 x D	.01 x D	9	90	.0024	.0036	.0048	.0060	.0072	.0096
Inconel 718, Rene 88	Peripheral - HEM	≤ 1.5 x D	.07 x D	9	95	.0046	.0068	.0091	.0114	.0137	.0182	
	Peripheral - HEM	> 1.5 - 2.5 x D	.06 x D	9	90	.0041	.0061	.0082	.0102	.0123	.0164	
	Peripheral - HEM	> 2.5 - 3 x D	.06 x D	9	85	.0036	.0055	.0073	.0091	.0109	.0146	
	Finish	2 x D	.01 x D	9	85	.0023	.0035	.0046	.0058	.0069	.0092	

D = Tool Diameter HEM = High-efficiency machining (chip thinning calculations have already been applied to HEM parameters)

≈ Approximately Equals < Less Than
 ≤ Less Than or Equal To > Greater Than
 ≥ Greater Than or Equal To = Equals
 × Multiply

Common Machining Formulas

$$RPM = \frac{SFM \times 3.82}{D}$$

$$SFM = RPM \times D \times .262$$

$$IPM = RPM \times IPT \times Z$$

$$MRR = RDOC \times ADOC \times IPM$$

$$RPM = \frac{M/min \times 318.3}{D}$$

$$M/min = RPM \times D \times .00314$$

$$MMPM = RPM \times MMPT \times Z$$

$$MRR = RDOC \times ADOC \times MMPM$$

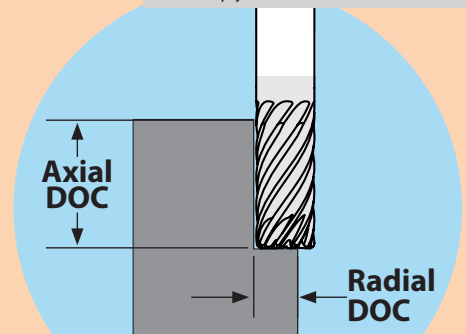

IPT9/IPC9 Application Guide – Speed & Feed (metric)

ISO Code	Work Material	Type of Cut	Axial DOC	Radial DOC	No. of Flutes	Speed (M/min)	Feed (MM per Tooth)						
							6.0	8.0	10.0	12.0	16.0	20.0	25.0
K	Gray ASTM-A48 Class 20, 25, 30, 35 & 40	Peripheral - HEM	≤ 3 x D	.1 x D	9	122	.0864	.1152	.1434	.1728	.2298	.2868	.3456
		Peripheral - HEM	> 3 - 4 x D	.08 x D	9	122	.0778	.1037	.1291	.1555	.2068	.2581	.3110
		Peripheral - HEM	> 4 - 5 x D	.08 x D	9	119	.0691	.0922	.1147	.1382	.1838	.2295	.2765
		Finish	3 x D	.015 x D	9	137	.0312	.0416	.0518	.0624	.0830	.1036	.1248
	Cast Iron Malleable	Peripheral - HEM	≤ 3 x D	.08 x D	9	119	.0696	.0928	.1155	.1392	.1851	.2311	.2784
		Peripheral - HEM	> 3 - 4 x D	.08 x D	9	119	.0626	.0835	.1040	.1253	.1666	.2079	.2505
		Peripheral - HEM	> 4 - 5 x D	.08 x D	9	114	.0557	.0742	.0924	.1114	.1481	.1848	.2227
		Finish	3 x D	.015 x D	9	107	.0252	.0336	.0418	.0504	.0670	.0837	.1008
P	Low Carbon Steels ≤ 38 Rc 1018, 1020, 12L14, 5120, 8620	Peripheral - HEM	≤ 3 x D	.08 x D	9	148	.0900	.1200	.1494	.1800	.2394	.2988	.3600
		Peripheral - HEM	> 3 - 4 x D	.08 x D	9	148	.0810	.1080	.1344	.1620	.2154	.2689	.3240
		Peripheral - HEM	> 4 - 5 x D	.08 x D	9	142	.0720	.0960	.1195	.1440	.1915	.2390	.2880
		Finish	3 x D	.015 x D	9	128	.0336	.0448	.0558	.0672	.0894	.1115	.1344
	Medium Carbon Steels ≤ 48 HRC 1045, 4140, 4340, 5140	Peripheral - HEM	≤ 3 x D	.08 x D	9	137	.0852	.1136	.1414	.1704	.2266	.2828	.3408
		Peripheral - HEM	> 3 - 4 x D	.08 x D	9	137	.0767	.1022	.1273	.1533	.2040	.2546	.3067
		Peripheral - HEM	> 4 - 5 x D	.08 x D	9	130	.0682	.0909	.1131	.1363	.1813	.2263	.2726
		Finish	3 x D	.015 x D	9	119	.0300	.0400	.0498	.0600	.0798	.0996	.1200
	Tool and Die Steels ≤ 48 Rc A2, D2, O1, S7, P20, H13	Peripheral - HEM	≤ 3 x D	.08 x D	9	128	.0768	.1024	.1275	.1536	.2043	.2550	.3072
		Peripheral - HEM	> 3 - 4 x D	.08 x D	9	128	.0691	.0922	.1147	.1382	.1838	.2295	.2765
		Peripheral - HEM	> 4 - 5 x D	.08 x D	9	120	.0614	.0819	.1020	.1229	.1634	.2040	.2457
		Finish	3 x D	.015 x D	9	111	.0252	.0336	.0418	.0504	.0670	.0837	.1008
M	Martensitic & Ferritic Stainless Steels 410, 416, 440	Peripheral - HEM	≤ 3 x D	.08 x D	9	137	.0900	.1200	.1494	.1800	.2394	.2988	.3600
		Peripheral - HEM	> 3 - 4 x D	.08 x D	9	134	.0810	.1080	.1344	.1620	.2154	.2689	.3240
		Peripheral - HEM	> 4 - 5 x D	.07 x D	9	130	.0720	.0960	.1195	.1440	.1915	.2390	.2880
		Finish	3 x D	.015 x D	9	119	.0300	.0400	.0498	.0600	.0798	.0996	.1200
	Austenitic Stainless Steels, FeNi Alloys 303, 304, 316, Invar, Kovar	Peripheral - HEM	≤ 3 x D	.08 x D	9	137	.0768	.1024	.1275	.1536	.2043	.2550	.3072
		Peripheral - HEM	> 3 - 4 x D	.08 x D	9	137	.0691	.0922	.1147	.1382	.1838	.2295	.2765
		Peripheral - HEM	> 4 - 5 x D	.08 x D	9	130	.0614	.0819	.1020	.1229	.1634	.2040	.2457
		Finish	3 x D	.015 x D	9	119	.0288	.0384	.0478	.0576	.0766	.0956	.1152
	Precipitation Hardening Stainless Steels 17-4, 15-5	Peripheral - HEM	≤ 3 x D	.08 x D	9	134	.0744	.0992	.1235	.1488	.1979	.2470	.2976
		Peripheral - HEM	> 3 - 4 x D	.08 x D	9	134	.0670	.0893	.1111	.1339	.1781	.2223	.2678
		Peripheral - HEM	> 4 - 5 x D	.07 x D	9	126	.0595	.0794	.0988	.1190	.1583	.1976	.2381
		Finish	3 x D	.015 x D	9	116	.0240	.0320	.0398	.0480	.0638	.0797	.0960
S	Titanium Alloys 6Al-4V, 6-2-4	Peripheral - HEM	≤ 3 x D	.1 x D	9	123	.0492	.0656	.0817	.0984	.1309	.1633	.1968
		Peripheral - HEM	> 3 - 4 x D	.08 x D	9	123	.0443	.0590	.0735	.0886	.1178	.1470	.1771
		Peripheral - HEM	> 4 - 5 x D	.08 x D	9	119	.0394	.0525	.0653	.0787	.1047	.1307	.1574
		Finish	3 x D	.015 x D	9	107	.0192	.0256	.0319	.0384	.0511	.0637	.0768
	Difficult-to-Machine Titanium Alloys 10-2-3	Peripheral - HEM	≤ 2.5 x D	.08 x D	9	102	.0480	.0640	.0797	.0960	.1277	.1593	.1920
		Peripheral - HEM	> 2.5 - 3.5 x D	.07 x D	9	99	.0432	.0576	.0717	.0864	.1149	.1434	.1728
		Peripheral - HEM	> 3.5 - 4 x D	.06 x D	9	93	.0384	.0512	.0637	.0768	.1021	.1275	.1536
		Finish	3 x D	.01 x D	9	88	.0168	.0224	.0279	.0336	.0447	.0558	.0672
	Hastalloy, Waspalloy	Peripheral - HEM	≤ 1.5 x D	.08 x D	9	30	.1080	.1440	.1793	.2160	.2873	.3585	.4320
		Peripheral - HEM	> 1.5 - 2.5 x D	.08 x D	9	29	.0972	.1296	.1613	.1944	.2585	.3227	.3888
		Peripheral - HEM	> 2.5 - 3.5 x D	.06 x D	9	26	.0864	.1152	.1434	.1728	.2298	.2868	.3456
		Finish	2 x D	.01 x D	9	27	.0576	.0768	.0956	.1152	.1532	.1912	.2304
Inconel 718, Rene 88	Peripheral - HEM	≤ 1.5 x D	.07 x D	9	29	.1092	.1456	.1813	.2184	.2904	.3625	.4368	
	Peripheral - HEM	> 1.5 - 2.5 x D	.06 x D	9	27	.0983	.1310	.1631	.1965	.2614	.3263	.3931	
	Peripheral - HEM	> 2.5 - 3 x D	.06 x D	9	26	.0874	.1165	.1450	.1747	.2324	.2900	.3494	
	Finish	2 x D	.01 x D	9	26	.0552	.0736	.0916	.1104	.1468	.1832	.2208	

D = Tool Diameter HEM = High-efficiency machining (chip thinning calculations have already been applied to HEM parameters)

- D** Tool Diameter
- Z** Number of Flutes
- RPM** Revolutions per Minute
- SFM** Surface Feet per Minute
- M/min** Surface Meters per Minute
- IPM** Inches per Minute
- MMPM** Millimeters per Minute
- IPT** Inch per Tooth
- MMPT** Millimeters per Tooth
- MRR** Metal Removal Rate
- RDOC** Radial Depth of Cut
- ADOC** Axial Depth of Cut

Technical Resources

Information on tips and adjustments for the following milling operations can be found in our Technical Resources section beginning on page 134.

- HEM slotting
- Face milling
- Helical entry ramping
- Straight line ramping
- Long tool projection adjustments
- Ball nose milling adjustments
- Other helpful tips and calculations

IPT11 POW•R•PATH

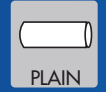

For high-efficiency machining (HEM) in materials ranging from low carbon steels to hi-temp alloys. Built for results with 11 cutting edges to yield incredible feed rates. Engineered specifically for HEM tool paths, the IPT11 has a very thick core for extra stability when machining materials up to 3.5 x the tool diameter deep.

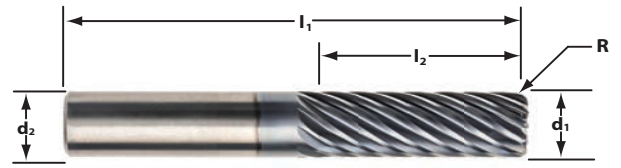

in: d1: +0.000 / -0.002 d2: -0.0001 / -0.0004
mm: d1: +0.000 / -0.050 d2: -0.0025 / -0.0100



Note that the IPT11 is not designed for light-duty machines and should only be run in machines with adequate spindle torque and horsepower.

Cutter Dia d1	Shank Dia d2	Max Axial Depth xD	Length of Cut l2	Overall Length l1	Order Code by Corner Radius		
					.030 CR	.060 CR	.125 CR
1/2	1/2	2	1	3	0340615	0340616	-
		2.5	1-1/4	3-1/4	0340617	0340618	-
		3	1-1/2	3-1/2	0340619	0340620	-
		3.5	1-3/4	4	0340621	0340622	-
5/8	5/8	2	1-1/4	3-1/2	0340623	0340624	-
		2.5	1-9/16	4	0340625	0340626	-
		3	1-7/8	4	0340627	0340628	-
		3.5	2-3/16	4-1/2	0340629	0340630	-
3/4	3/4	2	1-1/2	4	0340631	0340632	0340633
		2.5	1-7/8	4-1/2	0340634	0340635	0340636
		3	2-1/4	5	0340637	0340638	0340639
		3.5	2-5/8	5	0340640	0340641	0340642
1	1	2	2	5	0340643	0340644	0340645
		2.5	2-1/2	5-1/2	0340646	0340647	0340648
		3	3	6	0340649	0340650	0340651
		3.5	3-1/2	6-1/2	0340652	0340653	0340654
1-1/4	1-1/4	2	2-1/2	5-1/2	0340655	0340656	0340657
		2.5	3-1/8	6-1/2	0340658	0340659	0340660

Cutter Dia d1	Shank Dia d2	Max Axial Depth xD	Length of Cut l2	Overall Length l1	Order Code by Corner Radius		
					1.0 CR	1.5 CR	3.0 CR
12	12	2	24	75	0340854	0340855	-
		2.5	30	83	0340856	0340857	-
		3	36	88	0340858	0340859	-
		3.5	42	93	0340860	0340861	-
16	16	2	32	92	0340862	0340863	-
		2.5	40	100	0340864	0340865	-
		3	48	110	0340866	0340867	-
		3.5	56	110	0340868	0340869	-
20	20	2	40	104	0340870	0340871	0340872
		2.5	50	115	0340873	0340874	0340875
		3	60	125	0340876	0340877	0340878
		3.5	70	135	0340879	0340880	0340881

D = Tool Diameter

IPC11 POW•R•PATH



For high-efficiency machining (HEM) in materials ranging from low carbon steels to hi-temp alloys. Adds the benefits of the unique **Chip Management System (CMS)** to the versatility of the IPT11 design. Breaks up long, stringy chips, which eliminates recutting chips and chip packing, and allows for deep, free cutting tool movement in a variety of materials. The results are great chip control and very high metal removal rates.

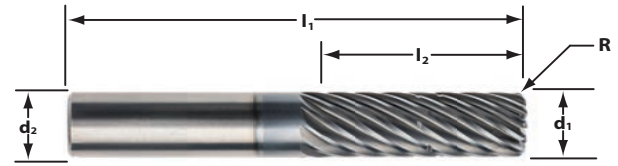

in: $d1: +0.000 / -0.002$ $d2: -0.0001 / -0.0004$
 mm: $d1: +0.000 / -0.050$ $d2: -0.0025 / -0.0100$

Note that the IPT11 is not designed for light-duty machines and should only be run in machines with adequate spindle torque and horsepower.







Cutter Dia d1	Shank Dia d2	Max Axial Depth xD	Length of Cut I2	Overall Length I1	Order Code by Corner Radius		
					.030 CR	.060 CR	.125 CR
1/2	1/2	3	1-1/2	3-1/2	0340661	0340662	-
		3.5	1-3/4	4	0340663	0340664	-
5/8	5/8	2.5	1-9/16	4	0340665	0340666	-
		3	1-7/8	4	0340667	0340668	-
		3.5	2-3/16	4-1/2	0340669	0340670	-
3/4	3/4	2	1-1/2	4	0340671	0340672	0340673
		2.5	1-7/8	4-1/2	0340674	0340675	0340676
		3	2-1/4	5	0340677	0340678	0340679
		3.5	2-5/8	5	0340680	0340681	0340682
1	1	2	2	5	0340683	0340684	0340685
		2.5	2-1/2	5-1/2	0340686	0340687	0340688
		3	3	6	0340689	0340690	0340691
		3.5	3-1/2	6-1/2	0340692	0340693	0340694
1-1/4	1-1/4	2	2-1/2	5-1/2	0340695	0340696	0340697
		2.5	3-1/8	6-1/2	0340698	0340699	0340700

Cutter Dia d1	Shank Dia d2	Max Axial Depth xD	Length of Cut I2	Overall Length I1	Order Code by Corner Radius		
					1.0 CR	1.5 CR	3.0 CR
12	12	3	36	88	0340882	0340883	-
		3.5	42	93	0340884	0340885	-
16	16	2.5	40	100	0340886	0340887	-
		3	48	110	0340888	0340889	-
		3.5	56	110	0340890	0340891	-
20	20	2	40	104	0340892	0340893	0340894
		2.5	50	115	0340895	0340896	0340897
		3	60	125	0340898	0340899	0340900
		3.5	70	135	0340901	0340902	0340903

D = Tool Diameter





IPT11/IPC11 Application Guide – Speed & Feed (inch)

ISO Code	Work Material	Type of Cut	Axial DOC	Radial DOC	No. of Flutes	Speed (SFM)	1/2	5/8	3/4	1	1-1/4
	Gray ASTM-A48 Class 20, 25, 30, 35 & 40	Peripheral - HEM	≤ 2 x D	.08 x D	11	365	.0053	.0066	.0080	.0106	.0133
		Peripheral - HEM	> 2 - 3 x D	.07 x D	11	365	.0046	.0058	.0069	.0092	.0115
		Peripheral - HEM	> 3 - 3.5 x D	.07 x D	11	350	.0040	.0050	.0060	.0080	.0100
		Peripheral - HEM	> 3.5 - 4 x D	.065 x D	11	350	.0034	.0043	.0051	.0068	.0085
		Finish	3 x D	.01 x D	11	370	.0022	.0028	.0033	.0044	.0055
	Cast Iron Malleable	Peripheral - HEM	≤ 2 x D	.07 x D	11	375	.0063	.0079	.0095	.0126	.0158
		Peripheral - HEM	> 2 - 3 x D	.07 x D	11	375	.0056	.0070	.0084	.0112	.0140
		Peripheral - HEM	> 3 - 3.5 x D	.07 x D	11	360	.0048	.0060	.0072	.0096	.0120
		Peripheral - HEM	> 3.5 - 4 x D	.07 x D	11	360	.0040	.0050	.0060	.0080	.0100
		Finish	3 x D	.01 x D	11	335	.0023	.0029	.0035	.0046	.0058
	Low Carbon Steels ≤ 38 Rc 1018, 1020, 12L14, 5120, 8620	Peripheral - HEM	≤ 2 x D	.07 x D	11	550	.0055	.0069	.0083	.0110	.0138
		Peripheral - HEM	> 2 - 3 x D	.07 x D	11	530	.0048	.0060	.0072	.0096	.0120
		Peripheral - HEM	> 3 - 3.5 x D	.07 x D	11	515	.0042	.0053	.0063	.0084	.0105
		Peripheral - HEM	> 3.5 - 4 x D	.07 x D	11	505	.0036	.0045	.0054	.0072	.0090
		Finish	3 x D	.01 x D	11	475	.0020	.0025	.0030	.0040	.0050
	Medium Carbon Steels ≤ 48 HRC 1045, 4140, 4340, 5140	Peripheral - HEM	≤ 2 x D	.07 x D	11	530	.0054	.0068	.0081	.0108	.0135
		Peripheral - HEM	> 2 - 3 x D	.07 x D	11	515	.0047	.0059	.0071	.0094	.0118
		Peripheral - HEM	> 3 - 3.5 x D	.07 x D	11	500	.0041	.0051	.0062	.0082	.0103
		Peripheral - HEM	> 3.5 - 4 x D	.07 x D	11	490	.0035	.0044	.0053	.0070	.0088
		Finish	3 x D	.01 x D	11	455	.0019	.0024	.0029	.0038	.0048
	Tool and Die Steels ≤ 48 Rc A2, D2, O1, S7, P20, H13	Peripheral - HEM	≤ 2 x D	.06 x D	11	445	.0063	.0079	.0095	.0126	.0158
		Peripheral - HEM	> 2 - 3 x D	.06 x D	11	430	.0055	.0069	.0083	.0110	.0138
		Peripheral - HEM	> 3 - 3.5 x D	.06 x D	11	415	.0048	.0060	.0072	.0096	.0120
		Peripheral - HEM	> 3.5 - 4 x D	.06 x D	11	410	.0041	.0051	.0062	.0082	.0103
		Finish	3 x D	.01 x D	11	385	.0020	.0025	.0030	.0040	.0050
	Martensitic & Ferritic Stainless Steels 410, 416, 440	Peripheral - HEM	≤ 2 x D	.06 x D	11	450	.0068	.0085	.0102	.0136	.0170
		Peripheral - HEM	> 2 - 3 x D	.06 x D	11	450	.0060	.0075	.0090	.0120	.0150
		Peripheral - HEM	> 3 - 3.5 x D	.06 x D	11	425	.0054	.0068	.0081	.0108	.0135
		Peripheral - HEM	> 3.5 - 4 x D	.06 x D	11	425	.0044	.0055	.0066	.0088	.0110
		Finish	3 x D	.01 x D	11	390	.0023	.0029	.0035	.0046	.0058
	Austenitic Stainless Steels, FeNi Alloys 303, 304, 316, Invar, Kovar	Peripheral - HEM	≤ 2 x D	.06 x D	11	445	.0067	.0084	.0101	.0134	.0168
		Peripheral - HEM	> 2 - 3 x D	.06 x D	11	430	.0059	.0074	.0089	.0118	.0148
		Peripheral - HEM	> 3 - 3.5 x D	.06 x D	11	415	.0052	.0065	.0078	.0104	.0130
		Peripheral - HEM	> 3.5 - 4 x D	.06 x D	11	410	.0043	.0054	.0065	.0086	.0108
		Finish	3 x D	.01 x D	11	385	.0025	.0031	.0038	.0050	.0063
	Precipitation Hardening Stainless Steels 17-4, 15-5	Peripheral - HEM	≤ 2 x D	.06 x D	11	435	.0068	.0085	.0102	.0136	.0170
		Peripheral - HEM	> 2 - 3 x D	.06 x D	11	420	.0060	.0075	.0090	.0120	.0150
		Peripheral - HEM	> 3 - 3.5 x D	.06 x D	11	405	.0052	.0065	.0078	.0104	.0130
		Peripheral - HEM	> 3.5 - 4 x D	.06 x D	11	400	.0043	.0054	.0065	.0086	.0108
		Finish	3 x D	.01 x D	11	375	.0022	.0028	.0033	.0044	.0055
	Titanium Alloys 6Al-4V, 6-2-4	Peripheral - HEM	≤ 2 x D	.06 x D	11	425	.0060	.0075	.0090	.0120	.0150
		Peripheral - HEM	> 2 - 3 x D	.06 x D	11	415	.0043	.0054	.0065	.0086	.0108
		Peripheral - HEM	> 3 - 3.5 x D	.06 x D	11	395	.0042	.0053	.0063	.0084	.0105
		Peripheral - HEM	> 3.5 - 4 x D	.06 x D	11	395	.0039	.0049	.0059	.0078	.0098
		Finish	3 x D	.015 x D	11	370	.0023	.0029	.0035	.0046	.0058
	Difficult-to-Machine Titanium Alloys 10-2-3	Peripheral - HEM	≤ 2 x D	0.06 x D	11	350	.0059	.0074	.0089	.0118	.0148
		Peripheral - HEM	> 2 - 3 x D	0.06 x D	11	330	.0042	.0053	.0063	.0084	.0105
		Peripheral - HEM	> 3 - 3.5 x D	0.055 x D	11	315	.0041	.0051	.0062	.0082	.0103
	Precipitation Hardening Stainless Steel  13-8	Peripheral - HEM	> 3.5 - 4 x D	0.05 x D	11	310	.0038	.0048	.0057	.0076	.0095
		Finish	3 x D	.01 x D	11	300	.0020	.0025	.0030	.0040	.0050
		Peripheral - HEM	≤ 2 x D	.07 x D	11	105	.0090	.0113	.0135	.0180	.0225
	Hastalloy, Waspalloy	Peripheral - HEM	> 2 - 3 x D	.065 x D	11	100	.0081	.0101	.0122	.0162	.0203
		Peripheral - HEM	> 3 - 3.5 x D	.055 x D	11	90	.0072	.0090	.0108	.0144	.0180
		Peripheral - HEM	> 3.5 - 4 x D	.055 x D	11	90	.0065	.0081	.0097	.0130	.0162
		Finish	3 x D	.01 x D	11	90	.0047	.0059	.0071	.0094	.0118
Peripheral - HEM		≤ 2 x D	.065 x D	11	100	.0062	.0078	.0093	.0124	.0155	
Inconel 718, Rene 88	Peripheral - HEM	> 2 - 3 x D	.06 x D	11	95	.0060	.0075	.0090	.0120	.0150	
	Peripheral - HEM	> 3 - 3.5 x D	.05 x D	11	95	.0060	.0075	.0090	.0120	.0150	
	Peripheral - HEM	> 3.5 - 4 x D	.05 x D	11	95	.0052	.0065	.0078	.0104	.0130	
	Finish	3 x D	.01 x D	11	90	.0032	.0040	.0048	.0064	.0080	

D = Tool Diameter HEM = High-efficiency machining (chip thinning calculations have already been applied to HEM parameters)

≈ Approximately Equals < Less Than
 ≤ Less Than or Equal To > Greater Than
 ≥ Greater Than or Equal To = Equals
 x Multiply

IPT11/IPC11 Application Guide – Speed & Feed (metric)

ISO Code	Work Material	Type of Cut	Axial DOC	Radial DOC	No. of Flutes	Speed (M/min)	12.0	16.0	20.0
	Gray ASTM-A48 Class 20, 25, 30, 35 & 40	Peripheral - HEM	≤ 2 x D	.08 x D	11	111	.1272	.1692	.2111
		Peripheral - HEM	> 2 - 3 x D	.07 x D	11	111	.1104	.1468	.1832
		Peripheral - HEM	> 3 - 3.5 x D	.07 x D	11	107	.0960	.1277	.1593
		Peripheral - HEM	> 3.5 - 4 x D	.065 x D	11	107	.0816	.1085	.1354
		Finish	3 x D	.01 x D	11	113	.0528	.0702	.0876
	Cast Iron Malleable	Peripheral - HEM	≤ 2 x D	.07 x D	11	114	.1512	.2011	.2510
		Peripheral - HEM	> 2 - 3 x D	.07 x D	11	114	.1344	.1787	.2231
		Peripheral - HEM	> 3 - 3.5 x D	.07 x D	11	110	.1152	.1532	.1912
		Peripheral - HEM	> 3.5 - 4 x D	.07 x D	11	110	.0960	.1277	.1593
		Finish	3 x D	.01 x D	11	102	.0552	.0734	.0916
	Low Carbon Steels ≤ 38 Rc 1018, 1020, 12L14, 5120, 8620	Peripheral - HEM	≤ 2 x D	.07 x D	11	168	.1320	.1755	.2191
		Peripheral - HEM	> 2 - 3 x D	.07 x D	11	162	.1152	.1532	.1912
		Peripheral - HEM	> 3 - 3.5 x D	.07 x D	11	157	.1008	.1341	.1673
		Peripheral - HEM	> 3.5 - 4 x D	.07 x D	11	154	.0864	.1149	.1434
		Finish	3 x D	.01 x D	11	145	.0480	.0638	.0797
	Medium Carbon Steels ≤ 48 HRC 1045, 4140, 4340, 5140	Peripheral - HEM	≤ 2 x D	.07 x D	11	162	.1296	.1724	.2151
		Peripheral - HEM	> 2 - 3 x D	.07 x D	11	157	.1128	.1500	.1872
		Peripheral - HEM	> 3 - 3.5 x D	.07 x D	11	152	.0984	.1309	.1633
		Peripheral - HEM	> 3.5 - 4 x D	.07 x D	11	149	.0840	.1117	.1394
		Finish	3 x D	.01 x D	11	139	.0456	.0606	.0757
	Tool and Die Steels ≤ 48 Rc A2, D2, O1, S7, P20, H13	Peripheral - HEM	≤ 2 x D	.06 x D	11	136	.1512	.2011	.2510
		Peripheral - HEM	> 2 - 3 x D	.06 x D	11	131	.1320	.1755	.2191
		Peripheral - HEM	> 3 - 3.5 x D	.06 x D	11	126	.1152	.1532	.1912
		Peripheral - HEM	> 3.5 - 4 x D	.06 x D	11	125	.0984	.1309	.1633
		Finish	3 x D	.01 x D	11	117	.0480	.0638	.0797
		Martensitic & Ferritic Stainless Steels 410, 416, 440	Peripheral - HEM	≤ 2 x D	.06 x D	11	137	.1608	.2138
Peripheral - HEM			> 2 - 3 x D	.06 x D	11	137	.1416	.1883	.2350
Peripheral - HEM			> 3 - 3.5 x D	.06 x D	11	130	.1248	.1660	.2072
Peripheral - HEM			> 3.5 - 4 x D	.06 x D	11	130	.1032	.1372	.1713
Finish			3 x D	.01 x D	11	119	.0600	.0798	.0996
Austenitic Stainless Steels, FeNi Alloys 303, 304, 316, Invar, Kovar		Peripheral - HEM	≤ 2 x D	.06 x D	11	136	.1632	.2170	.2709
		Peripheral - HEM	> 2 - 3 x D	.06 x D	11	131	.1440	.1915	.2390
		Peripheral - HEM	> 3 - 3.5 x D	.06 x D	11	126	.1296	.1724	.2151
		Peripheral - HEM	> 3.5 - 4 x D	.06 x D	11	125	.1056	.1404	.1753
		Finish	3 x D	.01 x D	11	117	.0552	.0734	.0916
Precipitation Hardening Stainless Steels 17-4, 15-5		Peripheral - HEM	≤ 2 x D	.06 x D	11	133	.1632	.2170	.2709
		Peripheral - HEM	> 2 - 3 x D	.06 x D	11	128	.1440	.1915	.2390
		Peripheral - HEM	> 3 - 3.5 x D	.06 x D	11	123	.1248	.1660	.2072
		Peripheral - HEM	> 3.5 - 4 x D	.06 x D	11	122	.1032	.1372	.1713
		Finish	3 x D	.01 x D	11	114	.0528	.0702	.0876
	Titanium Alloys 6Al-4V, 6-2-4	Peripheral - HEM	≤ 2 x D	.06 x D	11	130	.1440	.1915	.2390
		Peripheral - HEM	> 2 - 3 x D	.06 x D	11	126	.1032	.1372	.1713
		Peripheral - HEM	> 3 - 3.5 x D	.06 x D	11	120	.1008	.1341	.1673
		Peripheral - HEM	> 3.5 - 4 x D	.06 x D	11	120	.0936	.1245	.1554
		Finish	3 x D	.015 x D	11	113	.0552	.0734	.0916
	Difficult-to-Machine Titanium Alloys 10-2-3	Peripheral - HEM	≤ 2 x D	0.06 x D	11	107	.1416	.1883	.2350
		Peripheral - HEM	> 2 - 3 x D	0.06 x D	11	101	.1008	.1341	.1673
		Peripheral - HEM	> 3 - 3.5 x D	0.055 x D	11	96	.0984	.1309	.1633
		Peripheral - HEM	> 3.5 - 4 x D	0.05 x D	11	94	.0912	.1213	.1514
		Finish	3 x D	.01 x D	11	91	.0480	.0638	.0797
	Precipitation Hardening Stainless Steel  13-8	Peripheral - HEM	≤ 2 x D	.07 X D	11	32	.2160	.2873	.3585
		Peripheral - HEM	> 2 - 3 x D	.065 x D	11	30	.1944	.2585	.3227
		Peripheral - HEM	> 3 - 3.5 x D	.055 x D	11	27	.1728	.2298	.2868
		Peripheral - HEM	> 3.5 - 4 x D	.055 x D	11	27	.1555	.2068	.2581
		Finish	3 x D	.01 x D	11	27	.1128	.1500	.1872
	Hastalloy, Waspalloy	Peripheral - HEM	≤ 2 x D	.065 x D	11	30	.1488	.1979	.2470
		Peripheral - HEM	> 2 - 3 x D	.06 x D	11	29	.1440	.1915	.2390
		Peripheral - HEM	> 3 - 3.5 x D	.05 x D	11	29	.1440	.1915	.2390
		Peripheral - HEM	> 3.5 - 4 x D	.05 x D	11	29	.1248	.1660	.2072
		Finish	3 x D	.01 x D	11	27	.0768	.1021	.1275
Inconel 718, Rene 88	Peripheral - HEM	≤ 2 x D	.065 x D	11	30	.1488	.1979	.2470	
	Peripheral - HEM	> 2 - 3 x D	.06 x D	11	29	.1440	.1915	.2390	
	Peripheral - HEM	> 3 - 3.5 x D	.05 x D	11	29	.1440	.1915	.2390	
	Peripheral - HEM	> 3.5 - 4 x D	.05 x D	11	29	.1248	.1660	.2072	
	Finish	3 x D	.01 x D	11	27	.0768	.1021	.1275	

D = Tool Diameter HEM = High-efficiency machining (chip thinning calculations have already been applied to HEM parameters)

Information on tips and adjustments can be found in our Technical Resources section beginning on page 134.

IPT13 POW•R•PATH



For high-efficiency machining (HEM) in materials ranging from low carbon steels to hi-temp alloys. The IPT13 offers the most cutting edges available in the POW•R•PATH line. The 13 flutes yield incredible metal removal rates and tool life. Engineered specifically for HEM tool paths, the IPT13 has a very thick core for extra stability when machining materials up to 3.5 x the tool diameter deep.

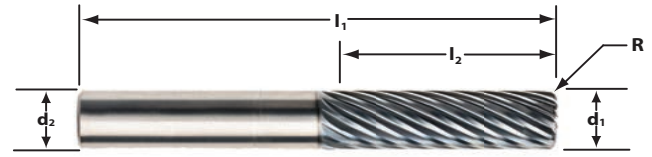

in: $d1: +0.000 / -0.002$ $d2: -0.0001 / -0.0004$
mm: $d1: +0.000 / -0.050$ $d2: -0.0025 / -0.0100$

Note that the IPT13 is not designed for light-duty machines and should only be run in machines with adequate spindle torque and horsepower.



Cutter Dia d1	Shank Dia d2	Max Axial Depth xD	Length of Cut L2	Overall Length L1	Order Code by Corner Radius		
					.030 CR	.060 CR	.125 CR
1/2	1/2	2	1	3	0340701	0340702	-
		2.5	1-1/4	3-1/4	0340703	0340704	-
		3	1-1/2	3-1/2	0340705	0340706	-
		3.5	1-3/4	4	0340707	0340708	-
5/8	5/8	2	1-1/4	3-1/2	0340709	0340710	-
		2.5	1-9/16	4	0340711	0340712	-
		3	1-7/8	4	0340713	0340714	-
		3.5	2-3/16	4-1/2	0340715	0340716	-
3/4	3/4	2	1-1/2	4	0340717	0340718	0340719
		2.5	1-7/8	4-1/2	0340720	0340721	0340722
		3	2-1/4	5	0340723	0340724	0340725
		3.5	2-5/8	5	0340726	0340727	0340728
1	1	2	2	5	0340729	0340730	0340731
		2.5	2-1/2	5-1/2	0340732	0340733	0340734
		3	3	6	0340735	0340736	0340737
		3.5	3-1/2	6-1/2	0340738	0340739	0340740
1-1/4	1-1/4	2	2-1/2	5-1/2	0340741	0340742	0340743
		2.5	3-1/8	6-1/2	0340744	0340745	0340746

Cutter Dia d1	Shank Dia d2	Max Axial Depth xD	Length of Cut L2	Overall Length L1	Order Code by Corner Radius		
					1.0 CR	1.5 CR	3.0 CR
12	12	2	24	75	0340904	0340905	-
		2.5	30	83	0340906	0340907	-
		3	36	88	0340908	0340909	-
		3.5	42	93	0340910	0340911	-
16	16	2	32	92	0340912	0340913	-
		2.5	40	100	0340914	0340915	-
		3	48	110	0340916	0340917	-
		3.5	56	110	0340918	0340919	-
20	20	2	40	104	0340920	0340921	0340922
		2.5	50	115	0340923	0340924	0340925
		3	60	125	0340926	0340927	0340928
		3.5	70	135	0340929	0340930	0340931

D = Tool Diameter

IPC13 POW•R•PATH



For high-efficiency machining (HEM) in materials ranging from low carbon steels to hi-temp alloys. Adds the benefits of the unique **Chip Management System (CMS)** to the versatility of the IPT13 design. Breaks up long, stringy chips, which eliminates recutting chips and chip packing, and allows for deep, free cutting tool movement in a variety of materials. The results are great chip control and very high metal removal rates.

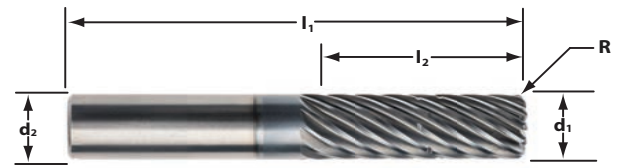

in: d1: +0.000 / -0.002 d2: -0.0001 / -0.0004
mm: d1: +0.000 / -0.050 d2: -0.0025 / -0.0100





Note that the IPT13 is not designed for light-duty machines and should only be run in machines with adequate spindle torque and horsepower.

Cutter Dia d1	Shank Dia d2	Max Axial Depth xD	Length of Cut I2	Overall Length I1	Order Code by Corner Radius		
					.030 CR	.060 CR	.125 CR
1/2	1/2	3	1-1/2	3-1/2	0340747	0340748	-
		3.5	1-3/4	4	0340749	0340750	-
5/8	5/8	2.5	1-9/16	4	0340751	0340752	-
		3	1-7/8	4	0340753	0340754	-
		3.5	2-3/16	4-1/2	0340755	0340756	-
3/4	3/4	2	1-1/2	4	0340757	0340758	0340759
		2.5	1-7/8	4-1/2	0340760	0340761	0340762
		3	2-1/4	5	0340763	0340764	0340765
		3.5	2-5/8	5	0340766	0340767	0340768
1	1	2	2	5	0340769	0340770	0340771
		2.5	2-1/2	5-1/2	0340772	0340773	0340774
		3	3	6	0340775	0340776	0340777
		3.5	3-1/2	6-1/2	0340778	0340779	0340780
1-1/4	1-1/4	2	2-1/2	5-1/2	0340781	0340782	0340783
		2.5	3-1/8	6-1/2	0340784	0340785	0340786

Cutter Dia d1	Shank Dia d2	Max Axial Depth xD	Length of Cut I2	Overall Length I1	Order Code by Corner Radius		
					1.0 CR	1.5 CR	3.0 CR
12	12	3	36	88	0340932	0340933	-
		3.5	42	93	0340934	0340935	-
16	16	2.5	40	100	0340936	0340937	-
		3	48	110	0340938	0340939	-
		3.5	56	110	0340940	0340941	-
20	20	2	40	104	0340942	0340943	0340944
		2.5	50	115	0340945	0340946	0340947
		3	60	125	0340948	0340949	0340950
		3.5	70	135	0340951	0340952	0340953

D = Tool Diameter





IPT13/IPC13 Application Guide – Speed & Feed (inch)

ISO Code	Work Material	Type of Cut	Axial DOC	Radial DOC	No. of Flutes	Speed (SFM)	Feed (Inches per Tooth)				
							1/2	5/8	3/4	1	1-1/4
	Gray ASTM-A48 Class 20, 25, 30, 35 & 40	Peripheral - HEM	≤ 2 x D	.07 x D	13	370	.0045	.0056	.0068	.0090	.0113
		Peripheral - HEM	> 2 - 3 x D	.07 x D	13	370	.0040	.0050	.0060	.0080	.0100
		Peripheral - HEM	> 3 - 3.5 x D	.07 x D	13	360	.0034	.0043	.0051	.0068	.0085
		Peripheral - HEM	> 3.5 - 4 x D	.06 x D	13	360	.0030	.0038	.0045	.0060	.0075
		Finish	3 x D	.01 x D	13	365	.0020	.0025	.0030	.0040	.0050
	Cast Iron Malleable	Peripheral - HEM	≤ 2 x D	.07 x D	13	380	.0048	.0060	.0072	.0096	.0120
		Peripheral - HEM	> 2 - 3 x D	.07 x D	13	380	.0042	.0053	.0063	.0084	.0105
		Peripheral - HEM	> 3 - 3.5 x D	.07 x D	13	365	.0039	.0049	.0059	.0078	.0098
		Peripheral - HEM	> 3.5 - 4 x D	.07 x D	13	365	.0036	.0045	.0054	.0072	.0090
		Finish	3 x D	.01 x D	13	340	.0017	.0021	.0026	.0034	.0043
	Low Carbon Steels ≤ 38 Rc 1018, 1020, 12L14, 5120, 8620	Peripheral - HEM	≤ 2 x D	.07 x D	13	450	.0044	.0055	.0066	.0088	.0110
		Peripheral - HEM	> 2 - 3 x D	.07 x D	13	430	.0039	.0049	.0059	.0078	.0098
		Peripheral - HEM	> 3 - 3.5 x D	.07 x D	13	420	.0036	.0045	.0054	.0072	.0090
		Peripheral - HEM	> 3.5 - 4 x D	.07 x D	13	410	.0034	.0043	.0051	.0068	.0085
		Finish	3 x D	.01 x D	13	395	.0017	.0021	.0026	.0034	.0043
	Medium Carbon Steels ≤ 48 HRC 1045, 4140, 4340, 5140	Peripheral - HEM	≤ 2 x D	.06 x D	13	405	.0044	.0055	.0066	.0088	.0110
		Peripheral - HEM	> 2 - 3 x D	.06 x D	13	405	.0041	.0051	.0062	.0082	.0103
		Peripheral - HEM	> 3 - 3.5 x D	.05 x D	13	405	.0039	.0049	.0059	.0078	.0098
		Peripheral - HEM	> 3.5 - 4 x D	.05 x D	13	405	.0036	.0045	.0054	.0072	.0090
		Finish	3 x D	.01 x D	13	370	.0017	.0021	.0026	.0034	.0043
	Tool and Die Steels ≤ 48 Rc A2, D2, O1, S7, P20, H13	Peripheral - HEM	≤ 2 x D	.06 x D	13	420	.0045	.0056	.0068	.0090	.0113
		Peripheral - HEM	> 2 - 3 x D	.06 x D	13	420	.0040	.0050	.0060	.0080	.0100
		Peripheral - HEM	> 3 - 3.5 x D	.05 x D	13	415	.0037	.0046	.0056	.0074	.0093
		Peripheral - HEM	> 3.5 - 4 x D	.05 x D	13	415	.0035	.0044	.0053	.0070	.0088
		Finish	3 x D	.01 x D	13	385	.0015	.0019	.0023	.0030	.0038
	Martensitic & Ferritic Stainless Steels 410, 416, 440	Peripheral - HEM	≤ 2 x D	.06 x D	13	460	.0050	.0063	.0075	.0100	.0125
		Peripheral - HEM	> 2 - 3 x D	.06 x D	13	460	.0048	.0060	.0072	.0096	.0120
		Peripheral - HEM	> 3 - 3.5 x D	.06 x D	13	450	.0040	.0050	.0060	.0080	.0100
		Peripheral - HEM	> 3.5 - 4 x D	.06 x D	13	445	.0035	.0044	.0053	.0070	.0088
		Finish	3 x D	.01 x D	13	390	.0018	.0023	.0027	.0036	.0045
	Austenitic Stainless Steels, FeNi Alloys 303, 304, 316, Invar, Kovar	Peripheral - HEM	≤ 2 x D	.06 x D	13	450	.0041	.0051	.0062	.0082	.0103
		Peripheral - HEM	> 2 - 3 x D	.06 x D	13	450	.0040	.0050	.0060	.0080	.0100
		Peripheral - HEM	> 3 - 3.5 x D	.05 x D	13	450	.0037	.0046	.0056	.0074	.0093
		Peripheral - HEM	> 3.5 - 4 x D	.05 x D	13	445	.0035	.0044	.0053	.0070	.0088
		Finish	3 x D	.01 x D	13	415	.0015	.0019	.0023	.0030	.0038
	Precipitation Hardening Stainless Steels 17-4, 15-5	Peripheral - HEM	> 2 - 3 x D	.06 x D	13	440	.0041	.0051	.0062	.0082	.0103
		Peripheral - HEM	> 3 - 3.5 x D	.05 x D	13	435	.0038	.0048	.0057	.0076	.0095
		Peripheral - HEM	> 3.5 - 4 x D	.05 x D	13	435	.0034	.0043	.0051	.0068	.0085
		Finish	3 x D	.01 x D	13	400	.0017	.0021	.0026	.0034	.0043
			Titanium Alloys 6Al-4V, 6-2-4	Peripheral - HEM	≤ 2 x D	.08 x D	13	395	.0050	.0063	.0075
Peripheral - HEM	> 2 - 3 x D			.07 x D	13	390	.0045	.0056	.0068	.0090	.0113
Peripheral - HEM	> 3 - 3.5 x D			.06 x D	13	380	.0041	.0051	.0062	.0082	.0103
Peripheral - HEM	> 3.5 - 4 x D			.06 x D	13	380	.0034	.0043	.0051	.0068	.0085
Finish	3 x D			.015 x D	13	355	.0022	.0028	.0033	.0044	.0055
Difficult-to-Machine Titanium Alloys 10-2-3	Peripheral - HEM		≤ 2 x D	.06 x D	13	350	.0050	.0063	.0075	.0100	.0125
	Peripheral - HEM		> 2 - 3 x D	.06 x D	13	330	.0036	.0045	.0054	.0072	.0090
	Peripheral - HEM		> 3 - 3.5 x D	.055 x D	13	315	.0035	.0044	.0053	.0070	.0088
	Peripheral - HEM		> 3.5 - 4 x D	.05 x D	13	310	.0032	.0040	.0048	.0064	.0080
	Finish		3 x D	.01 x D	13	300	.0017	.0021	.0026	.0034	.0043
Precipitation Hardening Stainless Steels  13-8	Peripheral - HEM		≤ 2 x D	.07 x D	13	105	.0071	.0089	.0107	.0142	.0178
	Peripheral - HEM		> 2 - 3 x D	.065 x D	13	100	.0064	.0080	.0096	.0128	.0160
	Peripheral - HEM		> 3 - 3.5 x D	.055 x D	13	90	.0062	.0078	.0093	.0124	.0155
	Peripheral - HEM		> 3.5 - 4 x D	.05 x D	13	90	.0057	.0071	.0086	.0114	.0143
	Finish		3 x D	.01 x D	13	90	.0044	.0055	.0066	.0088	.0110
Hastalloy, Waspalloy	Peripheral - HEM		≤ 2 x D	.06 x D	13	100	.0052	.0065	.0078	.0104	.0130
	Peripheral - HEM		> 2 - 3 x D	.05 x D	13	95	.0052	.0065	.0078	.0104	.0130
	Peripheral - HEM		> 3 - 3.5 x D	.05 x D	13	95	.0048	.0060	.0072	.0096	.0120
	Peripheral - HEM		> 3.5 - 4 x D	.04 x D	13	95	.0048	.0060	.0072	.0096	.0120
	Finish		3 x D	.01 x D	13	90	.0023	.0029	.0035	.0046	.0058
Inconel 718, Rene 88	Peripheral - HEM	≤ 2 x D	.06 x D	13	100	.0052	.0065	.0078	.0104	.0130	
	Peripheral - HEM	> 2 - 3 x D	.05 x D	13	95	.0052	.0065	.0078	.0104	.0130	
	Peripheral - HEM	> 3 - 3.5 x D	.05 x D	13	95	.0048	.0060	.0072	.0096	.0120	
	Peripheral - HEM	> 3.5 - 4 x D	.04 x D	13	95	.0048	.0060	.0072	.0096	.0120	
	Finish	3 x D	.01 x D	13	90	.0023	.0029	.0035	.0046	.0058	

D = Tool Diameter HEM = High-efficiency machining (chip thinning calculations have already been applied to HEM parameters)

≈ Approximately Equals < Less Than
 ≤ Less Than or Equal To > Greater Than
 ≥ Greater Than or Equal To = Equals
 x Multiply

IPT13/IPC13 Application Guide – Speed & Feed (metric)

ISO Code	Work Material	Type of Cut	Axial DOC	Radial DOC	No. of Flutes	Speed (M/min)	Feed (MM per Tooth)		
							12.0	16.0	20.0
	Gray ASTM-A48 Class 20, 25, 30, 35 & 40	Peripheral - HEM	≤ 2 x D	.07 x D	13	113	.1080	.1436	.1793
		Peripheral - HEM	> 2 - 3 x D	.07 x D	13	113	.0960	.1277	.1593
		Peripheral - HEM	> 3 - 3.5 x D	.07 x D	13	110	.0816	.1085	.1354
		Peripheral - HEM	> 3.5 - 4 x D	.06 x D	13	110	.0720	.0958	.1195
		Finish	3 x D	.01 x D	13	111	.0480	.0638	.0797
	Cast Iron Malleable	Peripheral - HEM	≤ 2 x D	.07 x D	13	116	.1152	.1532	.1912
		Peripheral - HEM	> 2 - 3 x D	.07 x D	13	116	.1008	.1341	.1673
		Peripheral - HEM	> 3 - 3.5 x D	.07 x D	13	111	.0936	.1245	.1554
		Peripheral - HEM	> 3.5 - 4 x D	.07 x D	13	111	.0864	.1149	.1434
		Finish	3 x D	.01 x D	13	104	.0408	.0543	.0677
	Low Carbon Steels ≤ 38 Rc 1018, 1020, 12L14, 5120, 8620	Peripheral - HEM	≤ 2 x D	.07 x D	13	137	.1056	.1404	.1753
		Peripheral - HEM	> 2 - 3 x D	.07 x D	13	131	.0936	.1245	.1554
		Peripheral - HEM	> 3 - 3.5 x D	.07 x D	13	128	.0864	.1149	.1434
		Peripheral - HEM	> 3.5 - 4 x D	.07 x D	13	125	.0816	.1085	.1354
		Finish	3 x D	.01 x D	13	120	.0408	.0543	.0677
	Medium Carbon Steels ≤ 48 HRC 1045, 4140, 4340, 5140	Peripheral - HEM	≤ 2 x D	.06 x D	13	123	.1056	.1404	.1753
		Peripheral - HEM	> 2 - 3 x D	.06 x D	13	123	.0984	.1309	.1633
		Peripheral - HEM	> 3 - 3.5 x D	.05 x D	13	123	.0936	.1245	.1554
		Peripheral - HEM	> 3.5 - 4 x D	.05 x D	13	123	.0864	.1149	.1434
		Finish	3 x D	.01 x D	13	113	.0408	.0543	.0677
	Tool and Die Steels ≤ 48 Rc A2, D2, O1, S7, P20, H13	Peripheral - HEM	≤ 2 x D	.06 x D	13	128	.1080	.1436	.1793
		Peripheral - HEM	> 2 - 3 x D	.06 x D	13	128	.0960	.1277	.1593
		Peripheral - HEM	> 3 - 3.5 x D	.05 x D	13	126	.0888	.1181	.1474
		Peripheral - HEM	> 3.5 - 4 x D	.05 x D	13	126	.0840	.1117	.1394
		Finish	3 x D	.01 x D	13	117	.0360	.0479	.0598
	Martensitic & Ferritic Stainless Steels 410, 416, 440	Peripheral - HEM	≤ 2 x D	.06 x D	13	140	.0984	.1309	.1633
		Peripheral - HEM	> 2 - 3 x D	.06 x D	13	140	.0960	.1277	.1593
		Peripheral - HEM	> 3 - 3.5 x D	.06 x D	13	137	.0888	.1181	.1474
		Peripheral - HEM	> 3.5 - 4 x D	.06 x D	13	136	.0840	.1117	.1394
		Finish	3 x D	.01 x D	13	119	.0360	.0479	.0598
	Austenitic Stainless Steels, FeNi Alloys 303, 304, 316, Invar, Kovar	Peripheral - HEM	≤ 2 x D	.06 x D	13	137	.1200	.1596	.1992
		Peripheral - HEM	> 2 - 3 x D	.06 x D	13	137	.1152	.1532	.1912
		Peripheral - HEM	> 3 - 3.5 x D	.05 x D	13	137	.0960	.1277	.1593
		Peripheral - HEM	> 3.5 - 4 x D	.05 x D	13	136	.0840	.1117	.1394
		Finish	3 x D	.01 x D	13	126	.0432	.0575	.0717
	Precipitation Hardening Stainless Steels 17-4, 15-5	Peripheral - HEM	≤ 2 x D	.06 x D	13	134	.1080	.1436	.1793
		Peripheral - HEM	> 2 - 3 x D	.06 x D	13	134	.0984	.1309	.1633
		Peripheral - HEM	> 3 - 3.5 x D	.05 x D	13	133	.0912	.1213	.1514
		Peripheral - HEM	> 3.5 - 4 x D	.05 x D	13	133	.0816	.1085	.1354
		Finish	3 x D	.01 x D	13	122	.0408	.0543	.0677
	Titanium Alloys 6Al-4V, 6-2-4	Peripheral - HEM	≤ 2 x D	.08 x D	13	120	.1200	.1596	.1992
		Peripheral - HEM	> 2 - 3 x D	.07 x D	13	119	.1080	.1436	.1793
		Peripheral - HEM	> 3 - 3.5 x D	.06 x D	13	116	.0984	.1309	.1633
		Peripheral - HEM	> 3.5 - 4 x D	.06 x D	13	116	.0816	.1085	.1354
		Finish	3 x D	.015 x D	13	108	.0528	.0702	.0876
	Difficult-to-Machine Titanium Alloys 10-2-3	Peripheral - HEM	≤ 2 x D	.06 x D	13	107	.1200	.1596	.1992
		Peripheral - HEM	> 2 - 3 x D	.06 x D	13	101	.0864	.1149	.1434
		Peripheral - HEM	> 3 - 3.5 x D	.055 x D	13	96	.0840	.1117	.1394
	Precipitation Hardening Stainless Steel  13-8	Peripheral - HEM	> 3.5 - 4 x D	.05 x D	13	94	.0768	.1021	.1275
		Finish	3 x D	.01 x D	13	91	.0408	.0543	.0677
	Hastalloy, Waspalloy	Peripheral - HEM	≤ 2 x D	.07 x D	13	32	.1704	.2266	.2828
		Peripheral - HEM	> 2 - 3 x D	.065 x D	13	30	.1536	.2043	.2550
		Peripheral - HEM	> 3 - 3.5 x D	.055 x D	13	27	.1488	.1979	.2470
		Peripheral - HEM	> 3.5 - 4 x D	.05 x D	13	27	.1368	.1819	.2271
		Finish	3 x D	.01 x D	13	27	.1056	.1404	.1753
	Inconel 718, Rene 88	Peripheral - HEM	≤ 2 x D	.06 x D	13	30	.1248	.1660	.2072
		Peripheral - HEM	> 2 - 3 x D	.05 x D	13	29	.1248	.1660	.2072
		Peripheral - HEM	> 3 - 3.5 x D	.05 x D	13	29	.1152	.1532	.1912
		Peripheral - HEM	> 3.5 - 4 x D	.04 x D	13	29	.1152	.1532	.1912
		Finish	3 x D	.01 x D	13	27	.0552	.0734	.0916

D = Tool Diameter

HEM = High-efficiency machining (chip thinning calculations have already been applied to HEM parameters)

Information on tips and adjustments can be found in our Technical Resources section beginning on page 134.

APT5 POW•R•PATH



For high-efficiency machining (HEM) in aluminum alloys. The APT5 is the POW•R•PATH tool that applies to aluminum alloys the same HEM tool paths that work very well in ferrous materials. Engineered with both a solid core for stability and chip evacuation space for high feed rates. The unique cutting edge design combined with 5 flutes and the extra-durable taC coating generates incredibly high metal removal rates.

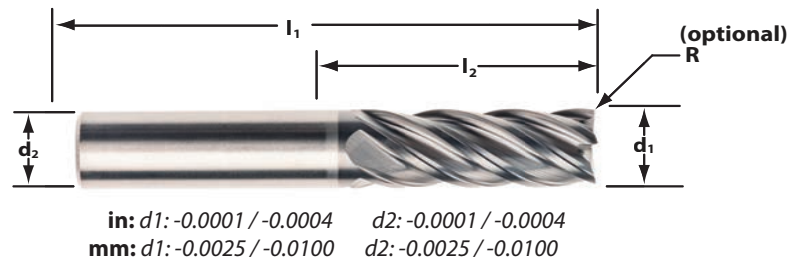

Cutter Dia d1	Shank Dia d2	Max Axial Depth xD	Length of Cut I2	Overall Length I1	Order Code SQ	Order Code by Corner Radius						
						.015 CR	.030 CR	.060 CR	.090 CR	.125 CR	.187 CR	.250 CR
1/4	1/4	2	1/2	2	0339588	0339589	0339590	0339591	-	-	-	-
		3	3/4	2-1/2	0339592	0339593	0339594	0339595	-	-	-	-
		4	1	3	0339596	0339597	0339598	-	-	-	-	-
3/8	3/8	2	3/4	2-1/2	0339599	0339600	0339601	0339602	0339603	-	-	-
		3	1-1/8	3	0339604	0339605	0339606	0339607	0339608	-	-	-
		4	1-1/2	3-1/2	0339609	0339610	0339611	-	-	-	-	-
1/2	1/2	2	1	3	0339612	0339613	0339614	0339615	0339616	0339617	-	-
		2.5	1-1/4	3-1/4	0339618	0339619	0339620	0339621	0339622	0339623	-	-
		3	1-1/2	3-1/2	0339624	0339625	0339626	0339627	0339628	0339629	-	-
		3.5	1-3/4	4	0339630	0339631	0339632	0339633	-	0339634	-	-
		4	2	4	0339635	0339636	0339637	0339638	-	0339639	-	-
5/8	5/8	2	1-1/4	3-1/2	0339640	-	0339641	0339642	0339643	0339644	0339645	-
		3	1-7/8	4	0339646	-	0339647	0339648	0339649	0339650	0339651	-
		4	2-1/2	5	0339652	-	0339653	-	-	0339654	-	-
3/4	3/4	2	1-1/2	4	0339655	-	0339656	0339657	0339658	0339659	0339660	0339661
		2.5	1-7/8	4-1/2	0339662	-	0339663	0339664	-	0339665	-	-
		3	2-1/4	5	0339666	-	0339667	0339668	0339669	0339670	0339671	0339672
		3.5	2-5/8	5	0339673	-	0339674	0339675	-	0339676	-	-
		4	3	6	0339677	-	0339678	0339679	0339680	0339681	-	0339682
1	1	2	2	5	0339683	-	0339684	-	-	0339685	0339686	0339687
		3	3	6	0339688	-	0339689	-	-	0339690	0339691	0339692
		4	4	7	0339693	-	0339694	-	-	0339695	-	0339696

D = Tool Diameter

Cutter Dia d1	Shank Dia d2	Max Axial Depth xD	Length of Cut l2	Overall Length l1	Order Code SQ	Order Code by Corner Radius						
						0.5 CR	1.0 CR	1.5 CR	2.0 CR	2.5 CR	3.0 CR	4.0 CR
6	6	2	12	57	0339786	0339787	0339788	0339789	-	-	-	-
		3	18	63	0339790	0339791	0339792	0339793	-	-	-	-
		4	24	75	0339794	0339795	0339796	0339797	-	-	-	-
8	8	2	16	58	0339798	0339799	0339800	0339801	-	-	-	-
		3	24	63	0339802	0339803	0339804	0339805	-	-	-	-
		4	32	75	0339806	0339807	0339808	0339809	-	-	-	-
10	10	2	20	66	0339810	0339811	0339812	0339813	0339814	-	-	-
		3	30	75	0339815	0339816	0339817	0339818	0339819	-	-	-
		4	40	88	0339820	0339821	0339822	0339823	0339824	-	-	-
12	12	2	24	75	0339825	0339826	0339827	0339828	0339829	0339830	0339831	-
		2.5	30	83	0339832	0339833	0339834	0339835	0339836	0339837	0339838	-
		3	36	88	0339839	0339840	0339841	0339842	0339843	0339844	0339845	-
		3.5	42	93	0339846	0339847	0339848	0339849	-	-	0339850	-
		4	48	100	0339851	0339852	0339853	0339854	0339855	0339856	0339857	-
16	16	2	32	92	0339858	-	0339859	0339860	0339861	0339862	0339863	0339864
		3	48	110	0339865	-	0339866	0339867	0339868	0339869	0339870	-
		4	64	125	0339871	-	0339872	0339873	0339874	0339875	0339876	0339877
20	20	2	40	104	0339878	-	0339879	0339880	0339881	0339882	0339883	0339884
		2.5	50	115	0339885	-	0339886	0339887	-	-	0339888	-
		3	60	125	0339889	-	0339890	0339891	0339892	0339893	0339894	0339895
		3.5	70	135	0339896	-	0339897	0339898	-	-	0339899	-
		4	80	150	0339900	-	0339901	0339902	0339903	0339904	0339905	0339906

D = Tool Diameter

TOOL TIP

AP5: Pushing the Limits of Productivity.

The APT5 and APC5 POW•R•PATH end mills bring the concept of HEM tool paths to machining aluminum alloys. The unique AP design cleaves through aluminum at very high metal removal rates without needing a lot of horsepower, making the AP end mills extremely versatile. Adding to the AP's versatility are:

- Many corner radius options.
- 5 flutes for excellent surface finishes.
- The taC coating that protects the cutting edges to ensure long tool life — even in high-silicon aluminums.
- The Chip Management System (CMS) option that stops chip pollution by breaking the cut material into manageable lengths, eliminating chip packing.



APT5N POW•R•PATH



For high-efficiency machining (HEM) in aluminum alloys. Adding a necked shank to the APT5 design offers a high-performance tool that permits clearance in deeper cavities and easier machining against tight walls. Neck relief and short flute length combine to increase end mill stability in the cut for more precise tolerances. Great for work in pockets.

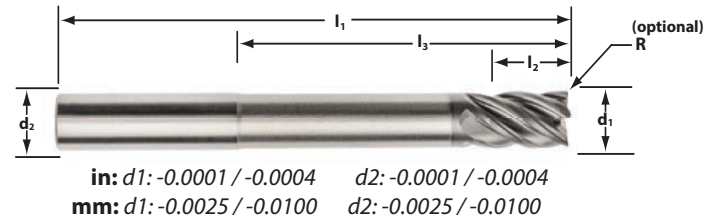

Cutter Dia d1	Shank Dia d2	Length of Cut L2	Reach LBS L3	Overall Length L1	Order Code SQ	Order Code by Corner Radius					
						.015 CR	.030 CR	.060 CR	.090 CR	.125 CR	.250 CR
1/4	1/4	3/8	7/8	2-1/2	0339697	0339698	0339699	0339700	-	-	-
			1-3/8	3	0339701	0339702	0339703	0339704	-	-	-
			2-1/4	4	0339705	0339706	0339707	-	-	-	-
3/8	3/8	9/16	1-1/16	2-1/2	0339708	0339709	0339710	0339711	0339712	-	-
			1-1/8	3	0339713	0339714	0339715	0339716	0339717	-	-
			2-3/16	4	0339718	0339719	0339720	-	-	-	-
1/2	1/2	3/4	1-1/4	3	0339721	0339722	0339723	0339724	0339725	0339726	-
			2-1/8	4	0339727	0339728	0339729	0339730	0339731	0339732	-
			3-1/8	5	0339733	0339734	0339735	0339736	0339737	0339738	-
			4-1/8	6	0339739	0339740	0339741	0339742	-	0339743	-
5/8	5/8	15/16	1-9/16	4	0339744	-	0339745	0339746	0339747	0339748	-
			2-3/16	5	0339749	-	0339750	0339751	0339752	0339753	-
			3-3/16	6	0339754	-	0339755	-	-	0339756	-
3/4	3/4	1-1/8	1-5/8	4	0339757	-	0339758	0339759	0339760	0339761	0339762
			2-1/4	5	0339763	-	0339764	0339765	0339766	0339767	0339768
			3-1/4	6	0339769	-	0339770	0339771	-	0339772	0339773
1	1	1-1/2	2-3/8	5	0339774	-	0339775	-	-	0339776	0339777
			3-1/8	6	0339778	-	0339779	-	-	0339780	0339781
			4-1/8	7	0339782	-	0339783	-	-	0339784	0339785

Cutter Dia d1	Shank Dia d2	Length of Cut L2	Reach LBS L3	Overall Length L1	Order Code SQ	Order Code by Corner Radius						
						0.5 CR	1.0 CR	1.5 CR	2.0 CR	2.5 CR	3.0 CR	4.0 CR
6	6	9	26	63	0339907	0339908	0339909	0339910	-	-	-	-
			32	75	0339911	0339912	0339913	0339914	-	-	-	-
8	8	12	34	75	0339915	0339916	0339917	0339918	-	-	-	-
			32	75	0856027	0853402	0853403	0853404	0853405	-	-	-
10	10	15	42	88	0339919	0339920	0339921	0339922	0339923	-	-	-
			52	100	0339924	0339925	0339926	0339927	0339928	-	-	-
			38	88	0339929	0339930	0339931	0339932	0339933	0339934	0339935	-
12	12	18	50	100	0339936	0339937	0339938	0339939	0339940	0339941	0339942	-
			62	125	0856028	0853406	0853407	0853408	0853409	0853410	0853411	-
			50	110	0339943	-	0339944	0339945	0339946	0339947	0339948	-
16	16	24	66	125	0339949	-	0339950	0339951	0339952	0339953	0339954	-
			82	150	0856029	-	0853413	0853415	0853416	0853417	0853419	-
			62	125	0339955	-	0339956	0339957	0339958	0339959	0339960	0339961
20	20	30	82	135	0853421	-	0853422	0853426	0853428	0853431	0853432	0853433
			102	150	0339962	-	0339963	0339964	0339965	0339966	0339967	0339968

D = Tool Diameter

APC5 POW•R•PATH



For high-efficiency machining (HEM) in aluminum alloys. Adds the benefits of the unique **Chip Management System (CMS)** to the versatility of the APT5 design. Breaks up long, stringy chips, which eliminates recutting chips and chip packing, and allows for deep, free cutting tool movement in aluminum. The results are great chip control and very high metal removal rates.

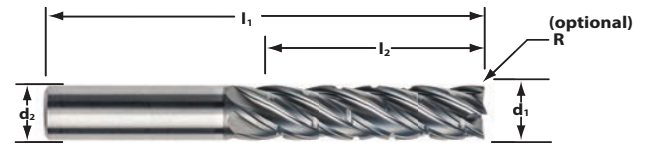

in: d1: -0.0001 / -0.0004 d2: -0.0001 / -0.0004
mm: d1: -0.0025 / -0.0100 d2: -0.0025 / -0.0100



Cutter Dia d1	Shank Dia d2	Max Axial Depth xD	Length of Cut l2	Overall Length l1	Order Code SQ	Order Code by Corner Radius	
						.015 CR	.030 CR
3/8	3/8	3	1-1/8	3	0339528	0339529	-
		4	1-1/2	3-1/2	0339530	0339531	-
1/2	1/2	2.5	1-1/4	3-1/4	0339532	-	0339533
		3	1-1/2	3-1/2	0339534	-	0339535
		3.5	1-3/4	4	0339536	-	0339537
		4	2	4	0339538	-	0339539
5/8	5/8	2	1-1/4	3-1/2	0339540	-	0339541
		3	1-7/8	4	0339542	-	0339543
		4	2-1/2	5	0339544	-	0339545
3/4	3/4	2.5	1-7/8	4-1/2	0339546	-	0339547
		3	2-1/4	5	0339548	-	0339549
		3.5	2-5/8	5	0339550	-	0339551
		4	3	6	0339552	-	0339553
1	1	2	2	5	0339554	-	0339555
		3	3	6	0339556	-	0339557
		4	4	7	0339558	-	0339559

Cutter Dia d1	Shank Dia d2	Max Axial Depth xD	Length of Cut l2	Overall Length l1	Order Code SQ	Order Code by Corner Radius	
						0.5 CR	1.0 CR
10	10	3	30	75	0339560	0339561	-
		4	40	88	0339562	0339563	-
12	12	2.5	30	83	0339564	-	0339565
		3	36	88	0339566	-	0339567
		3.5	42	93	0339568	-	0339569
		4	48	100	0339570	-	0339571
16	16	2	32	92	0339572	-	0339573
		3	48	110	0339574	-	0339575
		4	64	125	0339576	-	0339577
20	20	2	40	104	0339578	-	0339579
		2.5	50	115	0339580	-	0339581
		3	60	125	0339582	-	0339583
		3.5	70	135	0339584	-	0339585
		4	80	150	0339586	-	0339587

D = Tool Diameter

APT5/APC5 Application Guide – Speed & Feed (inch)

ISO Code	Work Material	Tool LBS/d1	Type of Cut	Axial DOC	Radial DOC	No. of Flutes	Speed (SFM)	Feed (Inch per Tooth)					
								1/4	3/8	1/2	5/8	3/4	1
N	Aluminum Alloys 6061, 7075, 2024	≤ 2	Slotting	1 x D	1 x D	5	600	.0015	.0023	.0030	.0038	.0045	.0060
		≤ 2	Peripheral - HEM	≤ 2 x D	.25 x D	5	850	.0050	.0075	.0100	.0125	.0150	.0200
		2 - 2.5	Peripheral - HEM	> 2 - 2.5 x D	.25 x D	5	800	.0050	.0075	.0100	.0125	.0150	.0200
		2.5 - 3	Peripheral - HEM	> 2.5 - 3 x D	.25 x D	5	800	.0050	.0075	.0100	.0125	.0150	.0200
		3 - 3.5	Peripheral - HEM	> 3 - 3.5 x D	.25 x D	5	800	.0048	.0071	.0095	.0119	.0143	.0190
		3.5 - 4	Peripheral - HEM	> 3.5 - 4 x D	.20 x D	5	780	.0048	.0071	.0095	.0119	.0143	.0190
		≤ 2	Peripheral - Rough	≤ 2 x D	.45 x D	5	1000	.0024	.0036	.0048	.0060	.0072	.0096
		> 2 - 3	Peripheral - Rough	> 2 - 3 x D	.375 x D	5	900	.0023	.0035	.0046	.0058	.0069	.0092
		> 3	Peripheral - Rough	> 3 - 4 x D	.35 x D	5	800	.0023	.0034	.0045	.0056	.0068	.0090
		≤ 4 x D	Finish	≤ 4 x D	.01 x D	5	650	.0015	.0023	.0030	.0038	.0045	.0060

D = Tool Diameter HEM = High-efficiency machining

APT5/APC5 Application Guide – Speed & Feed (metric)

ISO Code	Work Material	Tool LBS/d1	Type of Cut	Axial DOC	Radial DOC	Number of Flutes	Speed (M/min)	Feed (MM per Tooth)					
								6.0	8.0	10.0	12.0	16.0	20.0
N	Aluminum Alloys 6061, 7075, 2024	≤ 2	Slotting	1 x D	1 x D	5	183	.0360	.0480	.0598	.0720	.0958	.1195
		≤ 2	Peripheral - HEM	≤ 2 x D	.25 x D	5	259	.1200	.1600	.1992	.2400	.3192	.3984
		2 - 2.5	Peripheral - HEM	> 2 - 2.5 x D	.25 x D	5	244	.1200	.1600	.1992	.2400	.3192	.3984
		2.5 - 3	Peripheral - HEM	> 2.5 - 3 x D	.25 x D	5	244	.1200	.1600	.1992	.2400	.3192	.3984
		3 - 3.5	Peripheral - HEM	> 3 - 3.5 x D	.25 x D	5	244	.1140	.1520	.1892	.2280	.3032	.3784
		3.5 - 4	Peripheral - HEM	> 3.5 - 4 x D	.20 x D	5	238	.1140	.1520	.1892	.2280	.3032	.3784
		≤ 2	Peripheral - Rough	≤ 2 x D	.45 x D	5	305	.0576	.0768	.0956	.1152	.1532	.1912
		> 2 - 3	Peripheral - Rough	> 2 - 3 x D	.375 x D	5	274	.0552	.0736	.0916	.1104	.1468	.1832
		> 3	Peripheral - Rough	> 3 - 4 x D	.35 x D	5	244	.0540	.0720	.0896	.1080	.1436	.1793
		≤ 4 x D	Finish	≤ 4 x D	.01 x D	5	198	.0360	.0480	.0598	.0720	.0958	.1195

D = Tool Diameter HEM = High-efficiency machining (chip thinning calculations have already been applied to HEM parameters)

≈ Approximately Equals < Less Than
 ≤ Less Than or Equal To > Greater Than
 ≥ Greater Than or Equal To = Equals
 × Multiply

Common Machining Formulas

$$RPM = \frac{SFM \times 3.82}{D}$$

$$SFM = RPM \times D \times .262$$

$$IPM = RPM \times IPT \times Z$$

$$MRR = RDOC \times ADOC \times IPM$$

$$RPM = \frac{M/min \times 318.3}{D}$$

$$M/min = RPM \times D \times .00314$$

$$MMPM = RPM \times MMPT \times Z$$

$$MRR = RDOC \times ADOC \times MMPM$$

D Tool Diameter

Z Number of Flutes

RPM Revolutions per Minute

SFM Surface Feet per Minute

M/min Surface Meters per Minute

IPM Inches per Minute

MMPM Millimeters per Minute

IPT Inch per Tooth

MMPT Millimeters per Tooth

MRR Metal Removal Rate

RDOC Radial Depth of Cut

ADOC Axial Depth of Cut

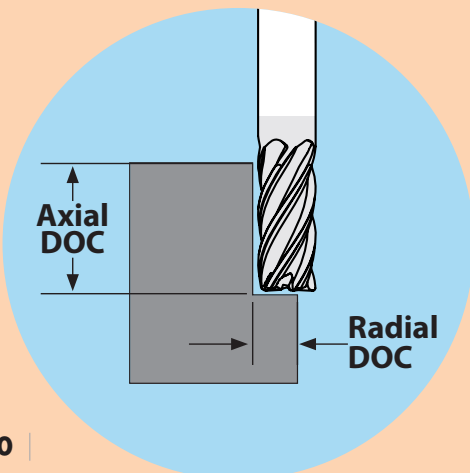

Technical Resources

Information on tips and adjustments for the following milling operations can be found in our Technical Resources section beginning on page 134.

- HEM slotting
- Face milling
- Helical entry ramping
- Straight line ramping
- Long tool projection adjustments
- Ball nose milling adjustments
- Other helpful tips and calculations



AFC5/IFC5 DEEP WALL FINISHER



Designed to address difficulties in meeting straightness and surface finish requirements in deep reach applications in aluminum (AFC5) and in steels and hi-temp alloys (IFC5). Built with the ultimate core thickness, the AFC5/IFC5 design tackles deflection issues that occur when machining deep cuts, minimizing wall taper. Combined with the unique cutting edge geometry, the AFC5/IFC5 generates superior wall and floor finishes.

AFC5

Cutter Dia d1	Shank Dia d2	Max Axial Depth xD	Length of Cut l2	Overall Length l1	Order Code by Corner Radius	
					.030 CR	.060 CR
1/2	1/2	4	2	4	0335265	-
		6	3	6	0335266	-
5/8	5/8	4	2-1/2	5	-	0335267
		6	3-3/4	6-1/2	-	0335268
3/4	3/4	4	3	6	-	0335269
		6	4-1/2	7	-	0335270
1	1	4	4	8	-	0335271
		6	6	12	-	0335272

D = Tool Diameter

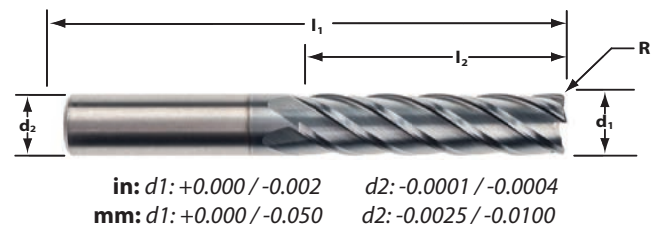

IFC5

Cutter Dia d1	Shank Dia d2	Max Axial Depth xD	Length of Cut l2	Overall Length l1	Order Code by Corner Radius	
					.030 CR	.060 CR
1/2	1/2	4	2	4	0335273	-
		6	3	6	0335274	-
5/8	5/8	4	2-1/2	5	-	0335275
		6	3-3/4	6-1/2	-	0335276
3/4	3/4	4	3	6	-	0335277
		6	4-1/2	7	-	0335278
1	1	4	4	8	-	0335279
		6	6	12	-	0335280

D = Tool Diameter

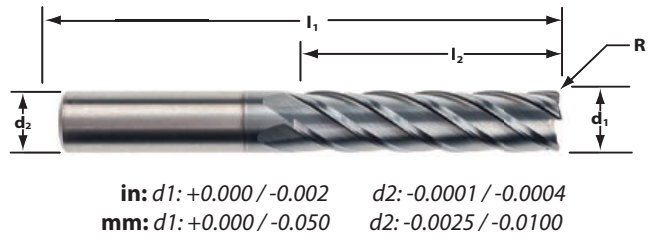

Standard dimensions are shown above, but IMCO recognizes that all machine parts are unique so they require unique tools to finish mill. Variations of the AFC and IFC end mills with different flute lengths and overall lengths are possible. Contact IMCO for quotations with the specifications needed to finish your application at 1-800-765-4626.



FINISHER ONLY

AFC5/IFC5 Application Guide – Speed & Feed (inch)

AFC5 Application Guide – Speed & Feed (inch)

ISO Code	Work Material	Type of Cut	Tool LC/Dia.	Axial DOC	Radial DOC	No. of Flutes	Speed (SFM)	Feed (Inch per Tooth)			
								1/2	5/8	3/4	1
N	Aluminum Alloys 6061, 7075, 2024	Peripheral - Finish	3 - 4	4 x D	.01 x D	5	425	.0021	.0026	.0032	.0042
		Peripheral - Finish	< 4 - 6	6 x D	.01 x D	5	350	.0017	.0022	.0026	.0035

D = Tool Diameter

IFC5 Application Guide – Speed & Feed (inch)

ISO Code	Work Material	Type of Cut	Tool LC/Dia.	Axial DOC	Radial DOC	No. of Flutes	Speed (SFM)	Feed (Inch per Tooth)				
								1/2	5/8	3/4	1	
K	Cast Iron - Gray ASTM - A48, Class 20, 25, 30, 35 & 40	Peripheral - Finish	3 - 4	4 x D	.01 x D	5	290	.0017	.0021	.0026	.0034	
		Peripheral - Finish	< 4 - 6	6 x D	.01 x D	5	235	.0014	.0017	.0021	.0028	
	Cast Iron - Malleable	Peripheral - Finish	3 - 4	4 x D	.01 x D	5	275	.0017	.0021	.0026	.0034	
		Peripheral - Finish	< 4 - 6	6 x D	.01 x D	5	220	.0014	.0017	.0020	.0027	
P	Low Carbon Steel ≤ 38 HRc 1018, 1020, 12L14, 5120, 8620	Peripheral - Finish	3 - 4	4 x D	.01 x D	5	300	.0018	.0023	.0027	.0036	
		Peripheral - Finish	< 4 - 6	6 x D	.01 x D	5	240	.0014	.0018	.0022	.0029	
	Medium Carbon Steel ≤ 48 HRc 1045, 4140, 4340, 5140	Peripheral - Finish	3 - 4	4 x D	.01 x D	5	290	.0017	.0021	.0026	.0034	
		Peripheral - Finish	< 4 - 6	6 x D	.01 x D	5	235	.0014	.0017	.0021	.0028	
	Tool & Die Steels ≤ 40 HRc A2, D2, O1, S7, P20, H13	Peripheral - Finish	3 - 4	4 x D	.01 x D	5	275	.0016	.0020	.0024	.0032	
		Peripheral - Finish	< 4 - 6	6 x D	.01 x D	5	220	.0013	.0016	.0019	.0026	
M	Martensitic & Ferritic Stainless Steels 410, 416, 440	Peripheral - Finish	3 - 4	4 x D	.01 x D	5	280	.0017	.0021	.0026	.0034	
		Peripheral - Finish	< 4 - 6	6 x D	.01 x D	5	227	.0014	.0017	.0021	.0028	
	Austenitic Stainless Steels 303, 304, 316, Invar, Kovar	Peripheral - Finish	3 - 4	4 x D	.01 x D	5	275	.0016	.0020	.0024	.0032	
		Peripheral - Finish	< 4 - 6	6 x D	.01 x D	5	220	.0013	.0016	.0019	.0026	
	Precipitation Hardening Stainless Steel 17-4, 15-5, 13-8	Peripheral - Finish	3 - 4	4 x D	.01 x D	5	255	.0015	.0019	.0023	.0030	
		Peripheral - Finish	< 4 - 6	6 x D	.01 x D	5	204	.0012	.0015	.0018	.0024	
	S	Titanium Alloys 6AL-4V, 6-2-4	Peripheral - Finish	3 - 4	4 x D	.01 x D	5	320	.0018	.0023	.0027	.0036
			Peripheral - Finish	< 4 - 6	6 x D	.01 x D	5	256	.0014	.0018	.0022	.0029

D = Tool Diameter

Information on tips and adjustments can be found in our Technical Resources section beginning on page 134.

≈	Approximately Equals	<	Less Than
≤	Less Than or Equal To	>	Greater Than
≥	Greater Than or Equal To	=	Equals
x	Multiply		

TOOL TIP

AFC5/IFC5



- **BIG CORE.**
- **LITTLE DEFLECTION.**
- **MINIMAL WALL TAPER IN DEEP REACH APPLICATIONS.**

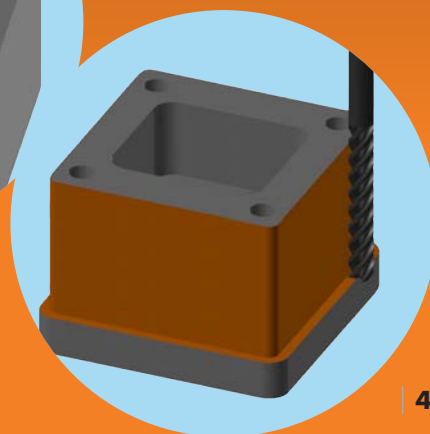
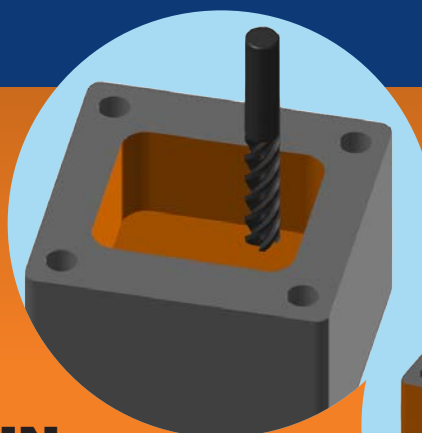

The logo for enDURO, with 'en' in lowercase and 'DURO' in uppercase, followed by a registered trademark symbol. The text is in a bold, sans-serif font.

MUSCLE TO HUSTLE IN TITANIUM AND STAINLESS STEELS

Advanced high-shear cutting edges and amazing corner strength make enDURO end mills the best choice for milling hard-to-machine materials, whether you use high-efficiency machining or traditional techniques.



M5 Series Features

MUSCLE TO HUSTLE.

Truly a “go-to” tool for a wide range of applications, enDURO end mills are the ultimate combination of strength and flexibility. A solid core, reinforced cutting edges, variable indexed flutes and an advanced coating all come together in the M525 and M527 series to create an “everyday” high-performance end mill that excels in both traditional and high-efficiency milling tool paths.



	M525	M525C	M525N	M527	M527N	M527C	M503
NUMBER OF FLUTES	Z5	Z5	Z5	Z7	Z7	Z7	Z3
END TYPES	SQ	SQ	SQ	SQ	CR	SQ	SQ
	CR	CR	CR	CR		CR	CR
	BN		BN				
HELIX ANGLE	40°	40°	40°	40°	40°	40°	40°
COATING	AlCrNX	AlCrNX	AlCrNX	AlCrNX	AlCrNX	AlCrNX	AlTiN
SHANK TYPES	PLAIN	PLAIN	PLAIN	PLAIN	PLAIN	PLAIN	PLAIN
			NECK		NECK		
APPLICATIONS	HEM	HEM	ROUGH	HEM	HEM	HEM	ROUGH
	ROUGH	ROUGH	FINISH	ROUGH	ROUGH	ROUGH	FINISH
	FINISH			FINISH	FINISH		
MATERIAL(S)							

M525 enDURO



For high-performance machining in materials ranging from low carbon steels to titanium. Engineered for both speed and tool life, the M525 series is extremely versatile. It optimizes tool performance in many materials and in many application environments, from short runs in job shops to long production runs.

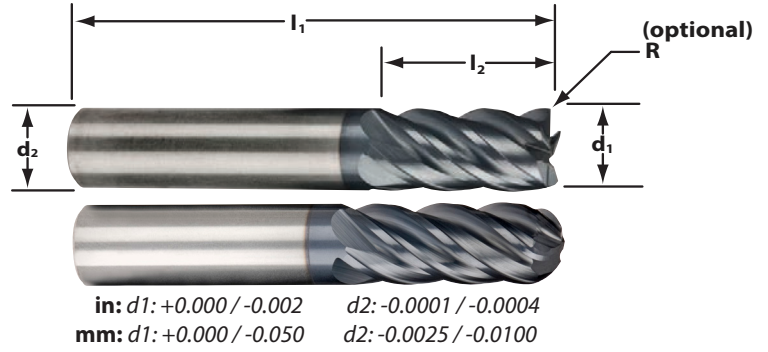

Cutter Dia d1	Shank Dia d2	Length of Cut L2	Overall Length L1	Order Code SQ	Order Code by Corner Radius							Order Code BN
					.015 CR	.030 CR	.060 CR	.090 CR	.120 CR	.190 CR	.250 CR	
1/8	1/8	1/4	1-1/2	0335808	0335809	0335810	-	-	-	-	-	0335811
		1/2	1-1/2	0335812	0335813	0335814	-	-	-	-	-	0335815
		3/4	2-1/2	0335816	0335817	0335818	-	-	-	-	-	0335819
3/16	3/16	5/16	2	0335820	0335821	0335822	-	-	-	-	-	0335823
		9/16	2	0335824	0335825	0335826	-	-	-	-	-	0335827
		3/4	2-1/2	0335828	0335829	0335830	-	-	-	-	-	0335831
1/4	1/4	3/8	2	0335832	0335833	0335834	0335835	0335836	-	-	-	0335837
		3/4	2-1/2	0335856	0335857	0335858	0335859	0335860	-	-	-	0335861
		1-1/8	3	0335862	0335863	0335864	0335865	0335866	-	-	-	0335867
5/16	5/16	7/16	2	0335868	0335869	0335870	0335871	0335872	-	-	-	0335873
		13/16	2-1/2	0335874	0335875	0335876	0335877	0335878	-	-	-	0335879
		1-1/4	3	0335880	0335881	0335882	0335883	0335884	-	-	-	0335885
		2-1/8	4	0335886	0335887	0335888	0335889	0335890	-	-	-	0335891
3/8	3/8	1/2	2	0335892	0335893	0335894	0335895	0335896	0335897	-	-	0335899
		1	2-1/2	0335940	0335941	0335942	0335943	0335944	0335945	-	-	0335947
		1-1/4	3	0335948	0335949	0335950	0335951	0335952	0335953	-	-	0335955
		1-5/8	3-1/2	0335956	0335957	0335958	0335959	0335960	0335961	-	-	0335963
		1-5/8	4	0335964	0335965	0335966	0335967	0335968	0335969	-	-	0335971
		2	4	0335980	0335981	0335982	0335983	0335984	0335985	-	-	0335987
7/16	7/16	5/8	2-1/2	0335996	0335997	0335998	-	-	-	-	-	0336003
		1	2-3/4	0336004	0336005	0336006	-	-	-	-	-	0336011
		2	4	0336012	0336013	0336014	-	-	-	-	-	0336019
1/2	1/2	5/8	2-1/2	0336020	0336021	0336022	0336023	0336024	0336025	-	-	0336028
		1	3	0336065	0336066	0336067	0336068	0336069	0336070	-	-	0336073
		1-1/4	3	0336074	0336075	0336076	0336077	0336078	0336079	0336081	-	0336082
		1-5/8	4	0336083	0336084	0336085	0336086	0336087	0336088	-	-	0336091
		1-5/8	6	0336092	0336093	0336094	0336095	0336096	0336097	-	-	0336100
		2-1/8	4	0336101	0336102	0336103	0336104	0336105	0336106	0336108	-	0336109
		2-5/8	5	0336110	0336111	0336112	0336113	0336114	0336115	-	-	0336118
		3-1/4	6	0336119	0336120	0336121	0336122	0336123	0336124	-	-	0336127
5/8	5/8	3/4	3	0336128	0336129	0336130	0336131	-	0336133	-	-	0336137
		1-5/8	3-1/2	0336168	0336169	0336170	0336171	0336172	0336173	0336175	-	0336177
		2-1/8	4	0336178	0336179	0336180	0336181	-	0336183	-	-	0336187
		2-1/8	6	0336188	0336189	0336190	0336191	-	0336193	-	-	0336197
		2-5/8	5	0336198	0336199	0336200	0336201	0336202	0336203	0336205	-	0336207
		3-1/4	6	0336208	0336209	0336210	0336211	-	0336213	-	-	0336217
		4	6	0336218	0336219	0336220	0336221	-	0336223	-	-	0336227
3/4	3/4	1	3	0336228	0336229	0336230	0336231	-	0336233	-	0336236	0336237
		1-5/8	4	0336268	0336269	0336270	0336271	0336272	0336273	0336275	0336276	0336277
		2-3/8	5	0336278	0336279	0336280	0336281	0336282	0336283	0336285	0336286	0336287
		2-3/8	6	0336288	0336289	0336290	0336291	-	0336293	-	0336296	0336297
		3-1/4	6	0336298	0336299	0336300	0336301	-	0336303	-	0336306	0336307
		4-1/8	7	0336308	0336309	0336310	0336311	-	0336313	-	0336316	0336317
1	1	1-3/4	4	0336362	0336363	0336364	0336365	0336366	0336367	0336369	0336370	0336372
		2-5/8	5	0336373	0336374	0336375	0336376	0336377	0336378	0336380	0336381	0336383
		3-1/4	6	0336384	0336385	0336386	0336387	-	0336389	-	0336392	0336394
		4-1/4	7	0336395	0336396	0336397	0336398	-	0336400	-	0336403	0336405

Cutter Dia d1	Shank Dia d2	Length of Cut l2	Overall Length l1	Order Code SQ	Order Code by Corner Radius								
					0.5 CR	0.75 CR	1.0 CR	1.5 CR	2.0 CR	3.0 CR	4.0 CR	5.0 CR	
6	6	10	54	-	0337088	-	-	-	-	-	-	-	-
		13	57	0336918	0336919	-	0336921	0336922	-	-	-	-	-
		25	75	0337089	0337091	-	0337092	-	-	-	-	-	-
8	8	12	58	-	0337093	-	-	-	-	-	-	-	-
		19	63	0336923	0336924	-	0336926	0336927	-	-	-	-	-
		32	75	0337094	0337095	-	0337096	-	-	-	-	-	-
10	10	14	66	-	-	-	0337097	-	-	-	-	-	-
		22	72	0336928	0336929	-	0336931	0336932	0336933	-	-	-	-
		40	88	0337099	0337100	-	0337101	0337102	0337103	-	-	-	-
12	12	16	73	-	-	-	0337104	-	-	-	-	-	-
		26	83	0336934	0336935	0336936	0336937	0336938	0336939	0336940	-	-	-
		50	100	0337122	-	0337123	0337124	0337125	0337106	0337107	-	-	-
		75	150	0337126	-	0337127	0337128	0337129	-	-	-	-	-
16	16	22	82	-	-	-	0337108	-	-	-	-	-	-
		32	92	0336941	-	0336942	0336943	0336944	0336945	0336946	0336947	-	-
		55	110	0337130	-	0337131	0337132	0337133	0337109	0337110	-	-	-
		75	150	0337134	-	0337135	0337136	0337137	-	-	-	-	-
20	20	26	92	-	-	-	0337111	-	-	-	-	-	-
		38	104	0336948	-	-	0336950	0336951	0336952	0336953	0336954	0336955	-
		65	125	0337138	-	-	0337140	0337141	0337112	0337114	-	-	-
		85	150	0337142	-	-	0337144	0337145	0337115	0337116	-	-	-
25	25	45	120	0336956	-	-	0336958	0336959	0336960	0336961	0336962	0336963	-
		85	150	0337146	-	-	0337148	0337149	0337117	0337118	0337119	-	-



TOOL TIP

How Do You Spell Versatility? "e-n-D-U-R-O."

The M5 enDURO series of end mills are the definition of versatility. The 5- and 7-flute designs are made to rough and finish in traditional tool paths and in high-efficiency machining techniques. From job shops to high-production environments, the M5 is the "go-to" tool that saves you time and money.

- Many corner radius options.
- Optional necked shanks for pocket milling.
- Chip Management System (CMS) to stop chip pollution for free cutting machining.
- Advanced grinds and coatings to machine carbon steels, stainless steels, titanium and hi-temp alloys.



M525C enDURO



For high-performance machining in materials ranging from low carbon steels to titanium. Adds the benefits of the unique **Chip Management System (CMS)** to the versatility of the M525 design. Breaks up long, stringy chips, which eliminates recutting chips and chip packing, and allows for free cutting tool movement in a variety of materials.

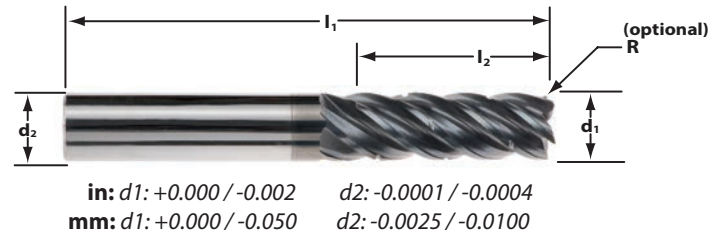

Cutter Dia d1	Shank Dia d2	Length of Cut I2	Overall Length I1	Order Code SQ	Order Code by Corner Radius			
					.015 CR	.030 CR	.060 CR	.120 CR
1/2	1/2	2-1/8	4	0337309	0337310	0337311	0337312	-
		2-5/8	5	0337314	0337315	0337316	0337317	-
		3-1/4	6	0337319	0337320	0337321	0337322	-
5/8	5/8	2-1/8	4	0337324	-	0337326	0337327	-
		2-5/8	5	0337329	-	0337331	0337332	-
		3-1/4	6	0337334	-	0337336	0337337	-
3/4	3/4	2-3/8	5	0337339	-	0337341	-	0337343
		3-1/4	6	0337344	-	0337346	-	0337348
		4-1/8	7	0337349	-	0337351	-	0337353
1	1	2-5/8	5	0337354	-	0337356	-	0337358
		3-1/4	6	0337359	-	0337361	-	0337363
		4-1/4	7	0337364	-	0337366	-	0337368

Cutter Dia d1	Shank Dia d2	Length of Cut I2	Overall Length I1	Order Code SQ	Order Code by Corner Radius		
					0.75 CR	1.0 CR	1.5 CR
12	12	50	100	0337150	0337151	0337152	0337153
		75	150	0337154	0337155	0337156	0337157
16	16	55	110	0337158	0337159	0337160	0337161
		75	150	0337162	0337163	0337164	0337165
20	20	65	125	0337166	-	0337168	0337169
		85	150	0337170	-	0337172	0337173
25	25	55	120	0337174	-	0337176	0337177
		85	150	0337178	-	0337180	0337181

M525N enDURO



For high-performance machining in materials ranging from low carbon steels to titanium. Adding a necked shank to the M525 design offers a high-performance tool that permits clearance in deeper cavities and easier machining against tight walls. Neck relief and short flute length combine to increase end mill stability in the cut for more precise tolerances. Great for work in pockets.

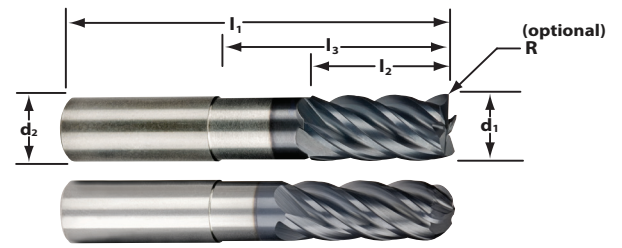

in: d1: +0.000 / -0.002 d2: -0.0001 / -0.0004
mm: d1: +0.000 / -0.050 d2: -0.0025 / -0.0100



Cutter Dia d1	Shank Dia d2	Length of Cut L2	Reach LBS L3	Overall Length L1	Order Code SQ	Order Code by Corner Radius					Order Code BN
						.015 CR	.030 CR	.060 CR	.120 CR	.250 CR	
1/4	1/4	3/8	1-1/8	2-1/2	0336472	0336474	0336476	0336478	-	-	0336482
			1-3/8	3	0336484	0336486	0336488	0336490	-	-	0336494
			2-3/8	4	0336496	0336498	0336500	0336502	-	-	0336506
3/8	3/8	1/2	1-3/8	3	0336508	0336510	0336512	0336514	-	-	0336522
			2-3/8	4	0336524	0336526	0336528	0336530	-	-	0336538
			3-3/8	5	0336540	0336542	0336544	0336546	-	-	0336554
1/2	1/2	5/8	1-3/8	3	0336572	0336574	0336576	0336578	0336582	-	0336588
			2-1/4	4	0336590	0336592	0336594	0336596	0336600	-	0336606
			3-1/4	5	0336608	0336610	0336612	0336614	0336618	-	0336624
			4-1/4	6	0336626	0336628	0336630	0336632	0336636	-	0336642
5/8	5/8	3/4	2-1/8	4	0336644	-	0336648	0336650	0336654	-	0336662
			3-1/8	5	0336664	-	0336668	0336670	0336674	-	0336682
			4-1/8	6	0336684	-	0336688	0336690	0336694	-	0336702
3/4	3/4	1	2	4	0336704	-	0336708	0336710	0336714	0336720	0336722
			2-7/8	5	0336724	-	0336728	0336730	0336734	0336740	0336742
			3-7/8	6	0336744	-	0336748	0336750	0336754	0336760	0336762
			4-7/8	7	0337276	-	0337280	0337282	0337286	0337292	0337294
1	1	1-1/4	2-5/8	5	0336786	-	0336790	0336792	0336796	0336802	-
			3-5/8	6	0336808	-	0336812	0336814	0336818	0336824	-
			4-5/8	7	0336830	-	0336834	0336836	0336840	0336846	-

Cutter Dia d1	Shank Dia d2	Length of Cut L2	Reach LBS L3	Overall Length L1	Order Code SQ	Order Code by Corner Radius					Order Code BN
						0.5 CR	1.0 CR	1.5 CR	2.0 CR	3.0 CR	
6	6	8	27	63	0336964	0337098	0337105	0337113	-	-	0337065
			39	75	0336969	0337120	0337121	0336965	-	-	0337067
			64	100	0336974	0336966	0336967	0336968	-	-	0337068
8	8	10	27	63	0336979	0336970	0336971	0336972	-	-	0337069
			39	75	0336984	0336973	0336975	0336976	-	-	0337070
			64	100	0336990	0336977	0336978	0336980	-	-	0337071
10	10	12	32	72	0336996	0336981	0336982	0336983	-	-	0337072
			60	100	0337003	0336986	0336987	0336988	-	-	0337073
			38	83	0337017	0336995	0336997	0336998	0336999	0337000	0337076
12	12	15	55	100	0337024	0337001	0337002	0337004	0337005	0337006	0337077
			80	125	0337031	0337007	0337008	0337009	0337011	0337012	0337078
			105	150	0337038	0337013	0337014	0337015	0337016	0337018	0337079
16	16	20	62	110	0337045	-	0337019	0337020	0337021	0337022	0337080
			102	150	0337052	-	0337025	0337026	0337027	0337028	0337081
20	20	25	75	125	0337066	-	0337037	0337039	0337040	0337041	0337084
			100	150	0337074	-	0337044	0337046	0337047	0337048	0337085
25	25	32	64	120	0337082	-	0337051	0337053	0337054	0337055	-
			94	150	0337090	-	0337058	0337060	0337061	0337062	-

M525 Application Guide – Speed & Feed (inch)

ISO Code	Work Material	Type of Cut	Axial DOC	Radial DOC	No. of Flutes	Speed (SFM)	Feed (Inches per Tooth)									
							1/8	3/16	1/4	5/16	3/8	7/16	1/2	5/8	3/4	1
K	Cast Iron Gray ASTM-A48 Class 20, 25, 30, 35 & 40	Slotting	.5 x D	1 x D	5	300	.0006	.0009	.0012	.0015	.0018	.0021	.0024	.0030	.0036	.0048
		Peripheral - Rough	1.25 x D	.3 x D	5	375	.0008	.0012	.0016	.0020	.0025	.0029	.0033	.0041	.0049	.0065
		Finish	2 x D	.015 x D	5	375	.0008	.0012	.0017	.0021	.0025	.0029	.0033	.0042	.0050	.0067
	Cast Iron Malleable	Slotting	.5 x D	1 x D	5	275	.0005	.0008	.0010	.0013	.0015	.0018	.0020	.0025	.0030	.0040
		Peripheral - Rough	1.25 x D	.3 x D	5	350	.0007	.0010	.0014	.0017	.0020	.0024	.0027	.0034	.0041	.0055
		Peripheral - HEM*	3 x D	.05 x D	5	390	.0020	.0030	.0040	.0050	.0060	.0070	.0081	.0101	.0121	.0161
P	Low Carbon Steels ≤ 38 Rc 1018, 1020, 12L14, 5120, 8620	Slotting	.5 x D	1 x D	5	325	.0007	.0011	.0014	.0018	.0021	.0025	.0028	.0035	.0042	.0056
		Peripheral - Rough	1.25 x D	.3 x D	5	400	.0010	.0014	.0019	.0024	.0029	.0033	.0038	.0048	.0057	.0076
		Peripheral - HEM*	3 x D	.07 x D	5	450	.0028	.0042	.0056	.0070	.0084	.0098	.0112	.0140	.0168	.0224
		Finish	2 x D	.015 x D	5	400	.0010	.0015	.0019	.0024	.0029	.0034	.0039	.0049	.0058	.0078
		Slotting	.5 x D	1 x D	5	300	.0006	.0010	.0013	.0016	.0019	.0022	.0026	.0032	.0038	.0051
		Peripheral - Rough	1.25 x D	.3 x D	5	375	.0009	.0013	.0017	.0022	.0026	.0031	.0035	.0044	.0052	.0070
	Medium Carbon Steels ≤ 48 HRC 1045, 4140, 4340, 5140	Peripheral - HEM*	3 x D	.05 x D	5	415	.0026	.0039	.0052	.0065	.0077	.0090	.0103	.0129	.0155	.0207
		Finish	2 x D	.015 x D	5	375	.0009	.0013	.0018	.0022	.0027	.0031	.0036	.0044	.0053	.0071
		Slotting	.5 x D	1 x D	5	275	.0005	.0008	.0011	.0014	.0016	.0019	.0022	.0027	.0032	.0043
		Peripheral - Rough	1.25 x D	.3 x D	5	350	.0007	.0011	.0015	.0018	.0022	.0026	.0029	.0037	.0044	.0059
		Peripheral - HEM*	3 x D	.05 x D	5	390	.0022	.0032	.0043	.0054	.0065	.0076	.0087	.0108	.0130	.0173
		Finish	2 x D	.015 x D	5	350	.0007	.0011	.0015	.0019	.0022	.0026	.0030	.0037	.0045	.0060
M	Martensitic & Ferritic Stainless Steels 410, 416, 440	Slotting	.5 x D	1 x D	5	300	.0006	.0010	.0013	.0016	.0019	.0022	.0026	.0032	.0038	.0051
		Peripheral - Rough	1.25 x D	.3 x D	5	375	.0009	.0013	.0017	.0022	.0026	.0031	.0035	.0044	.0052	.0070
		Peripheral - HEM*	3 x D	.05 x D	5	415	.0026	.0039	.0052	.0065	.0077	.0090	.0103	.0129	.0155	.0207
		Finish	2 x D	.015 x D	5	375	.0009	.0013	.0018	.0022	.0027	.0031	.0036	.0044	.0053	.0071
		Slotting	.5 x D	1 x D	5	275	.0006	.0009	.0012	.0015	.0018	.0021	.0024	.0030	.0036	.0048
		Peripheral - Rough	1.25 x D	.3 x D	5	350	.0008	.0012	.0016	.0020	.0025	.0029	.0033	.0041	.0049	.0065
	Austenitic Stainless Steels, FeNi Alloys 303, 304, 316, Invar, Kovar	Peripheral - HEM*	3 x D	.05 x D	5	390	.0025	.0037	.0049	.0062	.0074	.0086	.0099	.0123	.0148	.0198
		Finish	2 x D	.015 x D	5	350	.0008	.0012	.0017	.0021	.0025	.0029	.0033	.0042	.0050	.0067
		Slotting	.5 x D	1 x D	5	250	.0005	.0008	.0010	.0013	.0015	.0018	.0020	.0025	.0030	.0040
		Peripheral - Rough	1.25 x D	.3 x D	5	325	.0007	.0010	.0014	.0017	.0020	.0024	.0027	.0034	.0041	.0055
		Peripheral - HEM*	3 x D	.05 x D	5	360	.0020	.0030	.0040	.0049	.0059	.0069	.0079	.0099	.0119	.0158
		Finish	1.5 x D	.015 x D	5	325	.0007	.0010	.0014	.0017	.0021	.0024	.0028	.0035	.0042	.0056
S	Titanium Alloys 6Al-4V, 6-2-4	Slotting	.5 x D	1 x D	5	250	.0005	.0007	.0009	.0012	.0014	.0016	.0018	.0023	.0028	.0037
		Peripheral - Rough	1 x D	.3 x D	5	300	.0006	.0009	.0013	.0016	.0019	.0022	.0025	.0031	.0038	.0050
		Peripheral - HEM*	3 x D	.05 x D	5	330	.0018	.0027	.0036	.0046	.0055	.0064	.0073	.0091	.0109	.0146
		Finish	1.5 x D	.015 x D	5	300	.0006	.0010	.0013	.0016	.0019	.0022	.0026	.0032	.0038	.0051
		Slotting	.25 x D	1 x D	5	200	.0003	.0005	.0007	.0009	.0010	.0012	.0014	.0017	.0020	.0027
		Peripheral - Rough	1 x D	.25 x D	5	250	.0005	.0007	.0010	.0012	.0015	.0017	.0020	.0025	.0029	.0039
	Difficult-to-Machine Titanium Alloys 10-2-3 Precipitation Hardening Stainless Steels M 13-8	Peripheral - HEM*	3 x D	.05 x D	5	275	.0015	.0022	.0030	.0037	.0045	.0052	.0059	.0074	.0089	.0119
		Finish	1.5 x D	.01 x D	5	250	.0006	.0009	.0012	.0014	.0017	.0020	.0023	.0029	.0035	.0046

D = Tool Diameter *HEM = High-efficiency machining (chip thinning calculations have already been applied to HEM parameters shown).

≈ Approximately Equals < Less Than
 ≤ Less Than or Equal To > Greater Than
 ≥ Greater Than or Equal To = Equals
 × Multiply

Common Machining Formulas

$$RPM = \frac{SFM \times 3.82}{D}$$

$$SFM = RPM \times D \times .262$$

$$IPM = RPM \times IPT \times Z$$

$$MRR = RDOC \times ADOC \times IPM$$

$$RPM = \frac{M/min \times 318.3}{D}$$

$$M/min = RPM \times D \times .00314$$

$$MMPM = RPM \times MMPT \times Z$$

$$MRR = RDOC \times ADOC \times MMPM$$

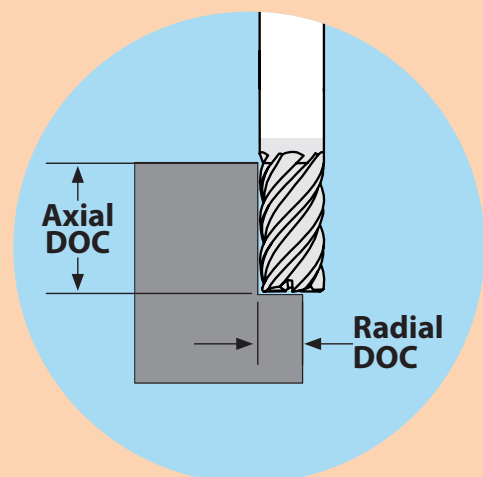

M525 Application Guide – Speed & Feed (metric)

ISO Code	Work Material	Type of Cut	Axial DOC	Radial DOC	No. of Flutes	Speed (M/min)	Feed (MM per Tooth)						
							6.0	8.0	10.0	12.0	16.0	20.0	25.0
K	Cast Iron Gray ASTM-A48 Class 20, 25, 30, 35 & 40	Slotting	.5 x D	1 x D	5	91	.0288	.0384	.0478	.0576	.0766	.0956	.1200
		Peripheral - Rough	1.25 x D	.3 x D	5	114	.0393	.0524	.0652	.0786	.1045	.1304	.1636
		Finish	2 x D	.015 x D	5	114	.0400	.0533	.0664	.0800	.1063	.1327	.1666
	Cast Iron Malleable	Slotting	.5 x D	1 x D	5	84	.0240	.0320	.0398	.0480	.0638	.0797	.1000
		Peripheral - Rough	1.25 x D	.3 x D	5	107	.0327	.0436	.0543	.0655	.0871	.1087	.1364
		Peripheral - HEM*	3 x D	.05 x D	5	119	.0966	.1288	.1604	.1932	.2570	.3207	.4025
	Finish	2 x D	.015 x D	5	107	.0333	.0444	.0553	.0666	.0886	.1106	.1388	
P	Low Carbon Steels ≤ 38 Rc 1018, 1020, 12L14, 5120, 8620	Slotting	.5 x D	1 x D	5	99	.0336	.0448	.0558	.0672	.0894	.1115	.1400
		Peripheral - Rough	1.25 x D	.3 x D	5	122	.0458	.0611	.0761	.0916	.1219	.1521	.1909
		Peripheral - HEM*	3 x D	.07 x D	5	137	.1344	.1792	.2231	.2688	.3575	.4463	.5601
		Finish	2 x D	.015 x D	5	122	.0466	.0622	.0774	.0933	.1241	.1549	.1943
	Medium Carbon Steels ≤ 48 HRC 1045, 4140, 4340, 5140	Slotting	.5 x D	1 x D	5	91	.0307	.0410	.0510	.0614	.0817	.1020	.1280
		Peripheral - Rough	1.25 x D	.3 x D	5	114	.0419	.0559	.0695	.0838	.1114	.1391	.1746
		Peripheral - HEM*	3 x D	.05 x D	5	126	.1239	.1652	.2057	.2478	.3296	.4114	.5163
		Finish	2 x D	.015 x D	5	114	.0426	.0569	.0708	.0853	.1134	.1416	.1777
	Tool and Die Steels ≤ 48 Rc A2, D2, O1, S7, P20, H13	Slotting	.5 x D	1 x D	5	84	.0259	.0346	.0430	.0518	.0689	.0860	.1080
		Peripheral - Rough	1.25 x D	.3 x D	5	107	.0353	.0471	.0587	.0707	.0940	.1174	.1473
		Peripheral - HEM*	3 x D	.05 x D	5	119	.1040	.1386	.1726	.2079	.2765	.3452	.4332
		Finish	2 x D	.015 x D	5	107	.0360	.0480	.0597	.0720	.0957	.1195	.1499
M	Martensitic & Ferritic Stainless Steels 410, 416, 440	Slotting	.5 x D	1 x D	5	91	.0307	.0410	.0510	.0614	.0817	.1020	.1280
		Peripheral - Rough	1.25 x D	.3 x D	5	114	.0419	.0559	.0695	.0838	.1114	.1391	.1746
		Peripheral - HEM*	3 x D	.05 x D	5	126	.1239	.1652	.2057	.2478	.3296	.4114	.5163
		Finish	2 x D	.015 x D	5	114	.0426	.0569	.0708	.0853	.1134	.1416	.1777
	Austenitic Stainless Steels, FeNi Alloys 303, 304, 316, Invar, Kovar	Slotting	.5 x D	1 x D	5	84	.0288	.0384	.0478	.0576	.0766	.0956	.1200
		Peripheral - Rough	1.25 x D	.3 x D	5	107	.0393	.0524	.0652	.0786	.1045	.1304	.1636
		Peripheral - HEM*	3 x D	.05 x D	5	119	.1185	.1580	.1967	.2370	.3152	.3934	.4937
		Finish	2 x D	.015 x D	5	107	.0400	.0533	.0664	.0800	.1063	.1327	.1666
	Precipitation Hardening Stainless Steels 17-4, 15-5	Slotting	.5 x D	1 x D	5	76	.0240	.0320	.0398	.0480	.0638	.0797	.1000
		Peripheral - Rough	1.25 x D	.3 x D	5	99	.0327	.0436	.0543	.0655	.0871	.1087	.1364
		Peripheral - HEM*	3 x D	.05 x D	5	110	.0950	.1267	.1577	.1900	.2527	.3154	.3958
		Finish	1.5 x D	.015 x D	5	99	.0333	.0444	.0553	.0666	.0886	.1106	.1388
S	Titanium Alloys 6Al-4V, 6-2-4	Slotting	.5 x D	1 x D	5	76	.0221	.0294	.0366	.0442	.0587	.0733	.0920
		Peripheral - Rough	1 x D	.3 x D	5	91	.0301	.0401	.0500	.0602	.0801	.1000	.1255
		Peripheral - HEM*	3 x D	.05 x D	5	101	.0875	.1167	.1452	.1750	.2327	.2905	.3646
		Finish	1.5 x D	.015 x D	5	91	.0307	.0409	.0509	.0613	.0815	.1018	.1277
	Difficult-to-Machine Titanium Alloys 10-2-3 Precipitation Hardening Stainless Steels M 13-8	Slotting	.25 x D	1 x D	5	61	.0163	.0218	.0271	.0326	.0434	.0542	.0680
		Peripheral - Rough	1 x D	.25 x D	5	76	.0236	.0314	.0391	.0471	.0627	.0782	.0981
		Peripheral - HEM*	3 x D	.05 x D	5	84	.0712	.0950	.1183	.1425	.1895	.2365	.2968
		Finish	1.5 x D	.01 x D	5	76	.0277	.0369	.0459	.0554	.0736	.0919	.1153

D = Tool Diameter *HEM = High-efficiency machining (chip thinning calculations have already been applied to HEM parameters shown).

- D** Tool Diameter
- Z** Number of Flutes
- RPM** Revolutions per Minute
- SFM** Surface Feet per Minute
- M/min** Surface Meters per Minute
- IPM** Inches per Minute
- MMPM** Millimeters per Minute
- IPT** Inch per Tooth
- MMPT** Millimeters per Tooth
- MRR** Metal Removal Rate
- RDOC** Radial Depth of Cut
- ADOC** Axial Depth of Cut

Technical Resources

Information on tips and adjustments for the following milling operations can be found in our Technical Resources section beginning on page 134.

- HEM slotting
- Face milling
- Helical entry ramping
- Straight line ramping
- Long tool projection adjustments
- Ball nose milling adjustments
- Other helpful tips and calculations

M527 enDURO

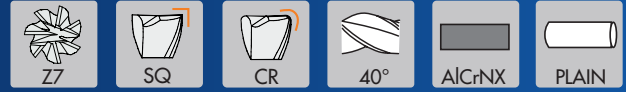

For high-performance machining in materials ranging from low carbon steels to titanium. The M527 takes the best features of the M525 and adds two cutting edges to improve metal removal rates – especially in HEM tool paths – without losing any versatility. The 7 cutting edges also make the M527 an excellent choice for finishing applications.

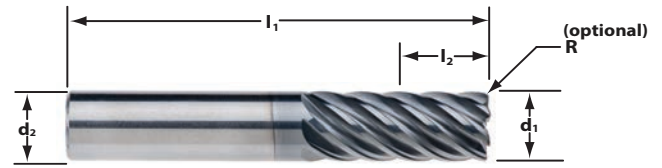

in: d1: +0.000 / -0.002 d2: -0.0001 / -0.0004
mm: d1: +0.000 / -0.050 d2: -0.0025 / -0.0100



Cutter Dia d1	Shank Dia d2	Length of Cut l2	Overall Length l1	Order Code SQ	Order Code by Corner Radius			
					.015 CR	.030 CR	.060 CR	.125 CR
3/8	3/8	1/2	2	0339048	0339049	0339050	0339051	-
		7/8	2-1/2	0339054	0339055	0339056	0339057	-
		1-1/4	3	0339060	0339061	0339062	0339063	-
1/2	1/2	5/8	2-1/2	0339066	0339067	0339068	0339069	0339071
		1-1/4	3	0339072	0339073	0339074	0339075	0339077
		1-5/8	3-1/2	0339078	0339079	0339080	0339081	0339083
		2-1/8	4	0339084	0339085	0339086	0339087	0339089
		2-5/8	5	0339090	0339091	0339092	0339093	0339095
5/8	5/8	3/4	3	0339096	-	0339098	0339099	0339101
		1-3/8	3-1/2	0339102	-	0339104	0339105	0339107
		2-1/8	4	0339108	-	0339110	0339111	0339113
		2-5/8	5	0339114	-	0339116	0339117	0339119
		3-1/4	6	0339120	-	0339122	0339123	0339125
3/4	3/4	1	3	0339126	-	0339128	0339129	0339131
		1-5/8	4	0339132	-	0339134	0339135	0339137
		2-3/8	5	0339138	-	0339140	0339141	0339143
		3-1/4	6	0339144	-	0339146	0339147	0339149
		4-1/8	7	0339150	-	0339152	0339153	0339155
1	1	1-3/4	4	0339156	-	0339158	0339159	0339161
		2-1/4	5	0339162	-	0339164	0339165	0339167
		3-1/4	6	0339168	-	0339170	0339171	0339173
		4-1/8	7	0339174	-	0339176	0339177	0339179

Cutter Dia d1	Shank Dia d2	Length of Cut l2	Overall Length l1	Order Code SQ	Order Code by Corner Radius					
					0.5 CR	1.0 CR	1.5 CR	2.0 CR	3.0 CR	4.0 CR
10	10	22	72	0339198	0339199	0339200	0339201	-	-	-
		26	83	0339206	0339207	0339208	0339209	-	-	-
12	12	32	83	-	0853512	0853513	0853516	0853532	0853540	0853543
		34	92	0339218	0339219	0339220	0339221	-	-	-
		42	92	-	0440705	0853544	-	0853550	0853551	0853563
20	20	42	104	0339230	0339231	0339232	0339233	-	-	-
		52	104	-	0853571	0853579	-	0853584	0853600	0853601

Cutter Dia d1	Shank Dia d2	Length of Cut l2	Reach LBS l3	Overall Length l1	Order Code by Corner Radius		
					0.5 CR	1.0 CR	3.0 CR
12	12	26	55	100	0853602	0853603	0853604
16	16	34	75	125	0853607	0853609	0853633
20	20	42	100	150	0853635	0853637	0853638

M527N

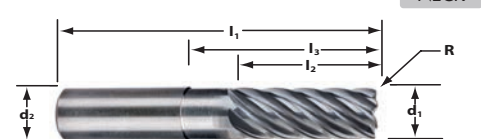

mm: d1: +0.000 / -0.050 d2: -0.0025 / -0.0100

M527C enDURO



For high-performance machining in materials ranging from low carbon steels to titanium. Adds the benefits of the unique **Chip Management System (CMS)** to the versatility of the M527 design. Breaks up long, stringy chips, which eliminates recutting chips and chip packing, and allows for free cutting tool movement in a variety of materials. The results are great chip control and very high metal removal rates.

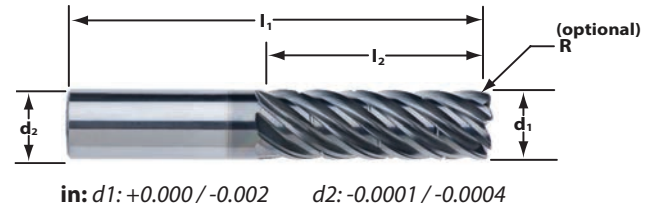

Cutter Dia d1	Shank Dia d2	Length of Cut L2	Overall Length L1	Order Code SQ	Order Code by Corner Radius		
					.015 CR	.030 CR	.060 CR
1/2	1/2	2-1/8	4	0339250	0339251	0339252	-
		2-5/8	5	0339255	0339256	0339257	-
5/8	5/8	2-1/8	4	0339260	-	0339262	0339263
		2-5/8	5	0339265	-	0339267	0339268
		3-1/4	6	0339270	-	0339272	0339273
3/4	3/4	2-3/8	5	0339275	-	0339277	0339278
		3-1/4	6	0339280	-	0339282	0339283
		4-1/8	7	0339285	-	0339287	0339288
1	1	2-1/4	5	0339290	-	0339292	0339293
		3-1/4	6	0339295	-	0339297	0339298
		4-1/8	7	0339300	-	0339302	0339303

TOOL TIP

CMS: Stop Chip Pollution.

Controlling chip size and clearing the chips from the cutting zone are important when machining in all tools paths, but they become critical in traditional slotting and when using HEM paths. IMCO's CMS is a unique edge treatment design that breaks materials into smaller, more manageable chips. CMS helps improve the effectiveness of the coolant or air blasts in evacuating the chips from the cutting zone, preventing chip packing and recutting – improving tool life and performance.



Chip pollution caused by a non-CMS tool. ►

M527 Application Guide – Speed & Feed (inch)

ISO Code	Work Material	Type of Cut	Axial DOC	Radial DOC	No. of Flutes	Speed (SFM)	Feed (Inch per Tooth)				
							3/8	1/2	5/8	3/4	1
K	Cast Iron Gray	Slotting	.5 x D	1 x D	7	300	.0013	.0018	.0022	.0027	.0035
		Peripheral - Rough	1.25 x D	.3 x D	7	375	.0018	.0023	.0029	.0035	.0047
		Finish	2 x D	.015 x D	7	450	.0018	.0024	.0030	.0036	.0048
	Cast Iron	Slotting	.5 x D	1 x D	7	275	.0011	.0014	.0018	.0021	.0029
		Peripheral - Rough	1.25 x D	.3 x D	7	350	.0015	.0019	.0024	.0029	.0039
		Peripheral - HEM*	3 x D	.05 x D	7	390	.0043	.0057	.0071	.0085	.0114
	Finish	2 x D	.015 x D	7	350	.0015	.0020	.0025	.0030	.0040	
P	Low Carbon Steels ≤ 38 Rc 1018, 1020, 12L14, 5120, 8620	Slotting	.5 x D	1 x D	7	325	.0015	.0020	.0025	.0030	.0040
		Peripheral - Rough	1.25 x D	.3 x D	7	400	.0020	.0027	.0034	.0041	.0055
		Peripheral - HEM*	3 x D	.05 x D	7	450	.0066	.0088	.0109	.0131	.0175
		Finish	2 x D	.015 x D	7	400	.0021	.0028	.0035	.0042	.0056
	Medium Carbon Steels ≤ 48 HRC 1045, 4140, 4340, 5140	Slotting	.5 x D	1 x D	7	300	.0014	.0018	.0023	.0027	.0037
		Peripheral - Rough	1.25 x D	.3 x D	7	375	.0019	.0025	.0031	.0037	.0050
		Peripheral - HEM*	3 x D	.05 x D	7	415	.0064	.0086	.0107	.0129	.0172
		Finish	2 x D	.015 x D	7	375	.0019	.0025	.0032	.0038	.0051
	Tool and Die Steels ≤ 48 Rc A2, D2, O1, S7, P20, H13	Slotting	.5 x D	1 x D	7	275	.0012	.0015	.0019	.0023	.0031
		Peripheral - Rough	1.25 x D	.3 x D	7	350	.0016	.0021	.0026	.0032	.0042
		Peripheral - HEM*	3 x D	.05 x D	7	390	.0055	.0074	.0092	.0110	.0147
		Finish	2 x D	.015 x D	7	350	.0016	.0021	.0027	.0032	.0043
M	Martensitic & Ferritic Stainless Steels 410, 416, 440	Slotting	.5 x D	1 x D	7	300	.0014	.0018	.0023	.0027	.0037
		Peripheral - Rough	1.25 x D	.3 x D	7	375	.0019	.0025	.0031	.0037	.0050
		Peripheral - HEM*	3 x D	.05 x D	7	415	.0064	.0086	.0107	.0129	.0172
		Finish	2 x D	.015 x D	7	375	.0019	.0025	.0032	.0038	.0051
	Austenitic Stainless Steels, FeNi Alloys 303, 304, 316, Invar, Kovar	Slotting	.5 x D	1 x D	7	275	.0013	.0017	.0021	.0026	.0034
		Peripheral - Rough	1.25 x D	.3 x D	7	350	.0018	.0023	.0029	.0035	.0047
		Peripheral - HEM*	3 x D	.05 x D	7	390	.0063	.0083	.0104	.0125	.0167
		Finish	2 x D	.015 x D	7	350	.0018	.0024	.0030	.0036	.0048
	Precipitation Hardening Stainless Steels 17-4, 15-5	Slotting	.5 x D	1 x D	7	250	.0011	.0014	.0018	.0021	.0029
		Peripheral - Rough	1.25 x D	.3 x D	7	325	.0015	.0019	.0024	.0029	.0039
		Peripheral - HEM*	3 x D	.05 x D	7	360	.0050	.0067	.0083	.0100	.0133
		Finish	1.5 x D	.015 x D	7	325	.0015	.0020	.0025	.0030	.0040
S	Titanium Alloys 6Al-4V, 6-2-4	Slotting	.5 x D	1 x D	7	250	.0010	.0013	.0016	.0020	.0026
		Peripheral - Rough	1 x D	.3 x D	7	300	.0013	.0018	.0022	.0027	.0036
		Peripheral - HEM*	3 x D	.05 x D	7	330	.0047	.0063	.0079	.0095	.0126
		Finish	1.5 x D	.015 x D	7	300	.0014	.0018	.0023	.0027	.0036
	Difficult-to-Machine Titanium Alloys 10-2-3 Precipitation Hardening Stainless Steel M 13-8	Slotting	.25 x D	1 x D	7	200	.0007	.0010	.0012	.0015	.0019
		Peripheral - Rough	1 x D	.25 x D	7	250	.0011	.0014	.0018	.0021	.0028
		Peripheral - HEM*	3 x D	.05 x D	7	275	.0037	.0049	.0061	.0073	.0098
		Finish	1.5 x D	.01 x D	7	250	.0012	.0016	.0021	.0025	.0033

D = Tool Diameter *HEM = High-efficiency machining (chip thinning calculations have already been applied to HEM parameters shown).

≈ Approximately Equals < Less Than
 ≤ Less Than or Equal To > Greater Than
 ≥ Greater Than or Equal To = Equals
 x Multiply

Common Machining Formulas

$$RPM = \frac{SFM \times 3.82}{D}$$

$$SFM = RPM \times D \times .262$$

$$IPM = RPM \times IPT \times Z$$

$$MRR = RDOC \times ADOC \times IPM$$

$$RPM = \frac{M/min \times 318.3}{D}$$

$$M/min = RPM \times D \times .00314$$

$$MMPM = RPM \times MMPT \times Z$$

$$MRR = RDOC \times ADOC \times MMPM$$

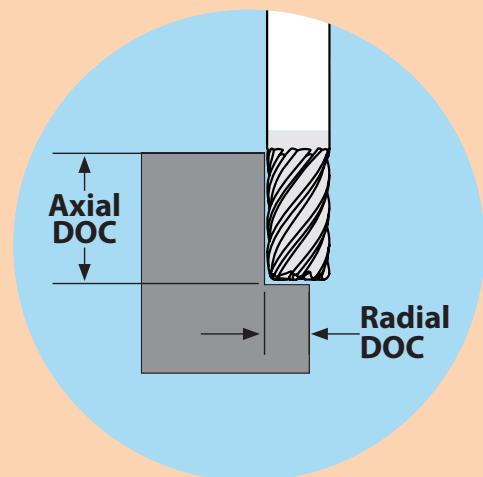

M527 Application Guide – Speed & Feed (metric)

ISO Code	Work Material	Type of Cut	Axial DOC	Radial DOC	No. of Flutes	Speed (M/min)	Feed (MM per Tooth)				
							10.0	12.0	16.0	20.0	25.0
K	Cast Iron Gray	Slotting	.5 x D	1 x D	7	91	.0353	.0425	.0566	.0706	.0886
		Peripheral - Rough	1.25 x D	.3 x D	7	114	.0467	.0563	.0749	.0935	.1173
		Finish	2 x D	.015 x D	7	137	.0476	.0573	.0762	.0951	.1194
	Cast Iron	Slotting	.5 x D	1 x D	7	84	.0285	.0343	.0456	.0569	.0714
		Peripheral - Rough	1.25 x D	.3 x D	7	107	.0388	.0468	.0622	.0776	.0974
		Peripheral - HEM*	3 x D	.05 x D	7	119	.1133	.1365	.1816	.2266	.2844
	Finish	2 x D	.015 x D	7	107	.0395	.0476	.0633	.0790	.0992	
P	Low Carbon Steels ≤ 38 Rc 1018, 1020, 12L14, 5120, 8620	Slotting	.5 x D	1 x D	7	99	.0398	.0480	.0638	.0797	.1000
		Peripheral - Rough	1.25 x D	.3 x D	7	122	.0543	.0655	.0871	.1087	.1364
		Peripheral - HEM*	3 x D	.05 x D	7	137	.1743	.2100	.2793	.3486	.4375
		Finish	2 x D	.015 x D	7	122	.0553	.0666	.0886	.1106	.1388
	Medium Carbon Steels ≤ 48 HRC 1045, 4140, 4340, 5140	Slotting	.5 x D	1 x D	7	91	.0364	.0439	.0584	.0729	.0914
		Peripheral - Rough	1.25 x D	.3 x D	7	114	.0497	.0599	.0796	.0994	.1247
		Peripheral - HEM*	3 x D	.05 x D	7	126	.1708	.2058	.2737	.3417	.4288
		Finish	2 x D	.015 x D	7	114	.0506	.0609	.0810	.1011	.1269
	Tool and Die Steels ≤ 48 Rc A2, D2, O1, S7, P20, H13	Slotting	.5 x D	1 x D	7	84	.0307	.0370	.0493	.0615	.0772
		Peripheral - Rough	1.25 x D	.3 x D	7	107	.0419	.0505	.0672	.0838	.1052
		Peripheral - HEM*	3 x D	.05 x D	7	119	.1464	.1764	.2346	.2929	.3675
		Finish	2 x D	.015 x D	7	107	.0427	.0514	.0684	.0853	.1071
M	Martensitic & Ferritic Stainless Steels 410, 416, 440	Slotting	.5 x D	1 x D	7	91	.0364	.0439	.0584	.0729	.0914
		Peripheral - Rough	1.25 x D	.3 x D	7	114	.0497	.0599	.0796	.0994	.1247
		Peripheral - HEM*	3 x D	.05 x D	7	126	.1708	.2058	.2737	.3417	.4288
		Finish	2 x D	.015 x D	7	114	.0506	.0609	.0810	.1011	.1269
	Austenitic Stainless Steels, FeNi Alloys 303, 304, 316, Invar, Kovar	Slotting	.5 x D	1 x D	7	84	.0341	.0411	.0547	.0683	.0857
		Peripheral - Rough	1.25 x D	.3 x D	7	107	.0466	.0561	.0746	.0931	.1169
		Peripheral - HEM*	3 x D	.05 x D	7	119	.1660	.2000	.2660	.3320	.4166
		Finish	2 x D	.015 x D	7	107	.0474	.0571	.0760	.0948	.1190
	Precipitation Hardening Stainless Steels 17-4, 15-5	Slotting	.5 x D	1 x D	7	76	.0285	.0343	.0456	.0569	.0714
		Peripheral - Rough	1.25 x D	.3 x D	7	99	.0388	.0468	.0622	.0776	.0974
		Peripheral - HEM*	3 x D	.05 x D	7	110	.1328	.1600	.2128	.2656	.3333
		Finish	1.5 x D	.015 x D	7	99	.0395	.0476	.0633	.0790	.0992
S	Titanium Alloys 6Al-4V, 6-2-4	Slotting	.5 x D	1 x D	7	76	.0262	.0315	.0420	.0524	.0657
		Peripheral - Rough	1 x D	.3 x D	7	91	.0357	.0430	.0572	.0714	.0896
		Peripheral - HEM*	3 x D	.05 x D	7	101	.1257	.1515	.2015	.2515	.3156
		Finish	1.5 x D	.015 x D	7	91	.0363	.0438	.0582	.0727	.0912
	Difficult-to-Machine Titanium Alloys 10-2-3 Precipitation Hardening Stainless Steels M 13-8	Slotting	.25 x D	1 x D	7	61	.0193	.0233	.0310	.0387	.0486
		Peripheral - Rough	1 x D	.25 x D	7	76	.0279	.0336	.0447	.0558	.0701
		Peripheral - HEM*	3 x D	.05 x D	7	84	.0975	.1175	.1563	.1950	.2448
		Finish	1.5 x D	.01 x D	7	76	.0328	.0395	.0526	.0656	.0824

D = Tool Diameter *HEM = High-efficiency machining (chip thinning calculations have already been applied to HEM parameters shown)

- D** Tool Diameter
- Z** Number of Flutes
- RPM** Revolutions per Minute
- SFM** Surface Feet per Minute
- M/min** Surface Meters per Minute
- IPM** Inches per Minute
- MMPM** Millimeters per Minute
- IPT** Inch per Tooth
- MMPT** Millimeters per Tooth
- MRR** Metal Removal Rate
- RDOC** Radial Depth of Cut
- ADOC** Axial Depth of Cut

Technical Resources

Information on tips and adjustments for the following milling operations can be found in our Technical Resources section beginning on page 134.

- HEM slotting
- Face milling
- Helical entry ramping
- Straight line ramping
- Long tool projection adjustments
- Ball nose milling adjustments
- Other helpful tips and calculations

M503 enDURO



For general machining in carbon and stainless steels, as well as copper alloys. The 3-flute design of the M503 combines the strength of high-shear cutting edges and advanced AlTiN coating with the flute spacing to help evacuate gummy chips. Use with traditional machining techniques only.

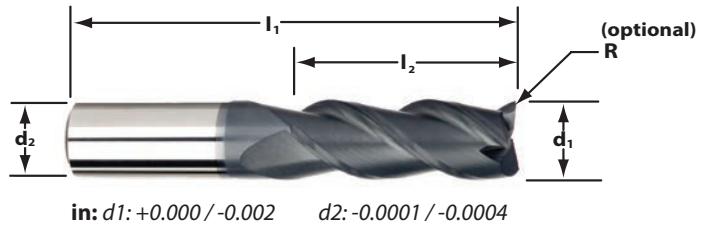

Cutter Dia d1	Shank Dia d2	Length of Cut L2	Overall Length L1	Order Code SQ	Order Code by Corner Radius		
					.015 CR	.020 CR	.030 CR
1/8	1/8	1/4	1-1/2	-	0335471	-	-
		1/2	1-1/2	0335221	0335196	-	-
3/16	3/16	5/16	2	-	0335472	-	-
		9/16	2	0335222	0335197	-	-
1/4	1/4	3/8	2	-	-	0335473	-
		3/4	2-1/2	0335223	-	0335198	-
3/8	3/8	1/2	2	-	-	-	0335474
		1	2-1/2	0335227	-	-	0335202
1/2	1/2	5/8	2-1/2	-	-	-	0335475
		1-1/4	3	0335229	-	-	0335204

M503 Application Guide – Speed & Feed (inch)

ISO Code	Work Material	Type of Cut	Axial DOC	Radial DOC	No. of Flutes	Speed (SFM)	Feed (inch per Tooth)				
							1/8	3/16	1/4	3/8	1/2
P	Low Carbon Steels 1018, 12L14, 8620	Slotting	1 x D	1 x D	3	325	.0006	.0009	.0012	.0018	.0024
		Rough	1.25 x D	.5 x D	3	375	.0008	.0011	.0015	.0023	.0030
		Finish	1.5 x D	.01 x D	3	425	.0010	.0014	.0019	.0029	.0038
	Medium Carbon Steels 4140, 4340	Slotting	.75 x D	1 x D	3	275	.0005	.0008	.0011	.0016	.0021
		Rough	1.25 x D	.3 x D	3	350	.0006	.0009	.0012	.0018	.0024
		Finish	1.5 x D	.01 x D	3	375	.0007	.0011	.0014	.0021	.0028
M	Martensitic Stainless Steels 416, 410, 440C	Slotting	.75 x D	1 x D	3	275	.0006	.0008	.0011	.0017	.0022
		Rough	1.25 x D	.3 x D	3	350	.0007	.0011	.0014	.0021	.0028
		Finish	1.5 x D	.01 x D	3	375	.0009	.0013	.0018	.0026	.0035
	Austenitic Stainless Steels 303, 304, 316	Slotting	.75 x D	1 x D	3	250	.0005	.0007	.0009	.0014	.0018
		Rough	1.25 x D	.3 x D	3	300	.0006	.0009	.0012	.0018	.0024
		Finish	1.5 x D	.01 x D	3	350	.0008	.0011	.0015	.0023	.0030
	Precipitation Hardening Stainless Steels 17-4, 15-5	Slotting	.5 x D	1 x D	3	225	.0004	.0005	.0007	.0011	.0014
		Rough	1.25 x D	.3 x D	3	275	.0004	.0006	.0009	.0013	.0017
		Finish	1.5 x D	.01 x D	3	325	.0006	.0009	.0013	.0019	.0025
N	Copper, Brass, & Bronze	Slotting	1 x D	1 x D	3	450	.0008	.0011	.0015	.0023	.0030
		Rough	1.25 x D	.5 x D	3	550	.0009	.0013	.0018	.0026	.0035
		Finish	1.5 x D	.01 x D	3	600	.0010	.0015	.0021	.0031	.0041
	Bronze & Beryllium Copper	Slotting	.5 x D	1 x D	3	275	.0005	.0008	.0010	.0015	.0020
		Rough	1.25 x D	.5 x D	3	350	.0006	.0009	.0013	.0019	.0025
		Finish	1.5 x D	.01 x D	3	375	.0007	.0011	.0015	.0022	.0029

D = Tool Diameter

Information on tips and adjustments can be found in our Technical Resources section beginning on page 134.

≈ Approximately Equals < Less Than
 ≤ Less Than or Equal To > Greater Than
 ≥ Greater Than or Equal To = Equals
 x Multiply

Common Machining Formulas

$$\text{RPM} = \frac{\text{SFM} \times 3.82}{D}$$

$$\text{SFM} = \text{RPM} \times D \times .262$$

$$\text{IPM} = \text{RPM} \times \text{IPT} \times Z$$

$$\text{MRR} = \text{RDOC} \times \text{ADOC} \times \text{IPM}$$

- D Tool Diameter
- Z Number of Flutes
- RPM Revolutions per Minute
- SFM Surface Feet per Minute
- IPM Inches per Minute
- IPT Inch per Tooth
- MRR Metal Removal Rate
- RDOC Radial Depth of Cut
- ADOC Axial Depth of Cut

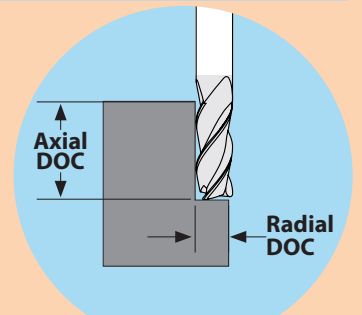



OMEGA-6™

PERFORMANCE TO THE SIXTH POWER.

The Omega-6 end mill demonstrates remarkably longer tool life in hardened steels, even up to 58-62 HRC, running wet or dry. This tool excels in hardened materials, and it provides superior finishes in a wide range of non-hardened materials.



M7 Series Features

HARD CORE FOR HARD WORK.

The Omega-6 is a purpose-driven end mill for machining in hard metal applications. Available in both the second (M725/726) and first (M706) generations. Engineered with strong cutting edges and a thick core for long tool life when machining steels up to 62 HRC. Heat-resistant coating yields great tool performance in both wet and dry machining conditions. An excellent tool for finishing applications in a wide range of materials.



	M725	M726	M725N	M726N	M706	M706N
NUMBER OF FLUTES	Z5	Z6	Z5	Z6	Z6	Z6
END TYPES	SQ CR	SQ CR	CR	CR	SQ CR	SQ CR
HELIX ANGLE	50°	50°	50°	50°	40°	40°
COATING	AlTiN	AlTiN	AlTiN	AlTiN	AlTiN	AlTiN
SHANK TYPES	PLAIN	PLAIN WELDON	PLAIN NECK	PLAIN NECK	PLAIN WELDON	PLAIN WELDON NECK
APPLICATIONS	ROUGH FINISH					
MATERIAL(S)						

M725/M726

OMEGA-6



For hardened steels and general finishing applications. The second generation of the Omega-6 end mill. The M725/726 series uses a high-strength core, reinforced cutting edges, and a heat-resistant coating to yield long tool life in difficult machining conditions. Best when hard milling in materials up to 62 HRC and when finishing in a wide range of materials.

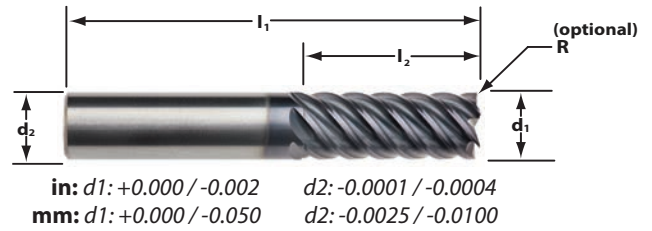

Cutter Dia d1	Shank Dia d2	Length of Cut L2	Overall Length L1	Number of Flutes	Order Code SQ	Order Code by Corner Radius		
						.015 CR	.030 CR	.060 CR
1/8	1/8	1/4	1-1/2	5	0337576	0337577	-	-
		1/2	1-1/2	5	0337578	0337579	-	-
3/16	3/16	5/16	2	5	0337580	0337581	-	-
		9/16	2	5	0337582	0337583	-	-
1/4	1/4	3/4	2-1/2	6	0337584	0337585	0337586	-
		1-1/4	3	6	0337587	0337588	0337589	-
3/8	3/8	7/8	2-1/2	6	0337590	0337591	0337592	-
		1-1/4	3	6	0337593	0337594	0337595	-
		2	4	6	0337596	0337597	0337598	-
1/2	1/2	1	3	6	0337599	0337600	0337601	0337602
		1-1/4	3	6	0337603	0337604	0337605	0337606
		1-5/8	3-1/2	6	0337607	0337608	0337609	0337610
		2-1/8	4	6	0337611	0337612	0337613	0337614
		2-5/8	5	6	0337615	0337616	0337617	0337618
5/8	5/8	1-3/8	3-1/2	6	0337619	-	0337620	0337621
		1-7/8	4	6	0337622	-	0337623	0337624
		2-5/8	5	6	0337625	-	0337626	0337627
3/4	3/4	1-5/8	4	6	0337628	-	0337629	0337630
		2-5/8	5	6	0337631	-	0337632	0337633
		3-3/8	6	6	0337634	-	0337635	0337636

Cutter Dia d1	Shank Dia d2	Length of Cut L2	Overall Length L1	Number of Flutes	Order Code SQ	Order Code by Corner Radius		
						.015 CR	.030 CR	.060 CR
3/8	3/8	7/8	2-1/2	6	0337696	0337697	0337698	-
		1-1/4	3	6	0337699	0337700	0337701	-
		2	4	6	0337702	0337703	0337704	-
1/2	1/2	1	3	6	0337705	0337706	0337707	0337708
		1-1/4	3	6	0337709	0337710	0337711	0337712
		1-5/8	3-1/2	6	0337713	0337714	0337715	0337716
		2-1/8	4	6	0337717	0337718	0337719	0337720
5/8	5/8	2-5/8	5	6	0337721	0337722	0337723	0337724
		1-3/8	3-1/2	6	0337725	-	0337726	0337727
		1-7/8	4	6	0337728	-	0337729	0337730
3/4	3/4	2-5/8	5	6	0337731	-	0337732	0337733
		1-5/8	4	6	0337734	-	0337735	0337736
		2-5/8	5	6	0337737	-	0337738	0337739
		3-3/8	6	6	0337740	-	0337741	0337742

M726 w/WELDON

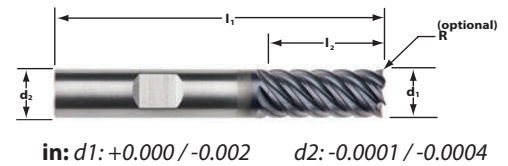

Cutter Dia d1	Shank Dia d2	Length of Cut l2	Overall Length l1	Number of Flutes	Order Code SQ	Order Code by Corner Radius			
						0.3 CR	0.5 CR	1.0 CR	1.5 CR
3	3	6	38	5	0337637	0337638	-	-	-
		8	38	5	0337639	0337640	-	-	-
4	4	7	50	5	0337641	0337642	-	-	-
		11	50	5	0337643	0337644	-	-	-
5	5	8	50	5	0337645	0337646	-	-	-
		13	50	5	0337647	0337648	-	-	-
6	6	13	57	6	0337649	-	0337650	-	-
		25	75	6	0337651	-	0337652	-	-
8	8	19	63	6	0337653	-	0337654	-	-
		32	75	6	0337655	-	0337656	-	-
10	10	22	72	6	0337657	-	0337658	0337659	-
		40	88	6	0337660	-	0337661	0337662	-
		46	100	6	0337663	-	0337664	0337665	-
12	12	26	83	6	0337666	-	0337667	0337668	0337669
		50	100	6	0337670	-	0337671	0337672	0337673
		65	125	6	0337674	-	0337675	0337676	0337677
16	16	32	92	6	0337678	-	-	0337679	0337680
		55	110	6	0337681	-	-	0337682	0337683
		65	125	6	0337684	-	-	0337685	0337686
20	20	38	104	6	0337687	-	-	0337688	0337689
		65	125	6	0337690	-	-	0337691	0337692
		85	150	6	0337693	-	-	0337694	0337695



TOOL TIP

Eliminate Wall Taper when Finishing.

Step 1

Run finish pass using speed, feed, step-over (RDOC) and depth of cut (ADOC) values shown in the speed and feed charts.

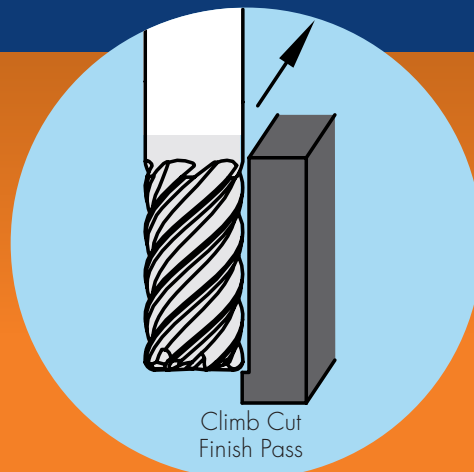

Step 2

Re-run the finish pass using the same speeds and feeds but in the CONVENTIONAL direction. Simply retrace the prior finish pass – do not program to remove more stock. This skim pass will help eliminate taper caused by tool deflection during the first finish pass.

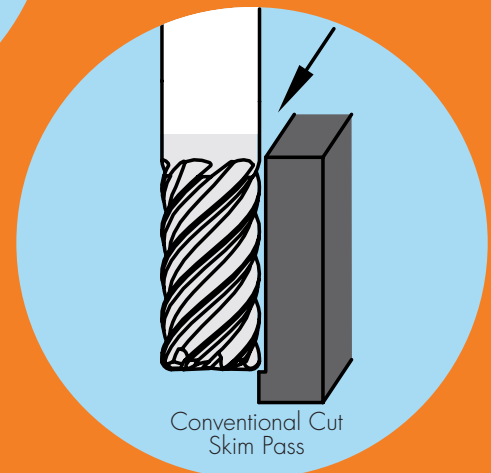

M725N/M726N

OMEGA-6



For hardened steels and general finishing applications. Adding a necked shank to the M725/M726 design offers a high-performance tool that permits clearance in deeper cavities and easier machining against tight walls. Neck relief and short flute length combine to increase end mill stability in the cut for more precise tolerances. Great for work in pockets.

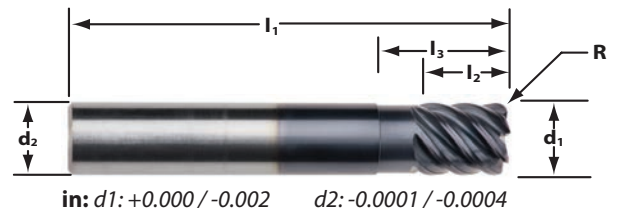

Cutter Dia d1	Shank Dia d2	Length of Cut l2	Reach l3	Overall Length l1	Number of Flutes	Order Code by Corner Radius	
						.015 CR	.030 CR
1/8	1/8	1/4	1/2	1-1/2	5	0337791	-
		1/4	1-1/8	2-1/2	5	0337902	-
3/16	3/16	5/16	9/16	2	5	0337795	-
		3/8	1-3/8	3	5	0337904	-
1/4	1/4	3/8	5/8	2-1/2	6	0337799	-
		5/8	1-3/8	3	6	0337906	-
		5/8	2-3/8	4	6	0337909	-
3/8	3/8	1/2	3/4	2-1/2	6	-	0337809
		7/8	1-3/8	3	6	-	0337913
		7/8	2-3/8	4	6	-	0337916
1/2	1/2	5/8	1-3/8	3	6	-	0337919
		1-1/8	1-3/4	3-1/2	6	-	0337923
		1-1/8	2-1/4	4	6	-	0337927
		1-1/8	3-1/4	5	6	-	0337931
5/8	5/8	1-1/8	2-1/8	4	6	-	0337937
		1-3/8	3-1/8	5	6	-	0337940
3/4	3/4	1-1/8	2	4	6	-	0337943
		1-5/8	2-7/8	5	6	-	0337946
		1-5/8	3-7/8	6	6	-	0337949

M726N OMEGA-6

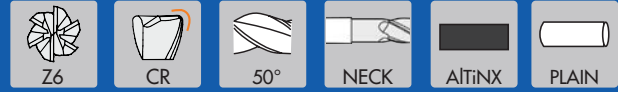

For hardened steels and general finishing applications. Adding a necked shank to the M726 design offers a high-performance tool that permits clearance in deeper cavities and easier machining against tight walls. Neck relief and short flute length combine to increase end mill stability in the cut for more precise tolerances. Great for work in pockets.

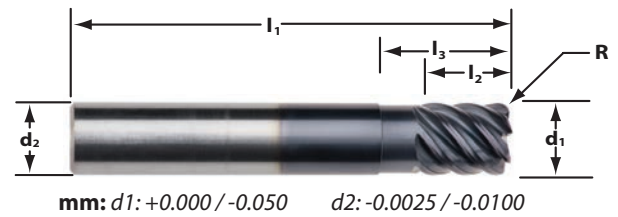

Cutter Dia d1	Shank Dia d2	Length of Cut l2	Reach LBS		Overall Length l1	Number of Flutes	Order Code by Corner Radius	
			l3				0.5 CR	1.0 CR
6	6	9	15	57	6	0337851	-	
		15	39	75	6	0337952	-	
		15	64	100	6	0337954	-	
8	8	11	17	63	6	0337857	-	
		19	39	75	6	0337956	-	
		19	64	100	6	0337958	-	
10	10	13	32	72	6	0337960	-	
		23	48	88	6	0337963	-	
		23	60	100	6	0337966	-	
12	12	15	38	83	6	-	0337970	
		27	55	100	6	-	0337974	
		27	80	125	6	-	0337978	
16	16	20	44	92	6	-	0337981	
		35	62	110	6	-	0337984	
		35	77	125	6	-	0337987	
20	20	24	54	104	6	-	0337990	
		43	75	125	6	-	0337993	
		43	100	150	6	-	0337996	

TOOL TIP

OMEGA-6: MAX Heat. MAX Hardness. MAX Performance.

Some tools are just made for tough cutting conditions. The M7 series of end mills are that kind of tool. The Omega-6 is designed for hard milling in dry conditions — something that makes many tools have a meltdown.

High-shear cutting action, reinforced cutting edges, and a heat-resistant coating combine to allow Omega-6 end mills to machine hardened tool steels with just an air blast — without sacrificing tool life — making it great for machining new molds or repairing used ones.

M7 tools are also versatile — they can run wet or dry — giving you the option of what best fits your shop. Omega-6 can also generate a great finish in a wide variety of materials.



M706 OMEGA-6



For hardened steels and general finishing applications. The first-generation Omega-6 design offers reliable tool life in hardened steels. The M706 is a proven winner in wet or dry machining of materials up to 62 HRC.

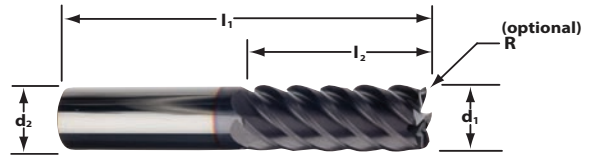

in: $d1: +0.000 / -0.002$ $d2: -0.0001 / -0.0004$



Cutter Dia d1	Shank Dia d2	Length of Cut l2	Overall Length l1	Order Code SQ	Order Code by Corner Radius		
					.015 CR	.020 CR	.030 CR
1/8	1/8	1/4	1-1/2	0335642	0335502	-	-
		1/2	1-1/2	0335360	0335370	-	-
3/16	3/16	5/16	2	0335643	0335503	-	-
		9/16	2	0335361	0335371	-	-
1/4	1/4	3/8	2-1/2	0335644	-	0335504	-
		3/4	2-1/2	0335362	-	0335372	0335417
5/16	5/16	13/16	2-1/2	0335363	-	-	0335373
3/8	3/8	1/2	2-1/2	0335645	-	-	0335505
		1	2-1/2	0335364	-	-	0335374
1/2	1/2	5/8	3	0335646	-	-	0335506
		1-1/4	3	0335366	-	-	0335376
5/8	5/8	3/4	3-1/2	0335647	-	-	0335507
		1-5/8	3-1/2	0335367	-	-	0335377
3/4	3/4	1	4	0335648	-	-	0335508
		1-5/8	4	0335368	-	-	0335378
1	1	2	4	0335369	-	-	0335379

Cutter Dia d1	Shank Dia d2	Length of Cut l2	Overall Length l1	Order Code SQ	Order Code by Corner Radius	
					.020 CR	.030 CR
1/4	1/4	3/4	2-1/2	0332137	0332187	0335422
3/8	3/8	1	2-1/2	0332139	-	0332189
1/2	1/2	1-1/4	3	0332141	-	0332191
5/8	5/8	1-5/8	3-1/2	0332142	-	0332193
3/4	3/4	1-5/8	4	0332143	-	0332194
1	1	2	4	0332144	-	0335380

M706 w/WELDON

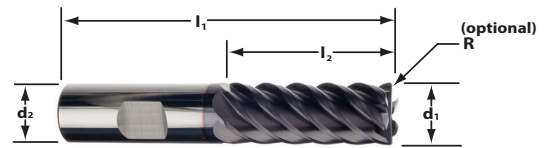

in: $d1: +0.000 / -0.002$ $d2: -0.0001 / -0.0004$

M706N OMEGA-6



For hardened steels and general finishing applications. Adding a necked shank to the M706 design offers a high-performance tool that permits clearance in deeper cavities and easier machining against tight walls. Neck relief and short flute length combine to increase end mill stability in the cut for more precise tolerances. Great for work in pockets.

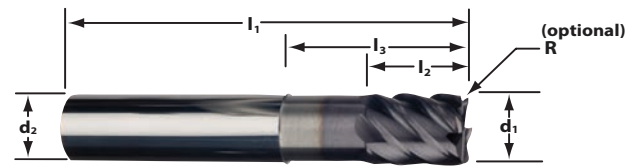

in: $d1: +0.000 / -0.002$ $d2: -0.0001 / -0.0004$



Cutter Dia d1	Shank Dia d2	Length of Cut I2	Reach LBS I3	Overall Length I1	Order Code SQ	Order Code by Corner Radius			
						.015 CR	.020 CR	.030 CR	.060 CR
1/8	1/8	1/4	1/2	1-1/2	0335399	0335445	-	-	-
3/16	3/16	5/16	9/16	2	0335400	0335446	-	-	-
1/4	1/4	3/8	1-1/8	2-1/2	0335401	-	0335447	0335448	-
5/16	5/16	7/16	1-1/8	2-1/2	0335402	-	0335449	0335450	-
3/8	3/8	1/2	1-1/8	2-1/2	0335403	-	0335451	0335452	0335453
1/2	1/2	5/8	1-3/8	3	0335404	-	0335454	0335455	0335456
3/4	3/4	1	1-3/4	4	0335406	-	-	0335458	0335459

Cutter Dia d1	Shank Dia d2	Length of Cut I2	Reach LBS I3	Overall Length I1	Order Code SQ	Order Code by Corner Radius		
						.020 CR	.030 CR	.060 CR
3/8	3/8	1/2	1-1/8	2-1/2	0332413	0332422	0332423	-
1/2	1/2	5/8	1-3/8	3	0332414	0332434	0332435	0332436
3/4	3/4	1	1-3/4	4	0332416	-	0332438	0332439

M706N_w/WELDON

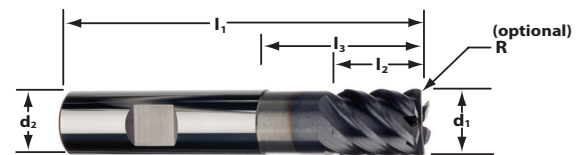

in: $d1: +0.000 / -0.002$ $d2: -0.0001 / -0.0004$

M725/M726 Series Application Guide – Speed & Feed (inch and metric)

INCH										METRIC						
No. of Flutes	Type of Cut	Tool Dia.	Axial Max	Radial Max	Speed (SFM)	RPM	IPT	IPM	Tool Dia.	Axial Max	Radial Max	Speed (M/Min)	RPM	MMPT	MM/Min	
H 51 HRC-63 HRC	5 Rough Rough < 10,000 Finish	1/8	.1250	.0075	350	10,696	.00035	18.7	3.0	3.0	.18	106	11,318	.0089	5039	
			.1250	.0075	325	9,932	.00035	17.4		3.0	.18	94	9,973	.0089	443	
			.2500	.001	300	9,168	.00030	13.7		6.0	.025	91	9,701	.0075	363	
	5	Rough Finish	3/16	.1875	.0130	250	5,093	.00070	17.8	4.0	4.0	.275	64	5,093	.0180	458
				.3750	.0015	300	6,112	.00040	12.2		8.0	.032	91	7,241	.0097	351
	6	Rough Finish	1/4	.2500	.0150	400	6,112	.00100	36.6	5.0	5.0	.345	80	5,093	.0200	509
				.5000	.0020	300	4,584	.00050	13.8		10.0	.050	91	5,793	.0107	309
	6	Rough Finish	5/16	.3125	.0220	400	4,890	.00125	36.6	6.0	6.0	.380	122	6,472	.0254	986
				.6250	.0020	300	3,667	.00060	13.2		12.0	.050	91	4,828	.0127	367
	6	Rough Finish	3/8	.3750	.0300	400	4,074	.00150	36.6	8.0	8.0	.558	121	4,814	.0330	953
.7500				.0030	300	3,056	.00070	12.8	16.0		.050	91	3,621	.0152	330	
6	Rough Finish	1/2	.5000	.0400	400	3,056	.00200	36.6	10.0	10.0	.800	121	3,851	.0400	924	
			1.000	.0030	300	2,292	.00100	13.7		20.0	.076	91	2,897	.0200	347	
6	Rough Finish	5/8	.6250	.0500	400	2,445	.00250	36.6	12.0	12.0	.960	121	3,210	.0480	924	
			1.250	.0050	300	1,833	.00130	14.3		24.0	.076	91	2,414	.0240	347	
6	Rough Finish	3/4	.750	.0600	400	2,037	.00300	36.6	16.0	16.0	1.270	121	2,407	.0635	917	
			1.500	.0050	300	1,528	.00150	13.7		32.0	.127	91	1,810	.0330	358	
6	Rough Finish	1	1.000	.0800	400	1,528	.00400	36.6	20.0	20.0	1.524	121	1,926	.0760	878	
			2.000	.0080	300	1,146	.00200	13.7		40.0	.127	91	1,448	.0380	330	
K H 43 HRC-50 HRC	5 Rough Rough < 10,000 Finish Finish < 10,000	1/8	.1250	.010	500	15,280	.0006	45.8	3.0	3.0	.254	152	16,127	.0152	1225	
			.1250	.010	325	9,932	.0006	29.8		3.0	.254	94	9,973	.0152	758	
			.2500	.001	400	12,224	.0003	18.3		6.0	.025	121	12,838	.0076	487	
			.2500	.001	325	9,932	.0003	14.9		6.0	.025	94	9,973	.0076	379	
	5	Rough Rough < 10,000 Finish	3/16	.1875	.015	500	10,186	.0009	45.8	4.0	4.0	.320	152	12,095	.0192	1161
				.1875	.015	480	9,780	.0009	44.0		4.0	.320	125	9,947	.0192	954
	6	Rough Finish	1/4	.2500	.020	500	8,150	.0005	20.4	5.0	5.0	.400	152	9,629	.0103	495
				.5000	.003	400	6,112	.0007	25.7		10.0	.040	121	7,703	.0132	508
	6	Rough Finish	5/16	.3125	.025	500	6,112	.0014	51.3	6.0	6.0	.480	152	8,064	.0305	1475
				.6250	.003	400	4,889	.0007	20.5		12.0	.075	121	6,419	.0170	654
6	Rough Finish	3/8	.7500	.030	500	5,093	.0017	52.0	8.0	8.0	.640	152	6,048	.0355	1288	
			.7500	.005	400	4,074	.0010	24.4		16.0	.080	121	4,814	.0175	505	
6	Rough Finish	1/2	.5000	.040	500	3,820	.0023	52.7	10.0	10.0	.800	152	4,838	.0453	1315	
			1.0000	.007	400	3,056	.0014	25.6		20.0	.130	121	3,851	.0266	614	
6	Rough Finish	5/8	.6250	.050	500	3,056	.0029	53.2	12.0	12.0	.970	152	4,032	.0552	1335	
			1.2500	.008	400	2,445	.0018	26.4		24.0	.180	121	3,210	.0336	647	
6	Rough Finish	3/4	.7500	.060	500	2,547	.0034	52.0	16.0	16.0	1.280	152	3,024	.0736	1335	
			1.5000	.009	400	2,037	.0020	24.4		32.0	.200	121	2,407	.0455	657	
6	Rough Finish	1	1.0000	.080	500	1,910	.0046	52.7	20.0	20.0	1.600	152	2,419	.0863	1252	
			2.0000	.010	400	1,528	.0023	21.0		40.0	.230	121	1,926	.0508	587	
P M 36 HRC-42 HRC	5 Rough Rough < 10,000 Finish Finish < 10,000	1/8	.1250	.0100	600	18,336	.0010	91.7	3.0	3.0	.240	182	19,310	.0254	2452	
			.1250	.0100	325	9,932	.0010	49.6		3.0	.240	94	9,973	.0254	1266	
			.2500	.0015	450	13,752	.0005	34.4		6.0	.038	137	14,536	.0127	923	
			.2500	.0015	325	9,932	.0005	24.8		6.0	.038	94	9,973	.0127	633	
	5	Rough Rough < 10,000 Finish	3/16	.1875	.0150	600	12,224	.0013	79.5	4.0	4.0	.320	182	14,483	.0280	2027
				.1875	.0150	475	9,677	.0013	63.0		4.0	.320	125	9,947	.0280	1392
	6	Rough Rough < 10,000 Finish	1/4	.2500	.0250	600	9,168	.0020	110.0	5.0	5.0	.400	182	11,586	.0345	1998
				.5000	.0030	500	7,640	.0010	45.8		10.0	.053	137	8,721	.0212	924
	6	Rough Finish	5/16	.3125	.0310	600	7,334	.0025	110.0	6.0	6.0	.600	183	9,708	.0510	2970
				.6250	.0030	500	6,112	.0013	47.6		12.0	.076	152	8,064	.0254	1228
6	Rough Finish	3/8	.3750	.0370	600	6,112	.0030	110.0	8.0	8.0	.800	183	7,281	.0635	2774	
			.7500	.0030	500	5,093	.0015	45.8		16.0	.076	152	6,048	.0330	1197	
6	Rough Finish	1/2	.5000	.0500	600	4,584	.0040	110.0	10.0	10.0	1.000	183	5,825	.0800	2795	
			1.0000	.0050	500	3,820	.0020	45.8		20.0	.076	152	4,838	.0400	1161	
6	Rough Finish	5/8	.6250	.0625	600	3,667	.0050	110.0	12.0	12.0	1.200	183	4,854	.0960	2795	
			1.2500	.0050	500	3,056	.0025	45.8		24.0	120	152	4,032	.0480	1161	
6	Rough Finish	3/4	.7500	.0750	600	3,056	.0060	110.0	16.0	16.0	1.600	183	3,641	.1270	2774	
			1.5000	.0050	500	2,546	.0030	45.8		32.0	.127	152	3,024	.0635	1152	
6	Rough Finish	1	1.0000	.1000	600	2,292	.0080	110.0	20.0	20.0	2.000	183	2,912	.1524	2663	
			2.0000	.0070	500	1,910	.0040	45.8		40.0	.127	152	2,419	.0762	1106	

M706 Application Guide – Speed & Feed (inch)

ISO Code	Tool Dia	Type of Cut	Axial Max	Radial Max	Speed (SFM)	RPM	IPT	IPM
H 51 HRC- 63 HRC	1/8	Roughing	.125	.025	65	1986	.00035	4
		Finishing	.1875	.0015	100	3056	.0004	7
	3/16	Roughing	.1875	.0375	65	1324	.0005	4
		Finishing	.28125	.002	100	2037	.0005	6
	1/4	Roughing	.250	.05	65	993	.0007	4
		Finishing	.375	.003	100	1528	.0007	6
	5/16	Roughing	.3125	.0625	65	795	.0009	4
		Finishing	.46875	.004	100	1222	.0009	6
	3/8	Roughing	.375	.075	65	662	.0011	4
		Finishing	.563	.005	100	1019	.0011	6
	1/2	Roughing	.5	.100	65	497	.0015	4
		Finishing	.375	.007	100	764	.0015	6
5/8	Roughing	.625	.125	65	397	.0019	4	
	Finishing	.938	.010	100	611	.0019	7	
3/4	Roughing	.750	.150	65	331	.0024	4	
	Finishing	1.125	.012	100	509	.0024	7	
1	Roughing	1.000	.200	65	248	.003	4	
	Finishing	1.500	.015	100	382	.003	6	
K H 43 HRC- 50 HRC	1/8	Roughing	.125	.031	200	6112	.0003	11
		Finishing	.1875	.0015	275	8404	.0003	15
	3/16	Roughing	.1875	.047	200	4075	.0005	12
		Finishing	.28125	.002	275	5603	.0005	16
	1/4	Roughing	.250	.063	200	3056	.0007	12
		Finishing	.375	.003	275	4202	.0007	17
	5/16	Roughing	.3125	.078	200	2445	.0009	13
		Finishing	.46875	.004	275	3362	.0009	18
	3/8	Roughing	.375	.094	200	2037	.0011	13
		Finishing	.563	.005	275	2801	.0011	18
	1/2	Roughing	.5	.125	200	1528	.0015	13
		Finishing	.375	.007	275	2101	.0015	18
5/8	Roughing	.625	.156	200	1222	.0018	13	
	Finishing	.938	.010	275	1681	.0018	18	
3/4	Roughing	.750	.188	200	1019	.0022	13	
	Finishing	1.125	.012	275	1401	.0022	18	
1	Roughing	1.000	.250	200	764	.0030	13	
	Finishing	1.500	.015	275	1051	.0030	18	
P M 36 HRC- 42 HRC	1/8	Roughing	.125	.044	250	7640	.0004	18.3
		Finishing	.1875	.002	325	9932	.0004	23.8
	3/16	Roughing	.1875	.065625	250	5093	.0005	15.3
		Finishing	.28125	.004	325	6621	.0006	23.8
	1/4	Roughing	.250	.0875	250	3820	.0007	16
		Finishing	.375	.005	325	4966	.0009	26.8
	5/16	Roughing	.3125	.109	250	3056	.0009	16.5
		Finishing	.46875	.007	325	3973	.0011	26.2
	3/8	Roughing	.375	.132	250	2547	.0011	16.8
		Finishing	.563	.01	325	3311	.0013	25.8
	1/2	Roughing	.5	.175	250	1910	.0015	17.2
		Finishing	.375	.012	325	2483	.0018	26.8
5/8	Roughing	.625	.21875	250	1528	.0019	17.4	
	Finishing	.938	.015	325	1986	.0022	26.2	
3/4	Roughing	.750	.2625	250	1273	.0024	18.3	
	Finishing	1.125	.015	325	1655	.0027	26.8	
1	Roughing	1.000	.350	250	955	.003	17.2	
	Finishing	1.500	.015	325	1242	.0036	26.8	

D = Tool Diameter

≈	Approximately Equals	<	Less Than
≤	Less Than or Equal To	>	Greater Than
≥	Greater Than or Equal To	=	Equals
x	Multiply		

Common Machining Formulas

$$RPM = \frac{SFM \times 3.82}{D}$$

$$SFM = RPM \times D \times .262$$

$$IPM = RPM \times IPT \times Z$$

$$MRR = RDOC \times ADOC \times IPM$$

$$RPM = \frac{M/min \times 318.3}{D}$$

$$M/min = RPM \times D \times .00314$$

$$MMPM = RPM \times MMPT \times Z$$

$$MRR = RDOC \times ADOC \times MMPM$$

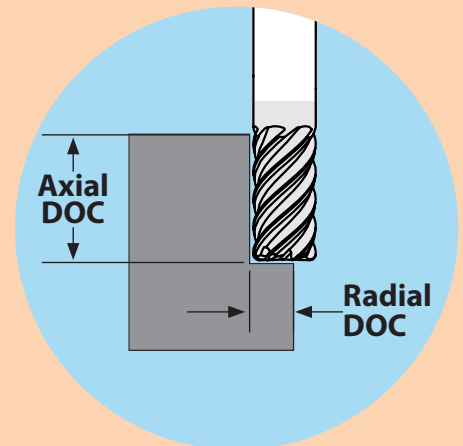

D Tool Diameter

Z Number of Flutes

RPM Revolutions per Minute

SFM Surface Feet per Minute

M/min Surface Meters per Minute

IPM Inches per Minute

MMPM Millimeters per Minute

IPT Inch per Tooth

MMPT Millimeters per Tooth

MRR Metal Removal Rate

RDOC Radial Depth of Cut

ADOC Axial Depth of Cut

Technical Resources

Information on tips and adjustments for the following milling operations can be found in our Technical Resources section beginning on page 134.

- HEM slotting
- Face milling
- Helical entry ramping
- Straight line ramping
- Long tool projection adjustments
- Ball nose milling adjustments
- Other helpful tips and calculations

INCONEX[®]

WORK EXTRA-LONG IN EXTRA-DIFFICULT METALS.

The INCONEX M8 end mills are designed specifically for higher productivity in all hi-temp alloys. Optimized geometries, advanced chip management and proven performance: INCONEX M8 end mills are the best choice for success in difficult-to-machine metals.



M8 Series Features



WORK EXTRA-LONG IN EXTRA-DIFFICULT MATERIALS.

Engineered to meet the challenge of machining hi-temp alloys, the M806 series includes features made specifically with tool life in mind. Great for roughing cuts when using traditional tool paths.



	M806	M806N
NUMBER OF FLUTES	Z6	Z6
END TYPES	CR	CR
HELIX ANGLE	30°	30°
COATING	AlCrNX	AlCrNX
SHANK TYPES	PLAIN WELDON	PLAIN NECK
APPLICATIONS	ROUGH	
MATERIAL(S)	S	



INCONEX: Going the Extra Mile in Hi-Temp Alloys.

In tool development tests against our own tool (M706) and the leading competitors' products for hi-temp alloys, the INCONEX far outlasted all challengers in tool life.

Using our competitors' suggested speeds and feeds (80 SFM at 6 IPM) the INCONEX tools averaged over 2x the tool life of the other brands – even surpassing our own Omega-6 M706.

Total Metal Removed

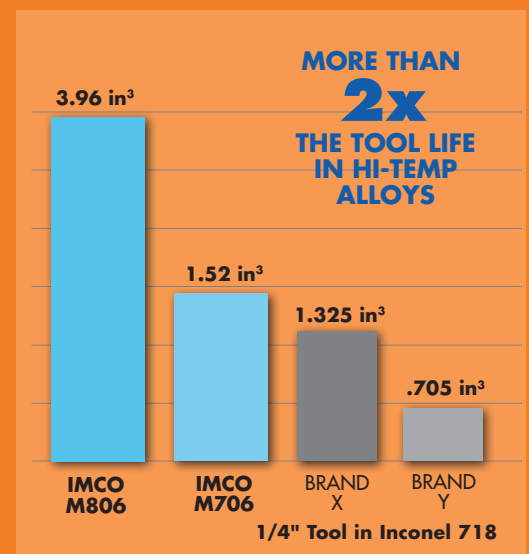

M806 INCONEX



For high-performance roughing in hi-temp alloys. The unique cutting edge design for chip control and the advanced coating reduce heat build-up in the cutting zone for optimized tool performance. The M806 is built for tool life when using traditional tool paths in very difficult-to-machine materials.

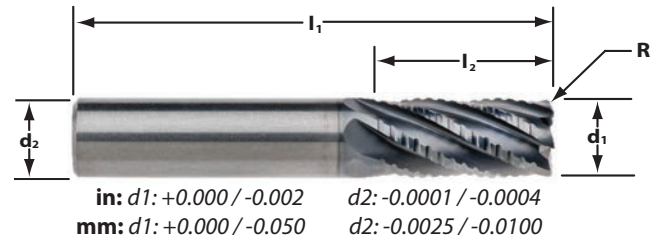

S

Cutter Dia d1	Shank Dia d2	Length of Cut I2	Overall Length I1	Order Code by Corner Radius	
				.015 CR	.030 CR
1/4	1/4	3/8	2	0339333	-
		3/4	2-1/2	0339334	-
5/16	5/16	7/16	2	0339335	-
		13/16	2-1/2	0339336	-
3/8	3/8	1/2	2	-	0339337
		7/8	2-1/2	-	0339338
		1-1/4	3	-	0339340
1/2	1/2	5/8	2-1/2	-	0339342
		1	3	-	0339493
		1-1/4	3	-	0339343
		1-5/8	3-1/2	-	0339345
5/8	5/8	1-3/8	3-1/2	-	0339348
		2	4	-	0339350
3/4	3/4	1-5/8	4	-	0339353
		2-3/8	5	-	0339355
1	1	1-1/2	4	-	0339357
		2-1/2	5	-	0339359

Cutter Dia d1	Shank Dia d2	Length of Cut I2	Overall Length I1	Order Code by Corner Radius	
				0.5 CR	1.0 CR
6	6	13	57	0339361	-
		19	63	0339363	-
8	8	19	63	0339365	-
		25	75	0339367	-
10	10	22	72	-	0339369
		32	80	-	0339371
12	12	26	83	-	0339373
		38	93	-	0339375
16	16	34	92	-	0339377
		50	108	-	0339379
20	20	42	104	-	0339381
		62	125	-	0339383
25	25	52	120	-	0339385

M806_{w/WELDON} INCONEX



For high-performance roughing in hi-temp alloys. The unique cutting edge design for chip control and the advanced coating reduce heat build-up in the cutting zone for optimized tool performance. The M806 is built for tool life when using traditional tool paths in very difficult-to-machine materials.

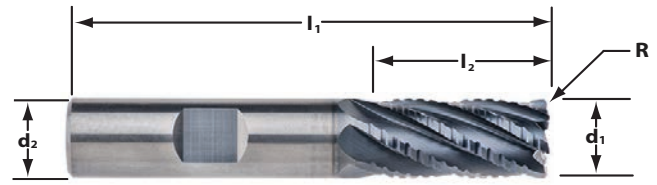

in: d1: +0.000 / -0.002 d2: -0.0001 / -0.0004
mm: d1: +0.000 / -0.050 d2: -0.0025 / -0.0100

S

Cutter Dia d1	Shank Dia d2	Length of Cut I2	Overall Length I1	Order Code .030 CR
3/8	3/8	7/8	2-1/2	0339339
		1-1/4	3	0339341
1/2	1/2	1	3	0339494
		1-1/4	3	0339344
		1-5/8	3-1/2	0339346
5/8	5/8	1-3/8	3-1/2	0339349
		2	4	0339351
3/4	3/4	1-5/8	4	0339354
		2-3/8	5	0339356
1	1	1-1/2	4	0339358
		2-1/2	5	0339360

Cutter Dia d1	Shank Dia d2	Length of Cut I2	Overall Length I1	Order Code by Corner Radius	
				0.5 CR	1.0 CR
6	6	13	57	0339362	-
		19	63	0339364	-
8	8	19	63	0339366	-
		25	75	0339368	-
10	10	22	72	-	0339370
		32	80	-	0339372
12	12	26	83	-	0339374
		38	93	-	0339376
16	16	34	92	-	0339378
		50	108	-	0339380
20	20	42	104	-	0339382
		62	125	-	0339384
25	25	52	120	-	0339386

M806N INCONEX

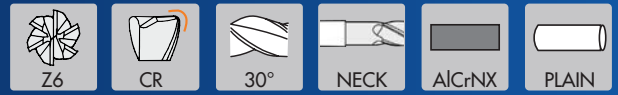

For high-performance roughing in hi-temp alloys. Adding a necked shank to the M806 design offers a high-performance tool that permits clearance in deeper cavities and easier machining against tight walls. Neck relief and short flute length combine to increase end mill stability in the cut. Great for work in pockets.

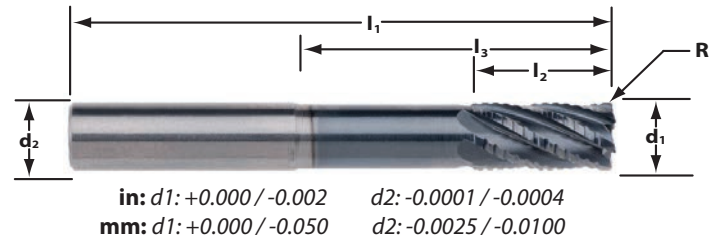

S

Cutter Dia d1	Shank Dia d2	Length of Cut I2	Reach LBS I3	Overall Length I1	Order Code by Corner Radius	
					.015 CR	.030 CR
1/4	1/4	1/2	1-3/8	3	0339388	-
			2-3/8	4	0339390	-
3/8	3/8	3/4	1-3/8	3	-	0339393
			2-3/8	4	-	0339397
1/2	1/2	1	2-1/4	4	-	0339401
			3-1/4	5	-	0339405
5/8	5/8	1-1/4	2-1/8	4	-	0339413
			3-1/8	5	-	0339417
3/4	3/4	1-1/2	2-7/8	5	-	0339421
			3-7/8	6	-	0339425

Cutter Dia d1	Shank Dia d2	Length of Cut I2	Reach LBS I3	Overall Length I1	Order Code by Corner Radius	
					0.5 CR	1.0 CR
6	6	12	39	75	0339435	-
			64	100	0339439	-
8	8	16	39	75	0339443	-
10	10	20	48	88	-	0339451
			60	100	-	0339455
12	12	24	55	100	-	0339459
			80	125	-	0339463
16	16	32	62	110	-	0339471
			102	150	-	0339475
20	20	40	75	125	-	0339479
			100	150	-	0339483

M8 Series Application Guide – Speed & Feed (inch and metric)

ISO Code	Type of Cut	Tool Dia.	Axial Depth	Radial Depth	INCH				METRIC						
					Speed (SFM)	RPM	IPT	IPM	Tool Dia.	Axial Depth	Radial Depth	Speed (M/Min)	RPM	MMPT	MM/Min
S Inconel, Hastalloy, Waspalloy Not recommended for titanium	Rough	1/4	1.25 x D	.2 x D	80	1222	.0008	5.87	6.0	1.25 x D	.2 x D	24.38	1239	.019	141.2
	Slot		0.165	1 x D	80	1222	.00050	3.67		4.15	1 x D	24.38	1239	.0127	94.4
	Rough	5/16	1.25 x D	.2 x D	80	978	.0010	5.87	8.0	1.25 x D	.2 x D	24.38	970	.025	145.5
	Slot		0.205	1 x D	80	978	.00063	3.67		5.20	1 x D	24.38	970	.0160	93.1
	Rough	3/8	1.25 x D	.2 x D	80	815	.0012	5.87	10.0	1.25 x D	.2 x D	24.38	776	.031	144.3
	Slot		0.250	1 x D	80	815	.00075	3.67		6.35	1 x D	24.38	776	.0190	88.5
	Rough	1/2	1.25 x D	.2 x D	80	611	.0016	5.87	12.0	1.25 x D	.2 x D	24.38	647	.037	143.6
	Slot		0.330	1 x D	80	611	.00100	3.67		8.35	1 x D	24.38	647	.0254	98.5
	Rough	5/8	1.25 x D	.2 x D	80	489	.0020	5.87	16.0	1.25 x D	.2 x D	24.38	485	.050	145.5
	Slot		0.415	1 x D	80	489	.00125	3.67		10.50	1 x D	24.38	485	.0317	92.2
	Rough	3/4	1.25 x D	.2 x D	80	407	.0024	5.87	20.0	1.25 x D	.2 x D	24.38	388	.061	142.1
	Slot		0.500	1 x D	80	407	.00150	3.67		12.70	1 x D	24.38	388	.0380	88.4
	Rough	1	1.25 x D	.2 x D	80	306	.0032	5.87	25.0	1.25 x D	.2 x D	24.38	310	.080	148.8
	Slot		0.665	1 x D	80	306	.00200	3.67		16.90	1 x D	24.38	310	.0508	94.4

For using HEM techniques in hi-temp alloys, please reference the POW•R•PATH line of end mills beginning on page 14.

≈	Approximately Equals	<	Less Than
≤	Less Than or Equal To	>	Greater Than
≥	Greater Than or Equal To	=	Equals
x	Multiply		

Common Machining Formulas

$$RPM = \frac{SFM \times 3.82}{D}$$

$$SFM = RPM \times D \times .262$$

$$IPM = RPM \times IPT \times Z$$

$$MRR = RDOC \times ADOC \times IPM$$

$$RPM = \frac{M/min \times 318.3}{D}$$

$$M/min = RPM \times D \times .00314$$

$$MMPM = RPM \times MMPT \times Z$$

$$MRR = RDOC \times ADOC \times MMPM$$

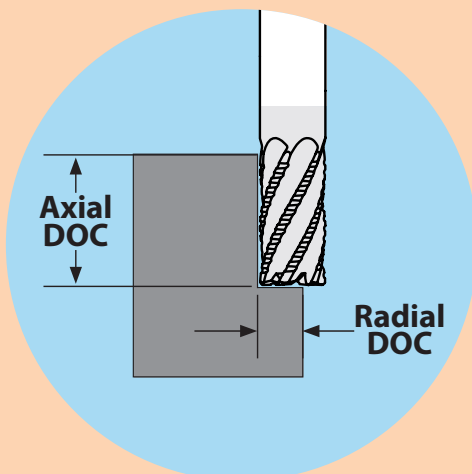

- D** Tool Diameter
- Z** Number of Flutes
- RPM** Revolutions per Minute
- SFM** Surface Feet per Minute
- M/min** Surface Meters per Minute
- IPM** Inches per Minute
- MMPM** Millimeters per Minute
- IPT** Inch per Tooth
- MMPT** Millimeters per Tooth
- MRR** Metal Removal Rate
- RDOC** Radial Depth of Cut
- ADOC** Axial Depth of Cut

Technical Resources

Information on tips and adjustments for the following milling operations can be found in our Technical Resources section beginning on page 134.

- HEM slotting
- Face milling
- Helical entry ramping
- Straight line ramping
- Long tool projection adjustments
- Ball nose milling adjustments
- Other helpful tips and calculations

POW•R•FEED®

THE UNIVERSAL POWERHOUSE.









































Get chatter-free machining, excellent surface finishes and incredible feed rates with POW•R•FEED M9 series end mills. They are beasts at virtually any machining task and material you throw at them.

M9 Series Features

REDEFINING HIGH PERFORMANCE AND VERSATILITY.

The M924, our second-generation POW•R•FEED end mill, is the merging of a 4-flute design with high-performance features and an advanced substrate, creating a tool with the combination of flexibility and output. The reinforced cutting edges, corner radii, variable cutting edge indexing and advanced coating increase metal removal rates and tool life across a wide range of materials.



	M924	M924C	M924N	M904	M905
NUMBER OF FLUTES	 Z4	 Z4	 Z4	 Z4	 Z5
END TYPES	 SQ  CR  BN	 SQ  CR	 CR  BN	 SQ  CR  BN	 SQ  CR
HELIX ANGLE	 38°	 38°	 38°	 38°	 38°
COATING	 AlCrNX	 AlCrNX	 AlCrNX	 AlTiN	 AlTiN
SHANK TYPES	 PLAIN  WELDON	 PLAIN	 PLAIN  NECK	 PLAIN  WELDON	 PLAIN
APPLICATIONS	 ROUGH  FINISH				
MATERIAL(S)	 K  P  M  S				

M924 POW•R•FEED



For high-performance machining in materials ranging from low carbon steels to titanium. The second-generation POW•R•FEED, the M924 design yields enhanced tool life through strengthened cutting edges and corner radii. Very versatile tool — roughing, slotting and finishing — in traditional tool paths in a variety of materials. Great tool in job shops and when used in production runs.

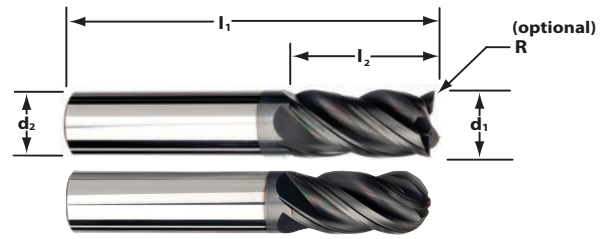

in: $d1: +0.000 / -0.002$ $d2: -0.0001 / -0.0004$
 mm: $d1: +0.000 / -0.050$ $d2: -0.0025 / -0.0100$



Cutter Dia d1	Shank Dia d2	Length of Cut I2	Overall Length I1	Order Code SQ	Order Code by Corner Radius					Order Code BN
					.015 CR	.030 CR	.060 CR	.090 CR	.120 CR	
1/8	1/8	1/4	1-1/2	0338245	0338246	-	-	-	-	-
		1/2	1-1/2	0338247	0338248	-	-	-	-	0338249
		3/4	2-1/4	0338250	0338251	-	-	-	-	-
5/32	3/16	5/16	2	0338273	0338275	-	-	-	-	-
		9/16	2	0338274	0338276	-	-	-	-	0338277
3/16	3/16	5/16	2	0338252	0338253	0338254	-	-	-	-
		9/16	2	0338255	0338256	0338257	-	-	-	0338258
		3/4	2-1/2	0338259	0338260	0338261	-	-	-	-
7/32	1/4	3/8	2	0338278	0338280	-	-	-	-	-
		3/4	2-1/2	0338279	0338281	-	-	-	-	-
1/4	1/4	3/8	2	0338262	0338263	0338264	-	-	-	-
		3/4	2-1/2	0338265	0338266	0338267	0338268	-	-	0338269
		1-1/4	3	0338270	0338271	0338272	-	-	-	-
9/32	5/16	1-3/4	4	0338283	0338284	0338285	-	-	-	-
		3/4	2-1/2	0338286	0338287	0338288	-	-	-	-
5/16	5/16	7/16	2	0338103	0338104	0338105	-	-	-	-
		13/16	2-1/2	0338106	0338107	0338108	0338109	-	-	0338110
		1-1/4	3	0338111	0338112	0338113	-	-	-	-
11/32	3/8	2-1/8	4	0338114	0338115	0338116	-	-	-	-
		7/8	2-1/2	0338289	-	0338290	-	-	-	-
		1/2	2	0338117	0338118	0338119	-	-	-	-
3/8	3/8	7/8	2-1/2	0338120	0338121	0338122	0338123	0338124	-	0338125
		1-1/4	3	0338126	0338127	0338128	0338129	-	-	-
		1-5/8	4	0338130	0338131	0338132	0338133	-	-	-
		2	4	0338134	0338135	0338136	0338137	-	-	-
		2-1/2	5	0338291	0338292	0338293	-	-	-	-
13/32	7/16	1	2-3/4	0338294	-	0338295	-	-	-	
7/16	7/16	5/8	2-1/2	0338138	-	0338139	-	-	-	-
		1	2-3/4	0338140	-	0338141	-	-	-	0338142
		2	4	0338143	-	0338144	-	-	-	-
1/2	1/2	5/8	2-1/2	0338145	-	0338146	0338147	-	-	-
		1	3	0338148	0338149	0338150	0338151	0338152	0338153	0338154
		1-1/4	3	0338155	0338156	0338157	0338158	0338159	0338160	0338161
		1-5/8	4	0338162	-	0338163	0338164	0338165	0338166	-
		2-1/8	4	0338167	-	0338168	0338169	0338170	0338171	-
		2-5/8	5	0338172	-	0338173	0338174	-	-	-
		3-1/4	6	0338175	-	0338176	0338177	-	-	-
		9/16	9/16	1-1/4	3-1/2	0338296	-	0338297	-	-
5/8	5/8	3/4	3	0338178	-	0338179	0338180	-	-	-
		1-3/8	3-1/2	0338181	-	0338182	0338183	-	-	0338186
		2-1/8	4	0338187	-	0338188	0338189	0338190	0338191	-
		2-5/8	5	0338192	-	0338193	0338194	-	-	-
		3-1/4	6	0338195	-	-	-	-	-	-
3/4	3/4	1	3	0338198	-	0338199	0338200	-	-	-
		1-5/8	4	0338201	-	0338202	0338203	0338204	0338205	0338206
		2-3/8	5	0338207	-	0338208	0338209	0338210	0338211	-
		3-1/4	6	0338212	-	0338213	0338214	-	-	-
		4-1/8	7	0338215	-	0338216	0338217	-	-	-
1	1	1-3/4	4	0338218	-	0338219	0338220	-	-	-
		2-1/4	5	0338223	-	0338224	-	-	-	-
		3-1/4	6	0338227	-	0338228	-	-	-	-
		4-1/4	7	0338230	-	0338231	-	-	-	

Cutter Dia d1	Shank Dia d2	Length of Cut l2	Overall Length l1	Order Code SQ	Order Code by Corner Radius								Order Code BN
					0.3 CR	0.5 CR	0.75 CR	1.0 CR	1.5 CR	2.0 CR	3.0 CR	4.0 CR	
3	3	9	38	0338628	-	-	-	-	-	-	-	-	-
		12	38	0338630	0340976	-	-	-	-	-	-	-	0856229
3	6	8	57	0340977	0340980	0855957	-	-	-	-	-	-	0340985
		12	57	0340978	0340979	-	-	-	-	-	-	-	-
3.5	6	10	57	0440706	-	-	-	-	-	-	-	-	
4	6	11	57	0340981	0340982	0855958	-	-	-	-	-	-	0340986
4.5	6	11	57	0855959	-	-	-	-	-	-	-	-	-
5	6	13	57	0340983	0340984	0855960	-	-	-	-	-	-	0340987
6	6	10	54	-	-	0340954	-	-	-	-	-	-	-
		13	57	0338646	0338647	0338648	-	0340955	0340956	-	-	-	0338731
		25	75	0338654	0338655	-	-	-	-	-	-	-	-
8	8	12	58	-	-	0340957	-	-	-	-	-	-	-
		19	63	0338660	-	0338661	-	0340958	0340959	0855961	-	-	0338732
		32	75	0338663	-	0338664	-	-	-	-	-	-	-
10	10	14	66	-	-	0340960	-	-	-	-	-	-	-
		22	72	0338668	-	0338669	-	0338670	0340961	0340962	-	-	0338733
		40	88	0338673	-	0338674	-	-	-	-	-	-	-
12	12	16	73	-	-	-	0340963	-	-	-	-	-	-
		26	83	0338679	-	0338680	0340964	0338681	0340965	0340966	0340967	-	0338734
		50	100	0338684	-	0338685	-	-	-	-	-	-	-
		75	150	0338687	-	0338688	-	-	-	-	-	-	-
14	14	32	83	0338690	-	-	-	0338692	-	-	-	-	
16	16	22	82	-	-	-	-	0340968	-	-	-	-	-
		34	92	0338693	-	0338694	-	0338695	0340969	0340970	0340971	0853639	0338735
		55	110	0338698	-	0338699	-	-	-	-	-	-	-
		75	150	0338701	-	0338702	-	-	-	-	-	-	-
18	18	32	92	0436095	-	-	-	0853642	-	-	-	-	
20	20	26	92	-	-	-	-	0340972	-	-	-	-	-
		38	104	0338704	-	-	-	0338706	0340973	0340974	0340975	0853643	0338736
		65	125	0338714	-	-	-	0853645	-	-	-	-	-
		85	150	0338717	-	-	-	0853648	-	-	-	-	-
25	25	38	104	0856030	-	-	-	0853653	-	-	-	-	-
		52	120	0338720	-	-	-	0853656	-	-	-	-	-
		85	150	0338725	-	-	-	0853657	-	-	-	-	-

Cutter Dia d1	Shank Dia d2	Length of Cut l2	Overall Length l1	Order Code SQ	Order Code by Corner Radius	
					.015 CR	.030 CR
3/8	3/8	7/8	2-1/2	0338885	0338824	0338825
		1-1/4	3	0338886	0338827	0338828
1/2	1/2	1	3	0339036	0339037	0339038
		1-1/4	3	0338891	0338836	0338837
		1-5/8	4	0338892	-	0338840
5/8	5/8	2-1/8	4	0338893	-	0338842
		1-3/8	3-1/2	0338896	-	0338848
		2-1/8	4	0338897	-	0338850
3/4	3/4	1-5/8	4	0338900	-	0338856
		2-3/8	5	0338901	-	0338859
1	1	1-3/4	4	0338904	-	0338866
		2-1/4	5	0338905	-	0338869

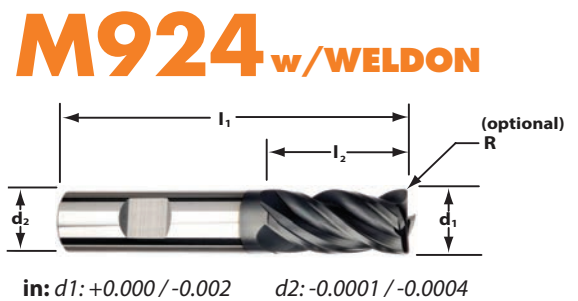

Cutter Dia d1	Shank Dia d2	Length of Cut l2	Overall Length l1	Order Code by Corner Radius					
				0.5 CR	1.0 CR	1.5 CR	2.0 CR	3.0 CR	4.0 CR
10	10	22	72	0853658	0853664	0853671	0853684	-	-
12	12	26	83	0853688	0853691	0853692	0853707	0853709	-
16	16	34	92	0853717	0853718	0853734	0853736	0853744	0853749
20	20	38	104	-	0853751	0853757	0853758	0853763	0853764

M924N POW•R•FEED



For high-performance machining in materials ranging from low carbon steels to titanium. Adding a necked shank to the M924 design offers a high-performance tool that permits clearance in deeper cavities and easier machining against tight walls. Neck relief and short flute length combine to increase end mill stability in the cut for more precise tolerances. Great for work in pockets.

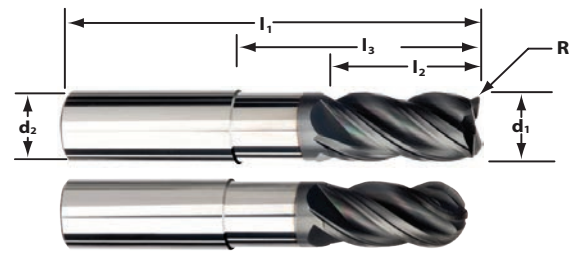

in: d1: +0.000 / -0.002 d2: -0.0001 / -0.0004
mm: d1: +0.000 / -0.050 d2: -0.0025 / -0.0100



Cutter Dia d1	Shank Dia d2	Length of Cut L2	Reach L3	Overall Length L1	Order Code by Corner Radius			Order Code BN
					.015 CR	.030 CR	.060 CR	
1/8	1/8	1/4	1-1/8	2-1/2	0338463	-	-	0338464
3/16	3/16	3/8	1-3/8	3	0338465	0338466	-	0338467
1/4	1/4	1/2	1-3/8	3	0338468	0338469	0338470	0338471
			2-3/8	4	0338472	0338473	0338474	0338475
3/8	3/8	1/2	1-3/8	3	0338476	0338477	0338478	0338480
			2-3/8	4	0338481	0338482	0338483	0338485
			3-3/8	5	0338486	0338487	0338488	0338490
		3/4	2-3/8	4	0338931	0338932	0338933	-
			3-3/8	5	0338934	0338935	0338936	-
			4-3/8	6	0338937	0338938	0338939	-
1/2	1/2	5/8	1-3/8	3	-	0338496	0338497	0338500
			2-1/4	4	-	0338501	0338502	0338505
			3-1/4	5	-	0338506	0338507	0338510
		1	4-1/4	6	-	0338511	0338512	0338515
			2-1/4	4	-	0338586	0338587	-
			3-1/4	5	-	0338589	0338590	-
5/8	5/8	3/4	4-1/4	6	-	0338592	0338593	-
			2-1/8	4	-	0338516	0338517	0338520
			3-1/8	5	-	0338521	0338522	0338525
3/4	3/4	1	4-1/8	6	-	0338526	0338527	0338530
			2	4	-	0338531	0338532	0338535
			2-7/8	5	-	0338536	0338537	0338540
		1-1/2	3-7/8	6	-	0338541	0338542	0338545
			4-7/8	7	-	0338546	0338547	0338550
			2-7/8	5	-	0338604	0338605	-
			3-7/8	6	-	0338607	0338608	-
1	1	1-1/4	4-7/8	7	-	0338610	0338611	-
			2-1/4	4	-	0338551	0338552	0338555
			2-5/8	5	-	0338556	0338557	0338560
			3-5/8	6	-	0338561	0338562	0338565
			4-5/8	7	-	0338566	0338567	0338570

Cutter Dia d1	Shank Dia d2	Length of Cut l2	Reach LBS l3	Overall Length l1	Order Code by Corner Radius			Order Code BN
					0.5 CR	1.0 CR	1.5 CR	
6	6	12	39	75	0338737	-	-	0338806
			64	100	0338738	-	-	0338807
8	8	16	39	75	0338739	-	-	0338808
			64	100	0338740	-	-	0338809
10	10	12	32	72	0338741	0338742	-	0338810
			60	100	0338743	0338744	-	0338811
			110	150	0338745	0338746	-	0338812
12	12	15	38	83	0338747	0338748	0338749	0338813
			55	100	0338750	0338751	0338752	0338814
			80	125	0338753	0338754	0338755	0338815
			105	150	0338756	0338757	0338758	0338816
16	16	20	62	110	0338759	0338760	0338761	0338817
			102	150	0338762	0338763	0338764	0338818
20	20	25	50	100	0338765	0338766	0338767	0338819
			75	125	0338768	0338769	0338770	0338820
			100	150	0338771	0338772	0338773	0338821
25	25	32	64	120	0338774	0338775	0338776	0338822
			94	150	0338777	0338778	0338779	0338823

TOOL TIP

Got LBS? Look For the Neck.

Reducing tool deflection is a key part of successfully milling deep pockets and slots. Using an end mill with a necked-down shank and a stub or standard flute length greatly improves tool stability in long-reach cuts. The necked shank retains much of the core strength of the carbide rod, increasing tool life and achieving more precise milled wall tolerances.

LBS, or Length Below Shank, designates the combined neck length plus the tool's flute length.



M924C POW•R•FEED



For high-performance machining in materials ranging from low carbon steels to titanium. Adds the benefits of the unique **Chip Management System (CMS)** to the versatility of the M924 design. Breaks up long, stringy chips, which eliminates recutting chips and chip packing, and allows for free cutting tool movement.

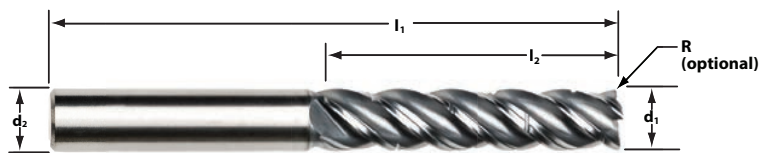

in: $d1: +0.000 / -0.002$ $d2: -0.0001 / -0.0004$
 mm: $d1: +0.000 / -0.050$ $d2: -0.0025 / -0.0100$



Cutter Dia d1	Shank Dia d2	Length of Cut l2	Overall Length l1	Order Code SQ	Order Code by Corner Radius	
					.030 CR	.060 CR
1/2	1/2	2-1/8	4	9164826	9164827	9164828
		2-5/8	5	9164829	9164830	9164831
		3-1/4	6	9164832	9164833	9164834
5/8	5/8	2-1/8	4	9164835	9164836	9164837
		2-5/8	5	9164838	9164839	9164840
		3-1/4	6	9164841	-	-
3/4	3/4	2-3/8	5	9164842	9164843	9164844
		3-1/4	6	9164845	9164846	9164847
		4-1/8	7	9164848	9164849	9164850
1	1	2-1/4	5	9164851	9164852	-
		3-1/4	6	9164853	9164854	-
		4-1/4	7	9164855	9164856	-



M924 Application Guide – Speed & Feed (inch)

ISO Code	Work Material	Type of Cut	Axial DOC	Radial DOC	Number of Flutes	Speed (SFM)	Feed (Inches per Tooth)											
							1/8	5/32	3/16	7/32	1/4	5/16	3/8	7/16	1/2	5/8	3/4	1
K	Cast Iron Gray	Slotting	1 x D	1 x D	4	325	.0006	.0008	.0009	.0011	.0012	.0015	.0018	.0021	.0024	.0030	.0036	.0048
		Peripheral - Rough	1.25 x D	.5 x D	4	400	.0008	.0009	.0011	.0013	.0015	.0019	.0023	.0026	.0030	.0038	.0045	.0060
			Finish	1.5 x D	.015 x D	4	475	.0008	.0010	.0012	.0014	.0017	.0021	.0025	.0029	.0033	.0041	.0050
	Cast Iron Ductile	Slotting	1 x D	1 x D	4	300	.0006	.0007	.0008	.0010	.0011	.0014	.0017	.0019	.0022	.0028	.0033	.0044
		Peripheral - Rough	1.25 x D	.5 x D	4	375	.0007	.0008	.0010	.0012	.0014	.0017	.0020	.0024	.0027	.0034	.0041	.0054
			Finish	1.5 x D	.015 x D	4	450	.0008	.0009	.0011	.0013	.0015	.0019	.0023	.0026	.0030	.0038	.0045
	Cast Iron Malleable	Slotting	.75 x D	1 x D	4	250	.0006	.0007	.0008	.0010	.0011	.0014	.0017	.0019	.0022	.0028	.0033	.0044
		Peripheral - Rough	1.25 x D	.5 x D	4	325	.0007	.0008	.0010	.0012	.0014	.0017	.0020	.0024	.0027	.0034	.0041	.0054
			Finish	1.5 x D	.015 x D	4	400	.0008	.0009	.0011	.0013	.0015	.0019	.0023	.0026	.0030	.0038	.0045
P	Low Carbon Steels 1018, 12L14, 8620	Slotting	1 x D	1 x D	4	350	.0007	.0008	.0010	.0011	.0013	.0016	.0020	.0023	.0026	.0033	.0039	.0052
		Peripheral - Rough	1.25 x D	.5 x D	4	425	.0008	.0010	.0012	.0014	.0016	.0020	.0024	.0028	.0032	.0040	.0048	.0064
			Finish	1.5 x D	.015 x D	4	500	.0009	.0011	.0014	.0016	.0018	.0023	.0027	.0032	.0036	.0045	.0054
	Medium Carbon Steels 4140, 4340	Slotting	1 x D	1 x D	4	300	.0006	.0008	.0009	.0011	.0012	.0015	.0018	.0021	.0024	.0030	.0036	.0048
		Peripheral - Rough	1.25 x D	.5 x D	4	375	.0008	.0009	.0011	.0013	.0015	.0019	.0023	.0026	.0030	.0038	.0045	.0060
			Finish	1.5 x D	.015 x D	4	450	.0008	.0010	.0012	.0014	.0017	.0021	.0025	.0029	.0033	.0041	.0050
	Tool & Die Steels <48 Rc A2, D2, H13, P20	Slotting	.75 x D	1 x D	4	300	.0006	.0008	.0009	.0011	.0012	.0015	.0018	.0021	.0024	.0030	.0036	.0048
		Peripheral - Rough	1.25 x D	.3 x D	4	375	.0007	.0009	.0011	.0013	.0015	.0018	.0022	.0025	.0029	.0036	.0044	.0058
			Finish	1.5 x D	.015 x D	4	450	.0008	.0009	.0011	.0013	.0015	.0019	.0023	.0026	.0030	.0038	.0045
M	Martensitic Stainless Steels 416, 410, 440C	Slotting	.75 x D	1 x D	4	300	.0006	.0008	.0009	.0011	.0012	.0015	.0018	.0021	.0024	.0030	.0036	.0048
		Peripheral - Rough	1.25 x D	.3 x D	4	375	.0007	.0009	.0011	.0013	.0015	.0018	.0022	.0025	.0029	.0036	.0044	.0058
			Finish	1.5 x D	.015 x D	4	450	.0008	.0009	.0011	.0013	.0015	.0019	.0023	.0026	.0030	.0038	.0045
	Austenitic Stainless Steels 303, 304, 316	Slotting	.75 x D	1 x D	4	275	.0007	.0008	.0010	.0011	.0013	.0016	.0020	.0023	.0026	.0033	.0039	.0052
		Peripheral - Rough	1.25 x D	.3 x D	4	325	.0008	.0010	.0012	.0014	.0016	.0020	.0024	.0028	.0032	.0040	.0048	.0064
			Finish	1.5 x D	.015 x D	4	400	.0008	.0010	.0012	.0014	.0017	.0021	.0025	.0029	.0033	.0041	.0050
	Precipitation Hardening Stainless Steels 17-4, 15-5, 13-8	Slotting	.5 x D	1 x D	4	250	.0005	.0006	.0008	.0009	.0010	.0013	.0015	.0018	.0020	.0025	.0030	.0040
		Peripheral - Rough	1.25 x D	.3 x D	4	300	.0006	.0008	.0009	.0011	.0013	.0016	.0019	.0022	.0025	.0031	.0038	.0050
			Finish	1.5 x D	.015 x D	4	375	.0007	.0008	.0010	.0011	.0013	.0016	.0020	.0023	.0026	.0033	.0039
S	Titanium Alloys 6AL - 4V	Slotting	.5 x D	1 x D	4	250	.0005	.0006	.0008	.0009	.0010	.0013	.0015	.0018	.0020	.0025	.0030	.0040
		Peripheral - Rough	1.25 x D	.3 x D	4	300	.0006	.0008	.0009	.0011	.0013	.0016	.0019	.0022	.0025	.0031	.0038	.0050
			Finish	1.5 x D	.015 x D	4	375	.0007	.0008	.0010	.0011	.0013	.0016	.0020	.0023	.0026	.0033	.0039
	High Temperature Alloys Inconel, Haynes, Stellite, Hastalloy	Slotting	.25 x D	1 x D	4	60	.0005	.0007	.0008	.0009	.0011	.0013	.0016	.0018	.0021	.0026	.0032	.0042
		Peripheral - Rough	1.25 x D	.25 x D	4	90	.0007	.0008	.0010	.0012	.0014	.0017	.0020	.0024	.0027	.0034	.0041	.0054
			Finish	1.5 x D	.01 x D	4	125	.0008	.0010	.0012	.0014	.0016	.0019	.0023	.0027	.0031	.0039	.0047

D = Tool Diameter

≈ Approximately Equals < Less Than
 ≤ Less Than or Equal To > Greater Than
 ≥ Greater Than or Equal To = Equals
 × Multiply

Common Machining Formulas

$$RPM = \frac{SFM \times 3.82}{D}$$

$$SFM = RPM \times D \times .262$$

$$IPM = RPM \times IPT \times Z$$

$$MRR = RDOC \times ADOC \times IPM$$

$$RPM = \frac{M/min \times 318.3}{D}$$

$$M/min = RPM \times D \times .00314$$

$$MMPM = RPM \times MMPT \times Z$$

$$MRR = RDOC \times ADOC \times MMPM$$

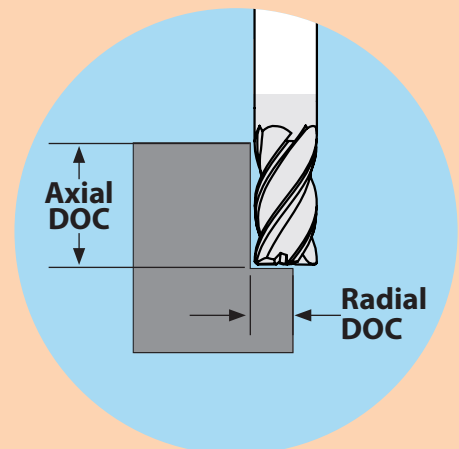

M924 Application Guide – Speed & Feed (metric)

ISO Code	Work Material	Type of Cut	Axial DOC	Radial DOC	Number of Flutes	Speed (M/min)	Feed (MM per Tooth)										
							3.0	4.0	5.0	6.0	8.0	10.0	12.0	14.0	16.0	20.0	25.0
K	Cast Iron Gray	Slotting	1 x D	1 x D	4	99	.0144	.0192	.0240	.0288	.0384	.0478	.0576	.0672	.0766	.0956	.1198
		Peripheral - Rough	1.25 x D	.5 x D	4	122	.0180	.0240	.0300	.0360	.0480	.0598	.0720	.0840	.0958	.1195	.1497
			Finish	1.5 x D	.015 x D	4	145	.0198	.0264	.0330	.0396	.0528	.0657	.0792	.0924	.1053	.1315
	Cast Iron Ductile	Slotting	1 x D	1 x D	4	91	.0132	.0176	.0220	.0264	.0352	.0438	.0528	.0616	.0702	.0876	.1098
		Peripheral - Rough	1.25 x D	.5 x D	4	114	.0162	.0216	.0270	.0324	.0432	.0538	.0648	.0756	.0862	.1076	.1348
			Finish	1.5 x D	.015 x D	4	137	.0180	.0240	.0300	.0360	.0480	.0598	.0720	.0840	.0958	.1195
	Cast Iron Malleable	Slotting	.75 x D	1 x D	4	76	.0132	.0176	.0220	.0264	.0352	.0438	.0528	.0616	.0702	.0876	.1098
		Peripheral - Rough	1.25 x D	.5 x D	4	99	.0162	.0216	.0270	.0324	.0432	.0538	.0648	.0756	.0862	.1076	.1348
			Finish	1.5 x D	.015 x D	4	122	.0180	.0240	.0300	.0360	.0480	.0598	.0720	.0840	.0958	.1195
P	Low Carbon Steels 1018, 12L14, 8620	Slotting	1 x D	1 x D	4	107	.0156	.0208	.0260	.0312	.0416	.0518	.0624	.0728	.0830	.1036	.1298
		Peripheral - Rough	1.25 x D	.5 x D	4	130	.0192	.0256	.0320	.0384	.0512	.0637	.0768	.0896	.1021	.1275	.1597
			Finish	1.5 x D	.015 x D	4	152	.0216	.0288	.0360	.0432	.0576	.0717	.0864	.1008	.1149	.1434
	Medium Carbon Steels 4140, 4340	Slotting	1 x D	1 x D	4	91	.0144	.0192	.0240	.0288	.0384	.0478	.0576	.0672	.0766	.0956	.1198
		Peripheral - Rough	1.25 x D	.5 x D	4	114	.0180	.0240	.0300	.0360	.0480	.0598	.0720	.0840	.0958	.1195	.1497
			Finish	1.5 x D	.015 x D	4	137	.0198	.0264	.0330	.0396	.0528	.0657	.0792	.0924	.1053	.1315
	Tool & Die Steels <48 Rc A2, D2, H13, P20	Slotting	.75 x D	1 x D	4	91	.0144	.0192	.0240	.0288	.0384	.0478	.0576	.0672	.0766	.0956	.1198
		Peripheral - Rough	1.25 x D	.3 x D	4	114	.0174	.0232	.0290	.0348	.0464	.0578	.0696	.0812	.0926	.1155	.1448
			Finish	1.5 x D	.015 x D	4	137	.0180	.0240	.0300	.0360	.0480	.0598	.0720	.0840	.0958	.1195
M	Martensitic Stainless Steels 416, 410, 440C	Slotting	.75 x D	1 x D	4	91	.0144	.0192	.0240	.0288	.0384	.0478	.0576	.0672	.0766	.0956	.1198
		Peripheral - Rough	1.25 x D	.3 x D	4	114	.0174	.0232	.0290	.0348	.0464	.0578	.0696	.0812	.0926	.1155	.1448
			Finish	1.5 x D	.015 x D	4	137	.0180	.0240	.0300	.0360	.0480	.0598	.0720	.0840	.0958	.1195
	Austenitic Stainless Steels 303, 304, 316	Slotting	.75 x D	1 x D	4	84	.0156	.0208	.0260	.0312	.0416	.0518	.0624	.0728	.0830	.1036	.1298
		Peripheral - Rough	1.25 x D	.3 x D	4	99	.0192	.0256	.0320	.0384	.0512	.0637	.0768	.0896	.1021	.1275	.1597
			Finish	1.5 x D	.015 x D	4	122	.0198	.0264	.0330	.0396	.0528	.0657	.0792	.0924	.1053	.1315
	Precipitation Hardening Stainless Steels 17-4, 15-5, 13-8	Slotting	.5 x D	1 x D	4	76	.0120	.0160	.0200	.0240	.0320	.0398	.0480	.0560	.0638	.0797	.0998
		Peripheral - Rough	1.25 x D	.3 x D	4	91	.0150	.0200	.0250	.0300	.0400	.0498	.0600	.0700	.0798	.0996	.1248
			Finish	1.5 x D	.015 x D	4	114	.0156	.0208	.0260	.0312	.0416	.0518	.0624	.0728	.0830	.1036
S	Titanium Alloys 6AL-4V	Slotting	.5 x D	1 x D	4	76	.0120	.0160	.0200	.0240	.0320	.0398	.0480	.0560	.0638	.0797	.0998
		Peripheral - Rough	1.25 x D	.3 x D	4	91	.0150	.0200	.0250	.0300	.0400	.0498	.0600	.0700	.0798	.0996	.1248
			Finish	1.5 x D	.015 x D	4	114	.0156	.0208	.0260	.0312	.0416	.0518	.0624	.0728	.0830	.1036
	High Temperature Alloys Inconel, Haynes, Stellite, Hastalloy	Slotting	.25 x D	1 x D	4	18	.0126	.0168	.0210	.0252	.0336	.0418	.0504	.0588	.0670	.0837	.1048
		Peripheral - Rough	1.25 x D	.25 x D	4	27	.0162	.0216	.0270	.0324	.0432	.0538	.0648	.0756	.0862	.1076	.1348
			Finish	1.5 x D	.01 x D	4	38	.0186	.0248	.0310	.0372	.0496	.0617	.0744	.0868	.0989	.1235

D = Tool Diameter

- D** Tool Diameter
- Z** Number of Flutes
- RPM** Revolutions per Minute
- SFM** Surface Feet per Minute
- M/min** Surface Meters per Minute
- IPM** Inches per Minute
- MMPM** Millimeters per Minute
- IPT** Inch per Tooth
- MMPT** Millimeters per Tooth
- MRR** Metal Removal Rate
- RDOC** Radial Depth of Cut
- ADOC** Axial Depth of Cut

Technical Resources

Information on tips and adjustments for the following milling operations can be found in our Technical Resources section beginning on page 134.

- HEM slotting
- Face milling
- Helical entry ramping
- Straight line ramping
- Long tool projection adjustments
- Ball nose milling adjustments
- Other helpful tips and calculations

M904 POW•R•FEED



For high-performance machining in materials ranging from low carbon steels to titanium. Our first-generation POW•R•FEED design, the M904 offers improved tool life and feed rates over general-purpose end mills by utilizing variable cutting edge indexing and advanced coating technology.

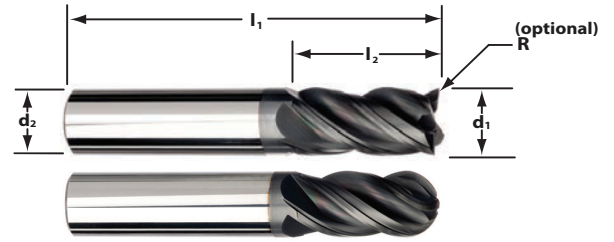

in: $d1: +0.000 / -0.002$ $d2: -0.0001 / -0.0004$



Cutter Dia d1	Shank Dia d2	Length of Cut I2	Overall Length I1	Order Code SQ	Order Code by Corner Radius					Order Code BN
					.015 CR	.020 CR	.030 CR	.060 CR	.125 CR	
1/8	1/8	1/4	1-1/2	-	0335668	-	-	-	-	-
		1/2	1-1/2	0335526	0335564	-	-	-	-	0335613
5/32	3/16	9/16	2	0335527	0335605	-	-	-	-	-
		3/16	2	-	0335669	-	-	-	-	-
3/16	3/16	5/16	2	-	0335669	-	-	-	-	-
		5/8	2	0335528	0335565	-	-	-	-	0335615
7/32	1/4	5/8	2-1/2	0335529	-	0335606	-	-	-	-
		3/8	2	0335521	-	0335559	-	-	-	-
1/4	1/4	3/4	2-1/2	0335530	-	0335566	0335801	-	-	0335617
		1-1/8	3	-	-	0335774	-	-	-	-
		1-1/2	4	-	-	0335779	-	-	-	-
5/16	5/16	13/16	2-1/2	0335531	-	0335567	-	-	-	-
		1/2	2	0335522	-	0335560	-	-	-	-
3/8	3/8	7/8	2-1/2	0335532	-	0335568	0335756	-	-	0335619
		1-1/8	3	-	-	0335775	-	-	-	-
		1-3/4	4	-	-	0335780	-	-	-	-
7/16	7/16	1	2-3/4	0335533	-	0335569	-	-	-	-
		5/8	2-1/2	0335523	-	-	0335561	-	-	-
1/2	1/2	1	3	0335534	-	-	0335570	-	-	0335621
		1-1/4	3	0335594	-	-	0335592	0335757	0335759	0335622
		2	4	-	-	-	0335776	-	-	-
		2-1/2	5	-	-	-	0335781	-	-	-
5/8	5/8	1-1/4	3-1/2	0335535	-	-	0335571	-	-	-
		1-1/2	4	0335536	-	-	0335572	0335761	0335763	0335624
3/4	3/4	2-1/4	5	-	-	-	0335777	-	-	-
		3	6	-	-	-	0335782	-	-	-
		1-1/2	4	0335537	-	-	0335573	-	-	-
1	1	3	6	-	-	-	0335783	-	-	-
		4-1/8	7	-	-	-	0335786	-	-	-

Cutter Dia d1	Shank Dia d2	Length of Cut I2	Overall Length I1	Order Code SQ	Order Code by Corner Radius				Order Code BN
					.020 CR	.030 CR	.060 CR	.125 CR	
3/8	3/8	7/8	2-1/2	0335547	0335580	0335765	-	-	0335635
		1	3	0335549	-	0335582	-	-	0335637
1/2	1/2	1-1/4	3	0335595	-	0335593	0335766	0335768	0335638
		5/8	3-1/2	0335550	-	0335583	-	-	-
3/4	3/4	1-1/2	4	0335551	-	0335584	0335770	0335772	-

M904 w/WELDON

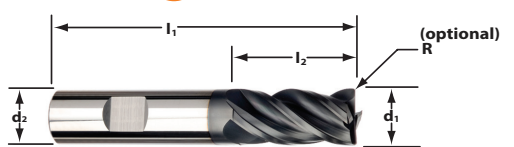

in: $d1: +0.000 / -0.002$ $d2: -0.0001 / -0.0004$

M904 Application Guide – Speed & Feed (inch)

ISO Code	Work Material	Type of Cut	Axial DOC	Radial DOC	Number of Flutes	Speed (SFM)	Feed (Inches per Tooth)											
							1/8	5/32	3/16	7/32	1/4	5/16	3/8	7/16	1/2	5/8	3/4	1
K	Cast Iron Gray	Slotting	1 x D	1 x D	4	325	.0006	.0008	.0009	.0011	.0012	.0015	.0018	.0021	.0024	.0030	.0036	.0048
		Peripheral - Rough	1.25 x D	.5 x D	4	400	.0008	.0009	.0011	.0013	.0015	.0019	.0023	.0026	.0030	.0038	.0045	.0060
		Finish	1.5 x D	.015 x D	4	475	.0008	.0010	.0012	.0014	.0017	.0021	.0025	.0029	.0033	.0041	.0050	.0066
	Cast Iron Ductile	Slotting	1 x D	1 x D	4	300	.0006	.0007	.0008	.0010	.0011	.0014	.0017	.0019	.0022	.0028	.0033	.0044
		Peripheral - Rough	1.25 x D	.5 x D	4	375	.0007	.0008	.0010	.0012	.0014	.0017	.0020	.0024	.0027	.0034	.0041	.0054
		Finish	1.5 x D	.015 x D	4	450	.0008	.0009	.0011	.0013	.0015	.0019	.0023	.0026	.0030	.0038	.0045	.0060
Cast Iron Malleable	Slotting	.75 x D	1 x D	4	250	.0006	.0007	.0008	.0010	.0011	.0014	.0017	.0019	.0022	.0028	.0033	.0044	
	Peripheral - Rough	1.25 x D	.5 x D	4	325	.0007	.0008	.0010	.0012	.0014	.0017	.0020	.0024	.0027	.0034	.0041	.0054	
	Finish	1.5 x D	.015 x D	4	400	.0008	.0009	.0011	.0013	.0015	.0019	.0023	.0026	.0030	.0038	.0045	.0060	
P	Low Carbon Steels 1018, 12L14, 8620	Slotting	1 x D	1 x D	4	350	.0007	.0008	.0010	.0011	.0013	.0016	.0020	.0023	.0026	.0033	.0039	.0052
		Peripheral - Rough	1.25 x D	.5 x D	4	425	.0008	.0010	.0012	.0014	.0016	.0020	.0024	.0028	.0032	.0040	.0048	.0064
		Finish	1.5 x D	.015 x D	4	500	.0009	.0011	.0014	.0016	.0018	.0023	.0027	.0032	.0036	.0045	.0054	.0072
	Medium Carbon Steels 4140, 4340	Slotting	1 x D	1 x D	4	300	.0006	.0008	.0009	.0011	.0012	.0015	.0018	.0021	.0024	.0030	.0036	.0048
		Peripheral - Rough	1.25 x D	.5 x D	4	375	.0008	.0009	.0011	.0013	.0015	.0019	.0023	.0026	.0030	.0038	.0045	.0060
		Finish	1.5 x D	.015 x D	4	450	.0008	.0010	.0012	.0014	.0017	.0021	.0025	.0029	.0033	.0041	.0050	.0066
Tool & Die Steels <48 Rc A2, D2, H13, P20	Slotting	.75 x D	1 x D	4	300	.0006	.0008	.0009	.0011	.0012	.0015	.0018	.0021	.0024	.0030	.0036	.0048	
	Peripheral - Rough	1.25 x D	.3 x D	4	375	.0007	.0009	.0011	.0013	.0015	.0018	.0022	.0025	.0029	.0036	.0044	.0058	
	Finish	1.5 x D	.015 x D	4	450	.0008	.0009	.0011	.0013	.0015	.0019	.0023	.0026	.0030	.0038	.0045	.0060	
M	Martensitic Stainless Steels 416, 410, 440C	Slotting	.75 x D	1 x D	4	300	.0006	.0008	.0009	.0011	.0012	.0015	.0018	.0021	.0024	.0030	.0036	.0048
		Peripheral - Rough	1.25 x D	.3 x D	4	375	.0007	.0009	.0011	.0013	.0015	.0018	.0022	.0025	.0029	.0036	.0044	.0058
		Finish	1.5 x D	.015 x D	4	450	.0008	.0009	.0011	.0013	.0015	.0019	.0023	.0026	.0030	.0038	.0045	.0060
	Austenitic Stainless Steels 303, 304, 316	Slotting	.75 x D	1 x D	4	275	.0007	.0008	.0010	.0011	.0013	.0016	.0020	.0023	.0026	.0033	.0039	.0052
		Peripheral - Rough	1.25 x D	.3 x D	4	325	.0008	.0010	.0012	.0014	.0016	.0020	.0024	.0028	.0032	.0040	.0048	.0064
		Finish	1.5 x D	.015 x D	4	400	.0008	.0010	.0012	.0014	.0017	.0021	.0025	.0029	.0033	.0041	.0050	.0066
Precipitation Hardening Stainless Steel 17-4, 15-5	Slotting	.5 x D	1 x D	4	250	.0005	.0006	.0008	.0009	.0010	.0013	.0015	.0018	.0020	.0025	.0030	.0040	
	Peripheral - Rough	1.25 x D	.3 x D	4	300	.0006	.0008	.0009	.0011	.0013	.0016	.0019	.0022	.0025	.0031	.0038	.0050	
S	Titanium Alloys 6AL - 4V	Slotting	.5 x D	1 x D	4	250	.0005	.0006	.0008	.0009	.0010	.0013	.0015	.0018	.0020	.0025	.0030	.0040
		Peripheral - Rough	1.25 x D	.3 x D	4	300	.0006	.0008	.0009	.0011	.0013	.0016	.0019	.0022	.0025	.0031	.0038	.0050
		Finish	1.5 x D	.015 x D	4	375	.0007	.0008	.0010	.0011	.0013	.0016	.0020	.0023	.0026	.0033	.0039	.0052
	High Temperature Alloys Inconel, Haynes, Stellite, Hastalloy	Slotting	.25 x D	1 x D	4	60	.0005	.0007	.0008	.0009	.0011	.0013	.0016	.0018	.0021	.0026	.0032	.0042
		Peripheral - Rough	1.25 x D	.25 x D	4	90	.0007	.0008	.0010	.0012	.0014	.0017	.0020	.0024	.0027	.0034	.0041	.0054
		Finish	1.5 x D	.01 x D	4	125	.0008	.0010	.0012	.0014	.0016	.0019	.0023	.0027	.0031	.0039	.0047	.0062

D = Tool Diameter

≈ Approximately Equals < Less Than
 ≤ Less Than or Equal To > Greater Than
 ≥ Greater Than or Equal To = Equals
 × Multiply

Common Machining Formulas

$$RPM = \frac{SFM \times 3.82}{D}$$

$$SFM = RPM \times D \times .262$$

$$IPM = RPM \times IPT \times Z$$

$$MRR = RDOC \times ADOC \times IPM$$

D Tool Diameter
Z Number of Flutes
RPM Revolutions per Minute
SFM Surface Feet per Minute
IPM Inches per Minute
IPT Inch per Tooth
MRR Metal Removal Rate
RDOC Radial Depth of Cut
ADOC Axial Depth of Cut

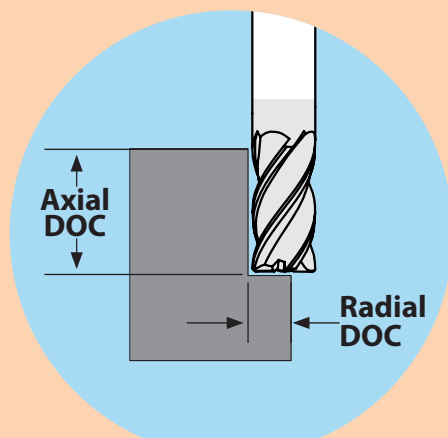

Tool Tech Support

Information on tips and adjustments for the following milling operations can be found in our Technical Resources section beginning on page 134.

- HEM slotting
- Face milling
- Helical entry ramping
- Straight line ramping
- Long tool projection adjustments
- Ball nose milling adjustments
- Other helpful tips and calculations

M905 POW•R•FEED



For high-performance machining in materials ranging from low carbon steels to titanium. The 5-flute version of our first-generation POW•R•FEED design, the M905 offers improved tool life and feed rates over general-purpose end mills by utilizing variable cutting edge indexing and advanced coating technology.

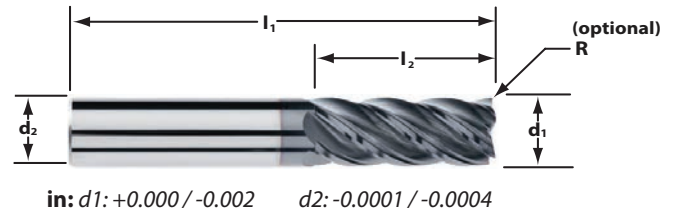

Cutter Dia d1	Shank Dia d2	Length of Cut I2	Overall Length I1	Order Code SQ	Order Code by Corner Radius		
					.020 CR	.030 CR	.060 CR
1/4	1/4	3/4	2-1/2	0335721	0335694	0335800	-
3/8	3/8	7/8	2-1/2	0335722	0335695	0335738	-
1/2	1/2	1-1/4	3	0335723	-	0335696	0335739
5/8	5/8	1-1/4	3-1/2	0335724	-	0335697	0335742
3/4	3/4	1-1/2	4	0335725	-	0335698	0335743

M905 Application Guide – Speed & Feed (inch)

ISO Code	Work Material	Type of Cut	Axial DOC	Radial DOC	No. of Flutes	Speed (SFM)	Feed (Inches per Tooth)				
							1/4	3/8	1/2	5/8	3/4
K	Cast Iron Gray	Slotting	.5 x D	1 x D	5	350	.0011	.0016	.0022	.0027	.0032
		Peripheral - Rough	1.25 x D	.3 x D	5	450	.0014	.0020	.0027	.0034	.0041
		Finish	1.5 x D	.01 x D	5	450	.0018	.0027	.0037	.0046	.0055
	Cast Iron Malleable	Slotting	.5 x D	1 x D	5	300	.0010	.0014	.0019	.0024	.0029
		Peripheral - Rough	1.25 x D	.3 x D	5	375	.0012	.0018	.0024	.0030	.0036
		Finish	1.5 x D	.01 x D	5	450	.0016	.0024	.0033	.0041	.0049
P	Low Carbon Steels 1018, 12L14, 8620	Slotting	.5 x D	1 x D	5	350	.0012	.0017	.0023	.0029	.0035
		Peripheral - Rough	1.25 x D	.3 x D	5	425	.0015	.0022	.0029	.0036	.0044
		Finish	1.5 x D	.01 x D	5	500	.0020	.0030	.0039	.0049	.0059
	Medium Carbon Steels 4140, 4340	Slotting	.5 x D	1 x D	5	300	.0011	.0016	.0022	.0027	.0032
		Peripheral - Rough	1.25 x D	.3 x D	5	375	.0014	.0020	.0027	.0034	.0041
		Finish	1.5 x D	.01 x D	5	450	.0018	.0027	.0037	.0046	.0055
	Tool & Die Steels < 48 Rc A2, D2, H13, P20	Slotting	.5 x D	1 x D	5	300	.0010	.0016	.0021	.0026	.0031
		Peripheral - Rough	1.25 x D	.3 x D	5	375	.0013	.0020	.0026	.0033	.0039
		Finish	1.5 x D	.01 x D	5	450	.0016	.0024	.0033	.0041	.0049
M	Martensitic Stainless Steels 416, 410, 440C	Slotting	.5 x D	1 x D	5	300	.0010	.0016	.0021	.0026	.0031
		Peripheral - Rough	1.25 x D	.3 x D	5	375	.0013	.0020	.0026	.0033	.0039
		Finish	1.5 x D	.01 x D	5	450	.0016	.0024	.0033	.0041	.0049
	Austenitic Stainless Steels 303, 304, 316	Slotting	.5 x D	1 x D	5	275	.0012	.0018	.0024	.0029	.0035
		Peripheral - Rough	1.25 x D	.3 x D	5	325	.0015	.0022	.0029	.0037	.0044
		Finish	1.5 x D	.01 x D	5	400	.0018	.0027	.0037	.0046	.0055
	Precipitation Hardening Stainless Steels 17-4 PH, 15-5 PH, 13-8 PH	Slotting	.5 x D	1 x D	5	250	.0008	.0012	.0017	.0021	.0025
		Peripheral - Rough	1.25 x D	.3 x D	5	300	.0010	.0016	.0021	.0026	.0031
		Finish	1.5 x D	.01 x D	5	375	.0013	.0019	.0026	.0032	.0039
S	Titanium Alloys	Slotting	.5 x D	1 x D	5	250	.0009	.0013	.0017	.0022	.0026
		Peripheral - Rough	1.25 x D	.3 x D	5	300	.0011	.0016	.0022	.0027	.0033
		Finish	1.5 x D	.01 x D	5	375	.0014	.0020	.0027	.0034	.0041

D = Tool Diameter

Information on tips and adjustments can be found in our Technical Resources section beginning on page 134.

Common Machining Formulas

$$RPM = \frac{SFM \times 3.82}{D}$$

$$SFM = RPM \times D \times .262$$

$$IPM = RPM \times IPT \times Z$$

$$MRR = RDOC \times ADOC \times IPM$$

$$RPM = \frac{M/min \times 318.3}{D}$$

$$M/min = RPM \times D \times .00314$$

$$MMPM = RPM \times MMPT \times Z$$

$$MRR = RDOC \times ADOC \times MMPM$$

- D Tool Diameter
- Z Number of Flutes
- RPM Revolutions per Minute
- SFM Surface Feet per Minute
- IPM Inches per Minute
- IPT Inch per Tooth
- MRR Metal Removal Rate
- RDOC Radial Depth of Cut
- ADOC Axial Depth of Cut

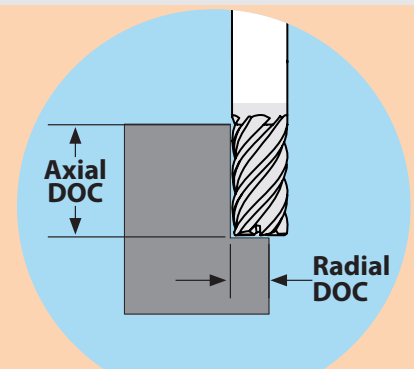



STREAKERS[®]

SHEAR IT AND CLEAR IT.

IMCO's unique design makes STREAKERS end mills first-rate roughers and excellent finishers. Get high metal removal rates without maxing out horsepower.



M2 Series Features

WON'T GUM UP THE WORKS.

Introducing the brand new member of the STREAKERS family – the M213 end mills. Designed specifically for the extreme tool paths often used in the high performance machining of aluminum alloys, the M213 STREAKERS create a free cutting action for more aggressive moves such as plunging without using a peck cycle and ramping at high feed rates on entry moves. Add these amazing benefits to the already incredible line up of legacy STREAKERS for the most complete family of high-performance aluminum end mills.

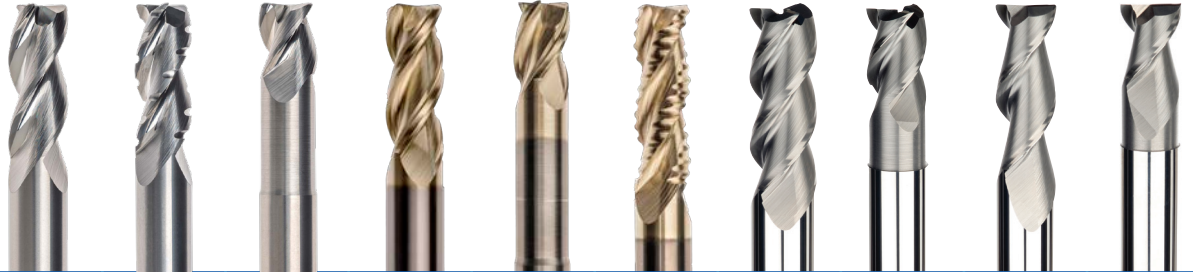

	M213	M213C	M213N	M223	M223N	M233	M203	M203N	M202	M202N
NUMBER OF FLUTES	Z3	Z3	Z3	Z3	Z3	Z3	Z3	Z3	Z2	Z2
END TYPES	SQ	SQ	SQ	SQ	SQ	CR	SQ	SQ	SQ	SQ
	CR	CR	CR	CR	CR		CR		CR	
	BN		BN	BN	BN				BN	
HELIX ANGLE	37°	37°	37°	37°	37°	37°	45°	45°	45°	45°
COATING	HIGH POLISH	HIGH POLISH	HIGH POLISH	ZrN	ZrN	ZrN	NONE	NONE	NONE	NONE
SHANK TYPES	PLAIN	PLAIN	PLAIN	PLAIN	PLAIN	PLAIN	PLAIN	PLAIN	PLAIN	PLAIN
			NECK	WELDON	NECK		WELDON	NECK	WELDON	NECK
APPLICATIONS			ROUGH	FINISH			ROUGH	ROUGH	FINISH	ROUGH
MATERIAL(S)										

M213 STREAKERS



For high-performance machining in aluminum alloys. Designed to handle extreme tool paths in aluminum alloys – the NEW STREAKERS M213 end mills provide superior surface finishes and are engineered to meet the demands of today’s aerospace industry.

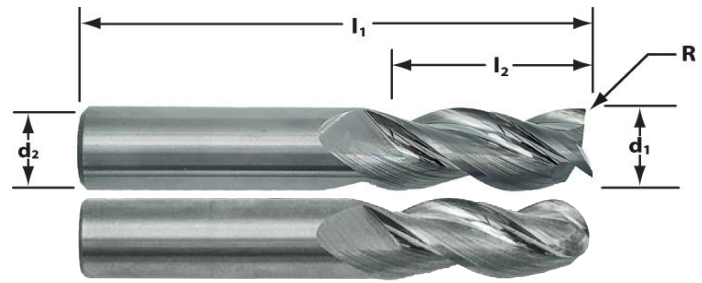

in: $d1: -0.0001 / -0.0004$ $d2: -0.0001 / -0.0004$
 cr/ball nose: ± 0.0015

Cutter Dia d1	Shank Dia d2	Length of Cut I2	Overall Length I1	Order Code SQ	Order Code by Corner Radius							Order Code BN
					.015 CR	.030 CR	.060 CR	.090 CR	.125 CR	.187 CR	.250 CR	
1/8	1/8	3/16	1-1/2	9163464	-	-	-	-	-	-	-	-
		1/4	1-1/2	9163465	9163466	-	-	-	-	-	-	-
		1/4	2	9163467	-	-	-	-	-	-	-	-
		3/8	1-1/2	9163468	9163469	-	-	-	-	-	-	9163658
		3/8	2	9163470	9163471	-	-	-	-	-	-	9163659
		1/2	2	9163472	-	-	-	-	-	-	-	9163660
		5/8	2	9163473	-	-	-	-	-	-	-	-
		3/4	2	9163474	-	-	-	-	-	-	-	-
3/16	3/16	1/4	2	9163476	9163676	9163677	-	-	-	-	-	-
		3/8	2	9163477	-	-	-	-	-	-	-	9163661
		1/2	2	9163478	9163479	9163480	-	-	-	-	-	-
		5/8	2-1/2	9163481	9163482	9163483	-	-	-	-	-	9163662
		3/4	2-1/2	9163484	-	-	-	-	-	-	-	-
		1	2-1/2	9163485	-	-	-	-	-	-	-	-
1/4	1/4	3/8	2	9163486	9163487	9163488	-	-	-	-	-	-
		3/8	2-1/2	9163489	9163490	9163491	-	-	-	-	-	-
		1/2	2-1/2	9163492	-	-	-	-	-	-	-	9163663
		5/8	2-1/2	9163493	9163494	9163495	9163496	-	-	-	-	-
		3/4	2-1/2	9163497	9163498	9163499	9163500	-	-	-	-	9163664
		1	3	9163501	9163502	9163503	-	-	-	-	-	-
		1-1/4	3	9163504	-	9163505	-	-	-	-	-	-
		1-1/2	3	9163506	-	-	-	-	-	-	-	-
		1-3/4	4	9163507	-	-	-	-	-	-	-	-
5/16	5/16	2	4	9163508	-	-	-	-	-	-	-	-
		5/8	2-1/2	9163509	-	-	-	-	-	-	-	-
		13/16	2-1/2	9163510	9163511	9163512	-	-	-	-	-	9163665
		15/16	2-1/2	9163513	-	-	-	-	-	-	-	-
		1-1/4	3	9163514	-	-	-	-	-	-	-	-
3/8	3/8	1-1/2	4	9163515	-	-	-	-	-	-	-	-
		1/2	2	9163516	9163517	9163518	-	-	-	-	-	-
		1/2	2-1/2	9163519	9163520	9163521	-	-	-	-	-	-
		5/8	2-1/2	9163522	9163523	9163524	9163678	9163680	-	-	-	9163666
		3/4	2-1/2	9163525	-	-	-	-	-	-	-	

Cutter Dia d1	Shank Dia d2	Length of Cut l2	Overall Length l1	Order Code SQ	Order Code by Corner Radius							Order Code BN
					.015 CR	.030 CR	.060 CR	.090 CR	.125 CR	.187 CR	.250 CR	
3/8	3/8	1	2-1/2	9163526	9163527	9163528	9163529	9163681	-	-	-	9163667
		1-1/4	3	9163530	9163531	9163532	9163533	9163682	9163534	-	-	9163673
		1-1/2	3-1/2	9163535	-	9163536	9163537	9163683	-	-	-	9163674
		2	4	9163538	-	-	-	-	-	-	-	-
		2-1/2	4-1/2	9163539	-	-	-	-	-	-	-	-
7/16	7/16	1	2-3/4	9163540	-	-	-	-	-	-	-	
1/2	1/2	5/8	2-1/2	9163541	9163542	9163543	-	-	-	-	-	-
		5/8	3	9163544	9163545	9163546	9163547	9163548	9163549	-	-	9163668
		3/4	3	9163550	-	-	-	-	-	-	-	-
		1	3	9163551	9163552	9163553	9163554	9163555	9163556	-	-	9163669
		1-1/4	3	9163557	9163558	9163559	9163561	9163562	9163563	-	-	9163670
		1-5/8	4	9163564	9163565	9163566	9163567	9163568	9163569	-	-	-
		2	4	9163570	9163571	9163572	9163573	9163574	9163575	-	-	-
		2-1/4	4	9163576	-	-	-	-	-	-	-	-
		2-1/2	5	9163577	-	9163578	9163679	9163684	9163685	-	-	9163675
		2-1/2	6	9163579	-	-	-	-	-	-	-	-
3-1/4	6	9163580	-	-	-	-	-	-	-	-		
5/8	5/8	4	8	9163581	-	-	-	-	-	-	-	-
		3/4	3-1/2	9163582	-	9163583	-	-	9163584	-	-	-
		1-1/4	3-1/2	9163585	-	9163586	-	-	9163587	-	-	-
		1-5/8	4	9163588	9163589	9163590	-	-	9163591	-	-	9163671
		1-7/8	4	9163592	-	9163593	-	-	9163594	-	-	-
		2-1/8	5	9163595	-	-	-	-	-	-	-	-
		2-1/2	5	9163596	-	9163597	-	-	-	-	-	-
3-1/4	6	9163598	-	-	-	-	-	-	-	-		
3/4	3/4	1	4	9163599	-	9163600	9163601	9163602	9163603	9163604	9163605	-
		1-5/8	4	9163606	-	9163607	9163608	9163609	9163610	9163611	9163612	9163672
		2	5	9163613	-	-	-	-	9163614	-	-	-
		2-1/4	5	9163615	-	9163616	9163617	9163618	9163619	-	9163620	-
		2-1/2	5	9163621	-	9163622	9163623	-	9163624	9163625	9163626	-
		3	6	9163627	-	-	-	-	-	-	-	-
		3-1/4	6	9163628	-	9163629	-	-	9163630	-	-	-
		3-1/2	6	9163631	-	-	-	-	9163632	-	-	-
		4	7	9163633	-	-	-	-	-	-	-	-
1	1	5	8	9163634	-	-	-	-	-	-	-	
		1-1/4	4	9163635	-	-	-	-	-	-	-	
		1-1/2	4	9163636	-	9163637	9163638	9163639	9163640	-	9163641	-
		2	5	9163642	-	-	-	-	-	-	-	
		2-1/2	5	9163643	-	9163644	9163645	9163646	9163647	-	9163648	-
		3-1/2	6	9163649	-	9163650	9163651	9163652	9163653	-	9163654	-
		4-1/4	7	9163655	-	9163656	-	-	-	-	-	
5-1/2	8	9163657	-	-	-	-	-	-	-			

M213C STREAKERS



For high-performance machining in aluminum alloys. Designed to handle extreme tool paths in aluminum alloys – the NEW STREAKERS M213 end mills provide a superior surface finish and are engineered to meet the demands of today’s aerospace industry. The M213C adds the benefits of our unique **Chip Management System (CMS)** for maximum chip control.

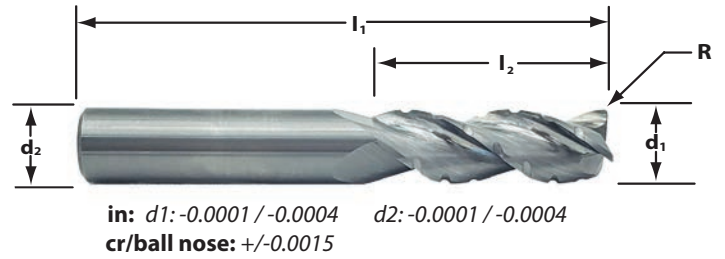

Cutter Dia d1	Shank Dia d2	Length of Cut I2	Overall Length I1	Order Code by Corner Radius				
				.015 CR	.031 CR	.062 CR	.093 CR	.125 CR
1/4	1/4	1/2	2-1/2	9163847	-	-	-	-
		3/4	2-1/2	9163848	-	-	-	-
		1	3	9163849	-	-	-	-
3/8	3/8	15/16	2-1/2	9163850	-	-	-	-
		1-1/8	3	9163851	-	-	-	-
		1-1/2	3-1/2	9163852	-	-	-	-
1/2	1/2	1-1/4	3	-	9163853	9163863	9163867	-
		1-1/2	3-1/2	-	9163854	-	-	-
		2	4	-	9163855	-	-	-
5/8	5/8	1-1/4	3-1/2	-	9163856	9163864	9163868	9163871
		1-7/8	4	-	9163857	-	-	-
3/4	3/4	1-5/8	4	-	9163859	9163865	9163869	9163872
		2-1/4	5	-	9163860	-	-	-
1	1	1-1/2	4	-	9163861	9163866	9163870	9163873
		2-1/4	5	-	9163862	-	-	-

M213 Series Application Guide – Speed & Feed (metric)

ISO Code	Work Material	Type of Cut	Tool LC/ Dia.	Axial DOC	Radial DOC	Ramp Angle	Number of Flutes	Speed (SFM)	Feed (Inch per Tooth)								
									1/8	3/16	1/4	5/16	3/8	1/2	5/8	3/4	1
N	Aluminum alloys 2024, 6061, 7075 Magnesium alloys O-T6	Slotting	≤ 2	1 x D	1 x D	-	3	800	.0015	.0023	.0030	.0038	.0045	.0060	.0075	.0090	.0120
		Peripheral - Rough	≤ 2	1 x D	.75 x D	-	3	1000	.0020	.0030	.0040	.0050	.0060	.0080	.0100	.0120	.0160
		Peripheral - Rough	> 2 - 3	1 x D	.75 x D	-	3	1000	.0019	.0028	.0038	.0047	.0056	.0075	.0094	.0113	.0150
		Peripheral - Rough	> 3 - 4	1 x D	.75 x D	-	3	900	.0016	.0024	.0032	.0041	.0049	.0065	.0081	.0097	.0130
		Peripheral - Rough	> 4 - 5	1 x D	.75 x D	-	3	800	.0014	.0022	.0029	.0036	.0043	.0058	.0072	.0086	.0115
		Finish	≤ 2.5	2 x D	.015 x D	-	3	1200	.0007	.0010	.0014	.0017	.0020	.0027	.0034	.0041	.0054
	Helical Ramp	≤ 2	2 x D	1 x D	15 deg	3	800	.0015	.0023	.0030	.0038	.0045	.0060	.0075	.0090	.0120	
	Straight Line Ramp	≤ 2	1 x D	1 x D	45 deg	3	800	.0010	.0015	.0020	.0025	.0030	.0040	.0050	.0060	.0080	
	Aluminum alloys 2024, 6061, 7075 Hardened or Anodized	Slotting	≤ 2	1 x D	1 x D	-	3	780	.0014	.0020	.0027	.0034	.0041	.0055	.0068	.0082	.0109
		Peripheral - Rough	≤ 2	1 x D	.75 x D	-	3	950	.0020	.0029	.0039	.0049	.0059	.0078	.0098	.0117	.0156
		Peripheral - Rough	> 2 - 3	1 x D	.75 x D	-	3	950	.0018	.0027	.0037	.0046	.0055	.0073	.0092	.0110	.0147
		Peripheral - Rough	> 3 - 4	1 x D	.625 x D	-	3	855	.0016	.0024	.0032	.0039	.0047	.0063	.0079	.0095	.0126
		Peripheral - Rough	> 4 - 5	1 x D	.625 x D	-	3	760	.0014	.0021	.0028	.0035	.0042	.0056	.0070	.0084	.0112
		Finish	≤ 2.5	2 x D	.010 x D	-	3	1170	.0006	.0009	.0012	.0015	.0018	.0024	.0030	.0037	.0049
	Helical Ramp	≤ 2	2 x D	1 x D	15 deg	3	800	.0015	.0023	.0030	.0038	.0045	.0060	.0075	.0090	.0120	
	Straight Line Ramp	≤ 2	1 x D	1 x D	45 deg	3	800	.0010	.0015	.0020	.0025	.0030	.0040	.0050	.0060	.0080	
	High Silicon Aluminum Alloys A380, A390 Bhn 30-150 500kg	Slotting	≤ 2	.75 x D	1 x D	-	3	500	.0011	.0017	.0023	.0028	.0034	.0045	.0056	.0068	.0090
		Peripheral - Rough	≤ 2	1 x D	.5 x D	-	3	700	.0014	.0021	.0029	.0036	.0043	.0057	.0071	.0086	.0114
Peripheral - Rough		> 2 - 3	1 x D	.5 x D	-	3	700	.0014	.0021	.0027	.0034	.0041	.0055	.0068	.0082	.0109	
Peripheral - Rough		> 3 - 4	1 x D	.4 x D	-	3	600	.0012	.0018	.0024	.0030	.0036	.0048	.0061	.0073	.0097	
Peripheral - Rough		> 4 - 5	1 x D	.4 x D	-	3	500	.0010	.0015	.0020	.0025	.0030	.0040	.0051	.0061	.0081	
Finish		≤ 2.5	2 x D	.015 x D	-	3	900	.0006	.0009	.0013	.0016	.0019	.0025	.0031	.0038	.0050	
Helical Ramp	≤ 2	2 x D	1 x D	15 deg	3	500	.0011	.0017	.0023	.0028	.0034	.0045	.0056	.0068	.0090		
Straight Line Ramp	≤ 2	1 x D	1 x D	45 deg	3	500	.0008	.0011	.0015	.0019	.0023	.0030	.0038	.0045	.0061		
High Silicon Aluminum alloys A380, A390 Anodized	Slotting	≤ 2	.75 x D	1 x D	-	3	488	.0010	.0015	.0020	.0025	.0030	.0040	.0050	.0060	.0080	
	Peripheral - Rough	≤ 2	1 x D	.45 x D	-	3	690	.0014	.0021	.0029	.0036	.0043	.0057	.0071	.0086	.0114	
	Peripheral - Rough	> 2 - 3	1 x D	.45 x D	-	3	690	.0014	.0021	.0027	.0034	.0041	.0055	.0068	.0082	.0109	
	Peripheral - Rough	> 3 - 4	1 x D	.375 x D	-	3	621	.0012	.0018	.0024	.0030	.0036	.0048	.0061	.0073	.0097	
	Peripheral - Rough	> 4 - 5	1 x D	.375 x D	-	3	552	.0010	.0015	.0020	.0025	.0030	.0040	.0051	.0061	.0081	
	Finish	≤ 2.5	2 x D	.010 x D	-	3	878	.0006	.0008	.0011	.0014	.0017	.0022	.0028	.0034	.0045	
Helical Ramp	≤ 2	2 x D	1 x D	15 deg	3	488	.0010	.0015	.0020	.0025	.0030	.0040	.0050	.0060	.0080		
Straight Line Ramp	≤ 2	1 x D	1 x D	45 deg	3	488	.0007	.0010	.0013	.0017	.0020	.0027	.0033	.0040	.0053		
Copper, Brass 10-80 HRb	Slotting	≤ 2	.75 x D	1 x D	-	3	500	.0009	.0014	.0019	.0023	.0028	.0037	.0046	.0056	.0074	
	Peripheral - Rough	≤ 2	1 x D	.75 x D	-	3	600	.0012	.0017	.0023	.0029	.0035	.0046	.0058	.0069	.0092	
	Peripheral - Rough	> 2 - 3	1 x D	.75 x D	-	3	600	.0011	.0017	.0022	.0028	.0033	.0045	.0056	.0067	.0089	
	Peripheral - Rough	> 3 - 4	1 x D	.75 x D	-	3	500	.0010	.0014	.0019	.0024	.0029	.0039	.0048	.0058	.0077	
	Peripheral - Rough	> 4 - 5	1 x D	.75 x D	-	3	450	.0008	.0012	.0017	.0021	.0025	.0033	.0041	.0050	.0066	
	Finish	≤ 2.5	2 x D	.015 x D	-	3	650	.0005	.0008	.0011	.0013	.0016	.0021	.0026	.0032	.0042	
Helical Ramp	≤ 2	2 x D	1 x D	15 deg	3	500	.0009	.0014	.0019	.0023	.0028	.0037	.0046	.0056	.0074		
Straight Line Ramp	≤ 2	1 x D	1 x D	25 deg	3	500	.0006	.0009	.0012	.0016	.0019	.0025	.0031	.0037	.0050		
Copper alloys, Brass Alloys 81-100 HRb	Slotting	≤ 2	.75 x D	1 x D	-	3	488	.0009	.0014	.0018	.0023	.0027	.0036	.0045	.0054	.0072	
	Peripheral - Rough	≤ 2	1 x D	.75 x D	-	3	590	.0012	.0017	.0023	.0029	.0035	.0046	.0058	.0069	.0092	
	Peripheral - Rough	> 2 - 3	1 x D	.75 x D	-	3	590	.0011	.0017	.0022	.0028	.0033	.0044	.0055	.0066	.0088	
	Peripheral - Rough	> 3 - 4	1 x D	.625 x D	-	3	492	.0009	.0014	.0019	.0024	.0028	.0038	.0047	.0057	.0075	
	Peripheral - Rough	> 4 - 5	1 x D	.625 x D	-	3	443	.0008	.0012	.0016	.0020	.0024	.0032	.0040	.0048	.0064	
	Finish	≤ 2.5	2 x D	.010 x D	-	3	634	.0005	.0007	.0010	.0012	.0015	.0020	.0024	.0029	.0039	
Helical Ramp	≤ 2	2 x D	1 x D	15 deg	3	488	.0009	.0014	.0018	.0023	.0027	.0036	.0045	.0054	.0072		
Straight Line Ramp	≤ 2	1 x D	1 x D	25 deg	3	488	.0006	.0009	.0012	.0015	.0018	.0024	.0030	.0036	.0048		
Bronze Bhn 166-186	Slotting	≤ 2	.75 x D	1 x D	-	3	500	.0009	.0013	.0018	.0022	.0026	.0035	.0044	.0053	.0070	
	Peripheral - Rough	≤ 2	1 x D	.5 x D	-	3	600	.0011	.0017	.0022	.0028	.0033	.0044	.0055	.0066	.0088	
	Peripheral - Rough	> 2 - 3	1 x D	.5 x D	-	3	600	.0010	.0016	.0021	.0026	.0031	.0042	.0052	.0063	.0084	
	Peripheral - Rough	> 3 - 4	1 x D	.4 x D	-	3	500	.0009	.0013	.0018	.0022	.0026	.0035	.0044	.0053	.0070	
	Peripheral - Rough	> 4 - 5	1 x D	.4 x D	-	3	450	.0007	.0011	.0015	.0019	.0022	.0030	.0037	.0045	.0059	
	Finish	≤ 2.5	2 x D	.015 x D	-	3	650	.0005	.0007	.0010	.0012	.0014	.0019	.0024	.0029	.0038	
Helical Ramp	≤ 2	2 x D	1 x D	12 deg	3	500	.0009	.0013	.0018	.0022	.0026	.0035	.0044	.0053	.0070		
Straight Line Ramp	≤ 2	1 x D	1 x D	20 deg	3	500	.0006	.0009	.0012	.0015	.0018	.0023	.0029	.0035	.0047		
Bronze High Tin Bronze, Manganese Bronze Work Hardened Bronze Bhn 187-212	Slotting	≤ 2	.75 x D	1 x D	-	3	488	.0009	.0013	.0017	.0021	.0026	.0034	.0043	.0051	.0068	
	Peripheral - Rough	≤ 2	1 x D	.45 x D	-	3	590	.0011	.0017	.0022	.0028	.0033	.0044	.0055	.0066	.0088	
	Peripheral - Rough	> 2 - 3	1 x D	.45 x D	-	3	590	.0010	.0016	.0021	.0026	.0031	.0042	.0052	.0063	.0084	
	Peripheral - Rough	> 3 - 4	1 x D	.375 x D	-	3	492	.0009	.0013	.0018	.0022	.0026	.0035	.0044	.0053	.0070	
	Peripheral - Rough	> 4 - 5	1 x D	.375 x D	-	3	443	.0007	.0011	.0015	.0019	.0022	.0030	.0037	.0045	.0059	
	Finish	≤ 2.5	2 x D	.010 x D	-	3	634	.0004	.0007	.0009	.0011	.0013	.0018	.0022	.0026	.0035	
Helical Ramp	≤ 2	2 x D	1 x D	12 deg	3	488	.0009	.0013	.0017	.0021	.0026	.0034	.0043	.0051	.0068		
Straight Line Ramp	≤ 2	1 x D	1 x D	20 deg	3	488	.0006	.0009	.0011	.0014	.0017	.0023	.0029	.0034	.0046		
Composites, Plastics, Fiberglass	Slotting	≤ 2	1 x D	1 x D	-	3	500	.0011	.0017	.0023	.0028	.0034	.0045	.0056	.0068	.0090	
	Peripheral - Rough	≤ 2	1 x D	.75 x D	-	3	700	.0014	.0021	.0029	.0036	.0043	.0057	.0071	.0086	.0114	
	Peripheral - Rough	> 2 - 3	1 x D	.75 x D	-	3	700	.0014	.0021	.0027	.0034	.0041	.0055	.0068	.0082	.0109	
	Peripheral - Rough	> 3 - 4	1 x D	.75 x D	-	3	600	.0012	.0018	.0024	.0030	.0036	.0048	.0061	.0073	.0097	
	Peripheral - Rough	> 4 - 5	1 x D	.75 x D	-	3	500	.0010	.0015	.0020	.0025	.0030	.0040	.0051	.0061	.0081	
	Finish	≤ 2.5	2 x D	.015 x D	-	3	900	.0006	.0009	.0013	.0016	.0019	.0025	.0031	.0038	.0050	
Helical Ramp	≤ 2	2 x D	1 x D	15 deg	3	500	.0011	.0017	.0023	.0028	.0034	.0045	.0056	.0068	.0090		
Straight Line Ramp	≤ 2	1 x D	1 x D	45 deg	3	500	.0008	.0011	.0015	.0019	.0023	.0030	.0038	.0045	.0061		

** D = Tool Diameter The M213 excels at plunge milling, please refer to page 11 for speed, feed and peck info. Tool LC/Dia equals amount of tool projection from the holder.**

M213N STREAKERS



For high-performance machining in aluminum alloys. Designed to handle extreme tool paths in aluminum alloys – the NEW STREAKERS M213 end mills provide superior surface finishes and are engineered to meet the demands of today’s aerospace industry. The M213N with reduced neck, allows for milling in deep cavities while minimizing tool deflection.

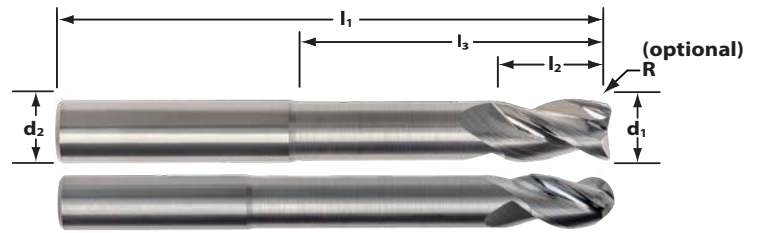

$d1: -0.0001 / -0.0004$ $d2: -0.0001 / -0.0004$
 $cr/ball\ nose: +/- 0.0015$



Cutter Dia d1	Shank Dia d2	Length of Cut l2	Reach LBS l3	Overall Length l1	Order Code SQ	Order Code by Corner Radius							Order Code BN
						.015 CR	.031 CR	.062 CR	.093 CR	.125 CR	.187 CR	.250 CR	
1/8	1/8	3/16	3/4	2-1/2	9163686	9163718	-	-	-	-	-	-	9163815
			5/8	3	9163687	9163719	-	-	-	-	-	-	9163816
			1	3	9163688	9163720	-	-	-	-	-	-	9163817
3/16	3/16	1/4	3/4	2-1/2	9163689	9163721	9163736	-	-	-	-	-	9163818
			1	3	9163690	9163722	9163737	-	-	-	-	-	9163819
1/4	1/4	3/8	7/8	2-1/2	9163691	9163723	9163738	9163765	-	-	-	-	9163820
			1-3/8	3	9163692	9163724	9163739	-	-	-	-	-	9163821
			1-5/8	3	9163693	9163725	9163740	9163766	-	-	-	-	9163822
			2-1/4	4	9163694	9163726	9163741	-	-	-	-	-	9163823
3/8	3/8	5/8	1-1/8	2-1/2	9163695	9163727	9163742	9163767	9163784	-	-	-	9163824
			1-1/4	3	9163696	9163728	9163743	9163768	-	-	-	-	9163825
			1-5/8	3	9163697	9163729	9163744	9163769	-	-	-	-	9163826
			2-1/4	4	9163698	9163730	9163745	-	-	-	-	-	9163827
			2-1/2	5	9163699	-	9163746	9163770	-	-	-	-	9163828
			3-1/8	6	9163700	9163731	9163747	-	-	-	-	-	9163829
1/2	1/2	5/8	1-3/8	3	9163701	9163732	9163748	9163771	9163785	9163791	-	-	9163830
			1-3/4	3-1/2	9163702	-	9163749	9163772	-	9163792	-	-	9163831
		3/4	2-1/4	4	9163703	9163733	9163750	9163773	9163786	9163793	-	-	9163832
			2-3/4	4-1/2	9163704	-	9163751	9163774	-	9163794	-	-	9163833
			3-1/4	5	9163705	9163734	9163752	9163775	-	9163795	-	-	9163834
			3-3/4	5	9163706	-	9163753	-	-	-	-	-	9163835
5/8	5/8	3/4	4-1/4	6	9163707	9163735	9163754	9163776	9163787	9163796	-	-	9163836
			1-3/4	4	9163708	-	9163755	-	-	9163797	-	-	9163837
			2-3/8	5	9163709	-	9163756	9163777	9163788	9163798	-	-	9163838
3/4	3/4	1	3-3/8	6	9163710	-	9163757	-	-	9163799	-	-	9163839
			1-3/4	4	9163711	-	9163758	9163778	9163789	9163800	9163807	9163809	9163840
			2-3/8	5	9163712	-	9163759	9163779	-	9163801	-	-	9163841
			3-3/8	6	9163713	-	9163760	9163780	9163790	9163802	9163808	9163810	9163842
1	1	1-1/4	5	7	9163714	-	9163761	9163781	-	9163803	-	9163811	9163843
			2-5/8	5	9163715	-	9163762	9163782	-	9163804	-	9163812	9163844
			3-3/8	6	9163716	-	9163763	-	-	9163805	-	9163813	9163845
			4-3/8	7	9163717	-	9163764	9163783	-	9163806	-	9163814	9163846

M213N Series Application Guide – Speed & Feed (inch)

ISO Code	Work Material	Type of Cut	Tool LBS/ Dia.	Axial DOC	Radial DOC	Ramp Angle	Number of Flutes	Speed (SFM)	Feed (Inch per Tooth)							
									1/8	3/16	1/4	3/8	1/2	5/8	3/4	1
N	Aluminum alloys 2024, 6061, 7075 Magnesium alloys O-T6	Slotting	>2-3	1 x D	1 x D	-	3	800	.0015	.0023	.0030	.0045	.0060	.0075	.0090	.0120
		Peripheral - Rough	>2-3	1 x D	.75 x D	-	3	1000	.0020	.0030	.0040	.0060	.0080	.0100	.0120	.0160
		Peripheral - Rough	>3-4	1 x D	.75 x D	-	3	1000	.0019	.0028	.0038	.0056	.0075	.0094	.0113	.0150
		Peripheral - Rough	>4-5	1 x D	.75 x D	-	3	900	.0016	.0024	.0032	.0049	.0065	.0081	.0097	.0130
		Peripheral - Rough	>5-6	1 x D	.625 x D	-	3	800	.0014	.0022	.0029	.0043	.0058	.0072	.0086	.0115
		Finish	>2-3	3 x D	.015 x D	-	3	1200	.0007	.0010	.0014	.0020	.0027	.0034	.0041	.0054
		Helical Ramp	>2-3	3 x D	1 x D	15 deg	3	800	.0015	.0023	.0030	.0045	.0060	.0075	.0090	.0120
		Straight Line Ramp	>2-3	1 x D	1 x D	45 deg	3	800	.0010	.0015	.0020	.0030	.0040	.0050	.0060	.0080
		Slotting	>2-3	1 x D	1 x D	-	3	780	.0014	.0020	.0027	.0041	.0055	.0068	.0082	.0109
		Peripheral - Rough	>2-3	1 x D	.75 x D	-	3	950	.0020	.0029	.0039	.0059	.0078	.0098	.0117	.0156
Aluminum alloys 2024, 6061, 7075 Hardened or Anodized	Peripheral - Rough	>3-4	1 x D	.625 x D	-	3	950	.0018	.0027	.0037	.0055	.0073	.0092	.0110	.0147	
	Peripheral - Rough	>4-5	1 x D	.625 x D	-	3	855	.0016	.0024	.0032	.0047	.0063	.0079	.0095	.0126	
	Peripheral - Rough	>5-6	.75 x D	.5 x D	-	3	760	.0014	.0021	.0028	.0042	.0056	.0070	.0084	.0112	
	Finish	>2-3	3 x D	.010 x D	-	3	1170	.0006	.0009	.0012	.0018	.0024	.0030	.0037	.0049	
	Helical Ramp	>2-3	3 x D	1 x D	15 deg	3	780	.0014	.0020	.0027	.0041	.0055	.0068	.0082	.0109	
	Straight Line Ramp	>2-3	1 x D	1 x D	45 deg	3	780	.0009	.0014	.0018	.0027	.0037	.0046	.0055	.0073	
	Slotting	>2-3	.75 x D	1 x D	-	3	500	.0011	.0017	.0023	.0034	.0045	.0056	.0068	.0090	
	Peripheral - Rough	>2-3	1 x D	.5 x D	-	3	700	.0014	.0021	.0029	.0043	.0057	.0071	.0086	.0114	
	Peripheral - Rough	>3-4	1 x D	.4 x D	-	3	700	.0014	.0021	.0027	.0041	.0055	.0068	.0082	.0109	
	Peripheral - Rough	>4-5	1 x D	.4 x D	-	3	600	.0012	.0018	.0024	.0036	.0048	.0061	.0073	.0097	
High Silicon Aluminum Alloys A380, A390 Bhn 30-150 500kg	Peripheral - Rough	>5-6	1 x D	.3 x D	-	3	500	.0010	.0015	.0020	.0030	.0040	.0051	.0061	.0081	
	Finish	>2-3	3 x D	.015 x D	-	3	900	.0006	.0009	.0013	.0019	.0025	.0031	.0038	.0050	
	Helical Ramp	>2-3	3 x D	1 x D	15 deg	3	500	.0011	.0017	.0023	.0034	.0045	.0056	.0068	.0090	
	Straight Line Ramp	>2-3	1 x D	1 x D	45 deg	3	500	.0008	.0011	.0015	.0023	.0030	.0038	.0045	.0061	
	Slotting	>2-3	.75 x D	1 x D	-	3	488	.0010	.0015	.0020	.0030	.0040	.0050	.0060	.0080	
	Peripheral - Rough	>2-3	1 x D	.45 x D	-	3	690	.0014	.0021	.0029	.0043	.0057	.0071	.0086	.0114	
	Peripheral - Rough	>3-4	1 x D	.375 x D	-	3	690	.0014	.0021	.0027	.0041	.0055	.0068	.0082	.0109	
	Peripheral - Rough	>4-5	1 x D	.375 x D	-	3	621	.0012	.0018	.0024	.0036	.0048	.0061	.0073	.0097	
	Peripheral - Rough	>5-6	.75 x D	.3 x D	-	3	552	.0010	.0015	.0020	.0030	.0040	.0051	.0061	.0081	
	Finish	>2-3	3 x D	.010 x D	-	3	878	.0006	.0008	.0011	.0017	.0022	.0028	.0034	.0045	
High Silicon Aluminum alloys A380, A390 Anodized	Helical Ramp	>2-3	3 x D	1 x D	15 deg	3	488	.0010	.0015	.0020	.0030	.0040	.0050	.0060	.0080	
	Straight Line Ramp	>2-3	1 x D	1 x D	45 deg	3	488	.0007	.0010	.0013	.0020	.0027	.0033	.0040	.0053	
	Slotting	>2-3	.75 x D	1 x D	-	3	500	.0009	.0014	.0019	.0028	.0037	.0046	.0056	.0074	
	Peripheral - Rough	>2-3	1 x D	.75 x D	-	3	600	.0012	.0017	.0023	.0035	.0046	.0058	.0069	.0092	
	Peripheral - Rough	>3-4	1 x D	.75 x D	-	3	600	.0011	.0017	.0022	.0033	.0045	.0056	.0067	.0089	
	Peripheral - Rough	>4-5	1 x D	.75 x D	-	3	500	.0010	.0014	.0019	.0029	.0039	.0048	.0058	.0077	
	Peripheral - Rough	>5-6	1 x D	.625 x D	-	3	450	.0008	.0012	.0017	.0025	.0033	.0041	.0050	.0066	
	Finish	>2-3	3 x D	.015 x D	-	3	650	.0005	.0008	.0011	.0016	.0021	.0026	.0032	.0042	
	Helical Ramp	>2-3	3 x D	1 x D	15 deg	3	500	.0009	.0014	.0019	.0028	.0037	.0046	.0056	.0074	
	Straight Line Ramp	>2-3	1 x D	1 x D	25 deg	3	500	.0006	.0009	.0012	.0019	.0025	.0031	.0037	.0050	
Copper, Brass	Slotting	>2-3	.75 x D	1 x D	-	3	488	.0009	.0014	.0018	.0027	.0036	.0045	.0054	.0072	
	Peripheral - Rough	>2-3	1 x D	.75 x D	-	3	590	.0012	.0017	.0023	.0035	.0046	.0058	.0069	.0092	
	Peripheral - Rough	>3-4	1 x D	.625 x D	-	3	590	.0011	.0017	.0022	.0033	.0044	.0055	.0066	.0088	
	Peripheral - Rough	>4-5	1 x D	.625 x D	-	3	492	.0009	.0014	.0019	.0028	.0038	.0047	.0057	.0075	
	Peripheral - Rough	>5-6	.75 x D	.5 x D	-	3	443	.0008	.0012	.0016	.0024	.0032	.0040	.0048	.0064	
	Finish	>2-3	3 x D	.010 x D	-	3	634	.0005	.0007	.0010	.0015	.0020	.0024	.0029	.0039	
	Helical Ramp	>2-3	3 x D	1 x D	15 deg	3	488	.0009	.0014	.0018	.0027	.0036	.0045	.0054	.0072	
	Straight Line Ramp	>2-3	1 x D	1 x D	25 deg	3	488	.0006	.0009	.0012	.0018	.0024	.0030	.0036	.0048	
	Slotting	>2-3	.75 x D	1 x D	-	3	500	.0009	.0013	.0018	.0026	.0035	.0044	.0053	.0070	
	Peripheral - Rough	>2-3	1 x D	.5 x D	-	3	600	.0011	.0017	.0022	.0033	.0044	.0055	.0066	.0088	
Copper alloys, Brass Alloys	Peripheral - Rough	>3-4	1 x D	.4 x D	-	3	600	.0010	.0016	.0021	.0031	.0042	.0052	.0063	.0084	
	Peripheral - Rough	>4-5	1 x D	.4 x D	-	3	500	.0009	.0013	.0018	.0026	.0035	.0044	.0053	.0070	
	Peripheral - Rough	>5-6	1 x D	.3 x D	-	3	450	.0007	.0011	.0015	.0022	.0030	.0037	.0045	.0059	
	Finish	>2-3	3 x D	.015 x D	-	3	650	.0005	.0007	.0010	.0014	.0019	.0024	.0029	.0038	
	Helical Ramp	>2-3	3 x D	1 x D	12 deg	3	500	.0009	.0013	.0018	.0026	.0035	.0044	.0053	.0070	
	Straight Line Ramp	>2-3	1 x D	1 x D	20 deg	3	500	.0006	.0009	.0012	.0018	.0023	.0029	.0035	.0047	
	Slotting	>2-3	.75 x D	1 x D	-	3	488	.0009	.0013	.0017	.0026	.0034	.0043	.0051	.0068	
	Peripheral - Rough	>2-3	1 x D	.45 x D	-	3	590	.0011	.0017	.0022	.0033	.0044	.0055	.0066	.0088	
	Peripheral - Rough	>3-4	1 x D	.375 x D	-	3	590	.0010	.0016	.0021	.0031	.0042	.0052	.0063	.0084	
	Peripheral - Rough	>4-5	1 x D	.375 x D	-	3	492	.0009	.0013	.0018	.0026	.0035	.0044	.0053	.0070	
Bronze High Tin Bronze, Manganese Bronze Work Hardened Bronze	Peripheral - Rough	>5-6	.75 x D	.3 x D	-	3	443	.0007	.0011	.0015	.0022	.0030	.0037	.0045	.0059	
	Finish	>2-3	3 x D	.010 x D	-	3	634	.0004	.0007	.0009	.0013	.0018	.0022	.0026	.0035	
	Helical Ramp	>2-3	3 x D	1 x D	12 deg	3	488	.0009	.0013	.0017	.0026	.0034	.0043	.0051	.0068	
	Straight Line Ramp	>2-3	1 x D	1 x D	20 deg	3	488	.0006	.0009	.0011	.0017	.0023	.0029	.0034	.0046	
	Slotting	>2-3	1 x D	1 x D	-	3	500	.0011	.0017	.0023	.0034	.0045	.0056	.0068	.0090	
	Peripheral - Rough	>2-3	1 x D	.75 x D	-	3	700	.0014	.0021	.0029	.0043	.0057	.0071	.0086	.0114	
	Peripheral - Rough	>3-4	1 x D	.75 x D	-	3	700	.0014	.0021	.0027	.0041	.0055	.0068	.0082	.0109	
	Peripheral - Rough	>4-5	1 x D	.75 x D	-	3	600	.0012	.0018	.0024	.0036	.0048	.0061	.0073	.0097	
	Peripheral - Rough	>5-6	1 x D	.625 x D	-	3	500	.0010	.0015	.0020	.0030	.0040	.0051	.0061	.0081	
	Finish	>2-3	3 x D	.015 x D	-	3	900	.0006	.0009	.0013	.0019	.0025	.0031	.0038	.0050	
Composites, Plastics, Fiberglass	Helical Entry	>2-3	3 x D	1 x D	15 deg	3	500	.0011	.0017	.0023	.0034	.0045	.0056	.0068	.0090	
	Straight Line Ramp	>2-3	1 x D	1 x D	45 deg	3	500	.0008	.0011	.0015	.0023	.0030	.0038	.0045	.0061	

** D = Tool Diameter The M213 excels at plunge milling, please refer to page 11 for speed, feed and peck info. Tool LC/Dia equals amount of tool projection from the holder.**

M223 STREAKERS



For high-performance machining in aluminum alloys. Improved floor and wall finishes, better ramping ability and longer tool life — all part of the new M223 STREAKERS design. The unique grinds curl and evacuate gummy aluminum chips, allowing high feed rates without chip packing. Excellent for roughing and finishing.

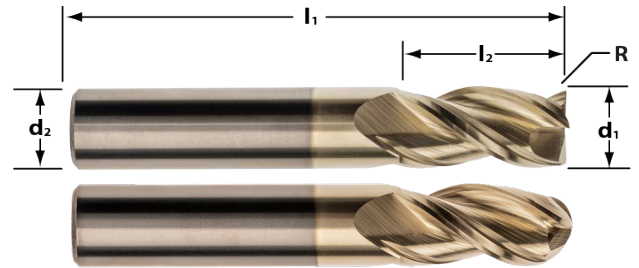

in: d1: -0.0001 / -0.0004 d2: -0.0001 / -0.0004
mm: d1: -0.025 / -0.0100 d2: -0.0025 / -0.0100



Cutter Dia d1	Shank Dia d2	Length of Cut l2	Overall Length l1	Order Code SQ	Order Code by Corner Radius				Order Code BN
					.015 CR	.030 CR	.060 CR	.125 CR	
1/8	1/8	1/4	1-1/2	0334692	-	-	-	-	-
		3/8	1-1/2	0334693	0334694	-	-	-	0334695
		1/2	2	0334696	-	-	-	-	-
3/16	3/16	5/16	2	0334697	-	-	-	-	-
		9/16	2	0334698	0334699	-	-	-	0334700
		3/4	2-1/2	0334701	-	-	-	-	-
1/4	1/4	1/2	2	0334702	0334703	-	-	-	-
		3/4	2-1/2	0334704	0334705	0334706	-	-	0334707
		1	3	0334708	0334709	0334710	-	-	-
5/16	5/16	15/16	2-1/2	0334711	0334712	0334713	-	-	-
		1-3/8	3	0334714	-	-	-	-	-
3/8	3/8	1/2	2	0334715	0334716	-	-	-	-
		15/16	2-1/2	0334717	0334718	0334719	0334720	-	0334721
		1-1/8	3	0334722	0334723	0334724	0334725	-	-
		1-1/2	3-1/2	0334726	0334727	0334728	0334729	-	-
1/2	1/2	2	4	0334730	-	-	-	-	-
		5/8	2-1/2	0334731	-	0334732	-	-	-
		5/8	3	0334733	-	0334734	-	0334735	-
		1	3	0334736	0334737	0334738	0334739	0334740	0334741
		1-1/4	3	0334742	0334743	0334744	0334745	0334746	-
		1-1/2	3-1/2	0334747	-	0334748	0334749	0334750	-
5/8	5/8	2	4	0334751	0334752	0334753	0334754	0334755	-
		2-1/2	5	0334756	-	0334757	-	-	-
		1-1/4	3-1/2	0334758	-	0334759	-	0334760	-
3/4	3/4	1-7/8	4	0334761	-	0334762	-	0334763	0334764
		2-1/2	5	0334765	-	0334766	-	-	-
		1-5/8	4	0334767	-	0334768	0334769	0334770	0334771
1	1	2-1/4	5	0334772	-	0334773	0334774	0334775	-
		3-1/4	6	0334776	-	0334777	-	0334778	-
		1-1/4	4	0334779	-	0334780	-	-	-
1	1	2	5	0334781	-	0334782	-	-	-
		3-1/4	6	0334783	-	0334784	-	-	-
		4-1/4	7	0334785	-	0334786	-	-	-

Cutter Dia d1	Shank Dia d2	Length of Cut l2	Overall Length l1	Order Code SQ	Order Code by Corner Radius						Order Code BN
					0.3 CR	0.5 CR	1.0 CR	1.5 CR	2.0 CR	3.0 CR	
3	3	9	38	0334910	0334911	-	-	-	-	-	0334912
4	4	12	50	0334913	0334914	-	-	-	-	-	0334915
5	5	15	50	0334916	0334917	-	-	-	-	-	0334918
6	6	13	57	0334919	0334920	0334921	0334922	-	-	-	0334923
		18	63	0334924	-	0334925	0334926	-	-	-	-
		24	75	0334927	-	0334928	0334929	-	-	-	-
8	8	20	63	0334930	-	0334931	0334932	-	-	-	0334933
		32	75	0334934	-	0334935	0334936	-	-	-	-
10	10	20	66	0334937	0334938	-	-	-	-	-	-
		22	72	0334939	0334940	-	-	-	-	-	-
		25	72	0334941	0334942	0334943	0334944	0334945	-	-	0334946
		30	75	0334947	-	0334948	0334949	0334950	-	-	-
		40	88	0334951	-	0334952	0334953	0334954	-	-	-
12	12	24	73	0334955	0334956	-	-	-	-	-	-
		26	83	0334957	0334958	0334959	0334960	0334961	0334962	0334963	-
		30	83	0334964	-	0334965	0334966	0334967	0334968	0334969	0334970
		36	88	0334971	-	0334972	0334973	0334974	-	0334975	-
		48	100	0334976	-	0334977	0334978	0334979	0334980	0334981	-
16	16	32	92	0334982	-	0334983	0334984	0334985	0334986	0334987	0334988
		48	110	0334989	-	-	0334990	0334991	0334992	0334993	-
		64	125	0334994	-	-	0334995	0334996	0334997	0334998	-
20	20	40	104	0334999	-	-	0335000	0335001	0335002	0335003	0335004
		60	125	0335005	-	-	0335006	0335007	0335008	0335009	-
		80	150	0335010	-	-	0335011	0335012	0335013	0335014	-
25	25	50	125	0335015	-	-	-	-	-	-	

Cutter Dia d1	Shank Dia d2	Length of Cut l2	Overall Length l1	Order Code SQ
3/8	3/8	15/16	2-1/2	0334787
		1-1/2	3-1/2	0334788
1/2	1/2	1	3	0334789
		1-1/2	3-1/2	0334790
		2	4	0334791
5/8	5/8	1-7/8	4	0334792
		1-5/8	4	0334793
3/4	3/4	2-1/4	5	0334794
		3-1/4	6	0334795
1	1	2	5	0334796
		3-1/4	6	0334797

M223_w/WELDON

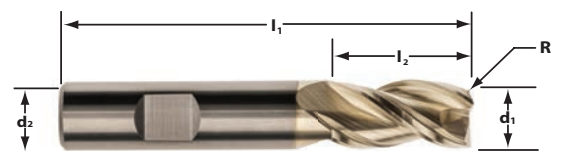

in: $d_1: -0.0001 / -0.0004$ $d_2: -0.0001 / -0.0004$

M223N STREAKERS



For high-performance machining in aluminum alloys. Adding a necked shank to the M223 design offers a high-performance tool that can reach into deep cavities while minimizing tool deflection. Great for work in pockets.

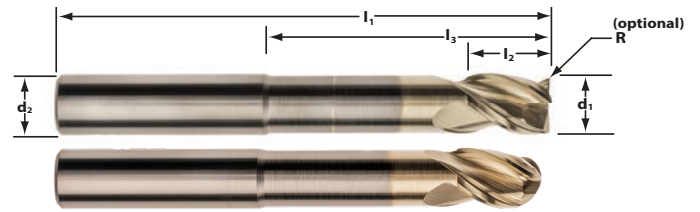

in: d1: -0.0001 / -0.0004 d2: -0.0001 / -0.0004
mm: d1: -0.025 / -0.0100 d2: -0.0025 / -0.0100



Cutter Dia d1	Shank Dia d2	Length of Cut l2	Reach LBS l3	Overall Length l1	Order Code SQ	Order Code by Corner Radius				Order Code BN
						.015 CR	.030 CR	.060 CR	.125 CR	
1/8	1/8	1/4	3/4	2-1/2	0334812	0334813	-	-	-	0334814
			1	3	0334815	0334816	-	-	-	0334817
3/16	3/16	1/4	3/4	2-1/2	0334818	0334819	-	-	-	0334820
			1	3	0334821	0334822	-	-	-	0334823
1/4	1/4	3/8	7/8	2-1/2	0334824	0334825	0334826	-	-	0334827
			1-3/8	3	0334828	0334829	0334830	-	-	0334831
			2-1/4	4	0334832	0334833	0334834	-	-	0334835
3/8	3/8	1/2	1-1/8	2-1/2	0334836	0334837	0334838	0334839	-	0334840
			1-1/4	3	0334841	0334842	0334843	0334844	-	0334845
			2-1/4	4	0334846	0334847	0334848	-	-	0334849
1/2	1/2	5/8	1-3/8	3	0334850	0334851	0334852	0334853	0334854	0334855
			2-1/4	4	0334856	0334857	0334858	0334859	0334860	0334861
			3-1/4	5	0334862	0334863	0334864	0334865	0334866	0334867
			4-1/4	6	0334868	0334869	0334870	0334871	0334872	0334873
5/8	5/8	3/4	1-3/4	4	0334874	-	0334875	-	0334876	0334877
			2-3/8	5	0334878	-	0334879	-	0334880	0334881
			3-3/8	6	0334882	-	0334883	-	0334884	0334885
3/4	3/4	1	1-3/4	4	0334886	-	0334887	0334888	0334889	0334890
			2-3/8	5	0334891	-	0334892	0334893	0334894	0334895
			3-3/8	6	0334896	-	0334897	0334898	0334899	0334900
1	1	1-1/4	2-5/8	5	0334901	-	0334902	-	-	0334903
			3-3/8	6	0334904	-	0334905	-	-	0334906
			4-3/8	7	0334907	-	0334908	-	-	0334909

Cutter Dia d1	Shank Dia d2	Length of Cut l2	Reach LBS l3	Overall Length l1	Order Code SQ	Order Code by Corner Radius						Order Code BN
						0.3 CR	0.5 CR	1.0 CR	1.5 CR	2.0 CR	3.0 CR	
6	6	9	26	63	0335029	0335030	0335031	0335032	-	-	-	0335033
			32	75	0335034	0335035	0335036	0335037	-	-	-	0335038
8	8	12	34	75	0335039	0335040	0335041	0335042	-	-	-	0335043
10	10	15	32	75	0856023	0853374	0853375	0853376	-	-	-	0856031
			42	88	0335044	0335045	0335046	0335047	0335048	-	-	0335049
			52	100	0335050	0335051	0335052	0335053	0335054	-	-	0335055
12	12	18	38	88	0335056	0335057	0335058	0335059	0335060	-	0335061	0335062
			50	100	0335063	0335064	0335065	0335066	0335067	0335068	0335069	0335070
			62	125	0856024	0853377	0853378	0853379	0853380	0853381	0853382	0856032
16	16	24	50	110	0335071	-	0335072	0335073	0335074	0335075	0335076	0335077
			66	125	0335078	-	0335079	0853387	0335080	0335081	0335082	0335083
			82	150	0856025	-	0853390	0853391	0853392	0853393	0853394	0856033
20	20	30	62	125	0335084	-	0335085	0853395	0335086	0853396	0335087	0335088
			82	135	0856026	-	0853397	0853398	0853399	0853400	0853401	0855962
			102	150	0335089	-	0335090	0853434	0335091	0335092	0335093	0335094

TOOL TIP

Coatings for Tools that Machine Aluminum

IMCO offers two types of coating on end mills designed to machine aluminum and copper alloys:

taC (photo A)

The ultimate coating for high-output machining in non-ferrous materials. This thin film coating keeps the tool cutting edges sharp for a high-shear plane. Very hard with high thermal stability and excellent wear resistance.

Find APT/C end mills with taC coating on pages 36–39.

Zirconium Nitride (ZrN) (photo B)

Adds hardness and lubricity to the cutting edge. Reduces edge build-up common in machining gummy materials, enhancing tool life and surface finish. All new M223 and M233 end mills are coated with ZrN.



M223 Series Application Guide – Speed & Feed (inch)

ISO Code	Work Material	Type of Cut	Axial DOC	Radial DOC	Number of Flutes	Speed (SFM)	Feed (Inch per Tooth)							
							1/8	3/16	1/4	3/8	1/2	5/8	3/4	1
N	Aluminum Alloys 6061, 7075, 2024	Slotting	1 x D	1 x D	3	800	.0015	.0030	.0038	.0045	.0060	.0075	.0090	.0120
		Peripheral - Rough	≤ 2 x D	.5 x D	3	1000	.0020	.0040	.0050	.0060	.0080	.0100	.0120	.0160
		Peripheral - Rough	> 2 - 3 x D	.5 x D	3	1000	.0019	.0038	.0047	.0056	.0075	.0094	.0113	.0150
		Peripheral - Rough	> 3 - 4 x D	.45 x D	3	900	.0016	.0033	.0041	.0049	.0065	.0081	.0098	.0130
		Peripheral - Rough	> 4 - 5 x D	.4 x D	3	800	.0015	.0029	.0036	.0044	.0058	.0073	.0087	.0116
		Finish	2.5 x D	.015 x D	3	1200	.0007	.0014	.0017	.0020	.0027	.0034	.0041	.0054
		*Helical Ramp Angle	3.0 deg.	1 x D	3	800	.0012	.0024	.0030	.0036	.0048	.0060	.0072	.0096
	High Silicon Aluminum A380, A390	Slotting	.75 x D	1 x D	3	500	.0011	.0023	.0028	.0034	.0045	.0056	.0068	.0090
		Peripheral - Rough	≤ 2 x D	.4 x D	3	700	.0014	.0029	.0036	.0043	.0057	.0071	.0086	.0114
		Peripheral - Rough	> 2 - 3 x D	.4 x D	3	700	.0014	.0028	.0034	.0041	.0055	.0069	.0083	.0110
		Peripheral - Rough	> 3 - 4 x D	.375 x D	3	600	.0012	.0024	.0030	.0036	.0048	.0060	.0072	.0096
		Peripheral - Rough	> 4 - 5 x D	.35 x D	3	500	.0010	.0020	.0025	.0030	.0040	.0050	.0060	.0080
		Finish	2.5 x D	.015 x D	3	900	.0006	.0013	.0016	.0019	.0025	.0031	.0038	.0050
		*Helical Ramp Angle	2.5 deg.	1 x D	3	500	.0009	.0018	.0023	.0027	.0036	.0045	.0054	.0072
	Magnesium Alloys	Slotting	1 x D	1 x D	3	800	.0015	.0030	.0038	.0045	.0060	.0075	.0090	.0120
		Peripheral - Rough	≤ 2 x D	.5 x D	3	1000	.0020	.0040	.0050	.0060	.0080	.0100	.0120	.0160
		Peripheral - Rough	> 2 - 3 x D	.5 x D	3	1000	.0019	.0038	.0047	.0056	.0075	.0094	.0113	.0150
		Peripheral - Rough	> 3 - 4 x D	.45 x D	3	900	.0016	.0033	.0041	.0049	.0065	.0081	.0098	.0130
		Peripheral - Rough	> 4 - 5 x D	.4 x D	3	800	.0015	.0029	.0036	.0044	.0058	.0073	.0087	.0116
		Finish	2.5 x D	.015 x D	3	1200	.0007	.0014	.0017	.0020	.0027	.0034	.0041	.0054
		*Helical Ramp Angle	3.0 deg.	1 x D	3	800	.0012	.0024	.0030	.0036	.0048	.0060	.0072	.0096
	Copper Alloys, Brass	Slotting	.75 x D	1 x D	3	500	.0009	.0019	.0023	.0028	.0037	.0046	.0056	.0074
		Peripheral - Rough	≤ 2 x D	.4 x D	3	600	.0012	.0023	.0029	.0035	.0046	.0058	.0069	.0092
		Peripheral - Rough	> 2 - 3 x D	.4 x D	3	600	.0011	.0023	.0028	.0034	.0045	.0056	.0068	.0090
		Peripheral - Rough	> 3 - 4 x D	.375 x D	3	500	.0010	.0020	.0024	.0029	.0039	.0049	.0059	.0078
		Peripheral - Rough	> 4 - 5 x D	.35 x D	3	450	.0008	.0017	.0021	.0025	.0033	.0041	.0050	.0066
		Finish	2.5 x D	.015 x D	3	650	.0005	.0011	.0013	.0016	.0021	.0026	.0032	.0042
		*Helical Ramp Angle	2.5 deg.	1 x D	3	500	.0007	.0015	.0019	.0022	.0030	.0037	.0044	.0059
Bronze	Slotting	.75 x D	1 x D	3	500	.0009	.0018	.0022	.0026	.0035	.0044	.0053	.0070	
	Peripheral - Rough	≤ 2 x D	.4 x D	3	600	.0011	.0022	.0028	.0033	.0044	.0055	.0066	.0088	
	Peripheral - Rough	> 2 - 3 x D	.4 x D	3	600	.0011	.0021	.0026	.0032	.0042	.0053	.0063	.0084	
	Peripheral - Rough	> 3 - 4 x D	.375 x D	3	500	.0009	.0018	.0022	.0026	.0035	.0044	.0053	.0070	
	Peripheral - Rough	> 4 - 5 x D	.35 x D	3	450	.0007	.0015	.0018	.0022	.0029	.0036	.0044	.0058	
	Finish	2.5 x D	.015 x D	3	650	.0005	.0010	.0012	.0014	.0019	.0024	.0029	.0038	
	*Helical Ramp Angle	2.0 deg.	1 x D	3	500	.0007	.0014	.0018	.0021	.0028	.0035	.0042	.0056	
Composites, Plastic, Fiberglass	Slotting	.75 x D	1 x D	3	500	.0011	.0023	.0028	.0034	.0045	.0056	.0068	.0090	
	Peripheral - Rough	≤ 2 x D	.4 x D	3	700	.0014	.0029	.0036	.0043	.0057	.0071	.0086	.0114	
	Peripheral - Rough	> 2 - 3 x D	.4 x D	3	700	.0014	.0028	.0034	.0041	.0055	.0069	.0083	.0110	
	Peripheral - Rough	> 3 - 4 x D	.375 x D	3	600	.0012	.0024	.0030	.0036	.0048	.0060	.0072	.0096	
	Peripheral - Rough	> 4 - 5 x D	.35 x D	3	500	.0010	.0020	.0025	.0030	.0040	.0050	.0060	.0080	
	Finish	2.5 x D	.015 x D	3	900	.0006	.0013	.0016	.0019	.0025	.0031	.0038	.0050	
	*Helical Ramp Angle	3.0 deg.	1 x D	3	500	.0009	.0018	.0023	.0027	.0036	.0045	.0054	.0072	

*Straight-Line Ramp Angle = Helical Ramp Angle x 5 for entry up to 1 x D.

≈ Approximately Equals
 ≤ Less Than or Equal To
 ≥ Greater Than or Equal To
 × Multiply
 < Less Than
 > Greater Than
 = Equals

Common Machining Formulas

$$RPM = \frac{SFM \times 3.82}{D}$$

$$SFM = RPM \times D \times .262$$

$$IPM = RPM \times IPT \times Z$$

$$MRR = RDOC \times ADOC \times IPM$$

$$RPM = \frac{M/min \times 318.3}{D}$$

$$M/min = RPM \times D \times .00314$$

$$MMPM = RPM \times MMPT \times Z$$

$$MRR = RDOC \times ADOC \times MMPM$$

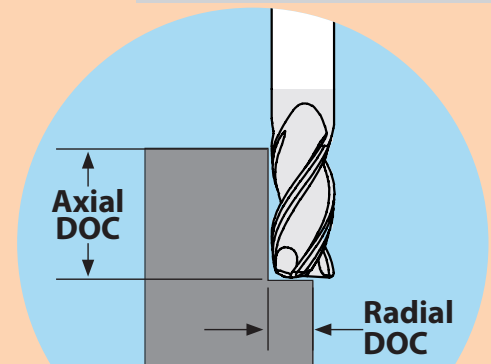

M223 Series Application Guide – Speed & Feed (metric)

ISO Code	Work Material	Type of Cut	Axial DOC	Radial DOC	Number of Flutes	Speed (M/min)	Feed (MM per Tooth)									
							3.0	4.0	5.0	6.0	8.0	10.0	12.0	16.0	20.0	25.0
	Aluminum Alloys 6061, 7075, 2024	Slotting	1 x D	1 x D	3	244	.0360	.0479	.0600	.0720	.0960	.1195	.1440	.1915	.2390	.2995
		Peripheral - Rough	≤ 2 x D	.5 x D	3	305	.0480	.0639	.0800	.0960	.1280	.1593	.1920	.2553	.3187	.3993
		Peripheral - Rough	> 2 - 3 x D	.5 x D	3	305	.0450	.0599	.0750	.0900	.1200	.1494	.1800	.2394	.2988	.3744
		Peripheral - Rough	> 3 - 4 x D	.45 x D	3	274	.0390	.0519	.0650	.0780	.1040	.1295	.1560	.2075	.2589	.3245
		Peripheral - Rough	> 4 - 5 x D	.4 x D	3	244	.0348	.0463	.0580	.0696	.0928	.1155	.1392	.1851	.2311	.2895
		Finish	2.5 x D	.015 x D	3	366	.0162	.0216	.0270	.0324	.0432	.0538	.0648	.0862	.1076	.1348
	*Helical Ramp Angle	3.0 deg.	1 x D	3	244	.0288	.0384	.0480	.0576	.0768	.0956	.1152	.1532	.1912	.2396	
	High Silicon Aluminum A380, A390	Slotting	.75 x D	1 x D	3	152	.0270	.0360	.0450	.0540	.0720	.0896	.1080	.1436	.1793	.2246
		Peripheral - Rough	≤ 2 x D	.4 x D	3	213	.0342	.0456	.0570	.0684	.0912	.1135	.1368	.1819	.2271	.2845
		Peripheral - Rough	> 2 - 3 x D	.4 x D	3	213	.0330	.0440	.0550	.0660	.0880	.1096	.1320	.1755	.2191	.2745
		Peripheral - Rough	> 3 - 4 x D	.375 x D	3	183	.0288	.0384	.0480	.0576	.0768	.0956	.1152	.1532	.1912	.2396
		Peripheral - Rough	> 4 - 5 x D	.35 x D	3	152	.0240	.0320	.0400	.0480	.0640	.0797	.0960	.1277	.1593	.1997
		Finish	2.5 x D	.015 x D	3	274	.0150	.0200	.0250	.0300	.0400	.0498	.0600	.0798	.0996	.1248
	*Helical Ramp Angle	2.5 deg.	1 x D	3	152	.0216	.0288	.0360	.0432	.0576	.0717	.0864	.1149	.1434	.1797	
	Magnesium Alloys	Slotting	1 x D	1 x D	3	244	.0360	.0479	.0600	.0720	.0960	.1195	.1440	.1915	.2390	.2995
		Peripheral - Rough	≤ 2 x D	.5 x D	3	305	.0480	.0639	.0800	.0960	.1280	.1593	.1920	.2553	.3187	.3993
		Peripheral - Rough	> 2 - 3 x D	.5 x D	3	305	.0450	.0599	.0750	.0900	.1200	.1494	.1800	.2394	.2988	.3744
		Peripheral - Rough	> 3 - 4 x D	.45 x D	3	274	.0390	.0519	.0650	.0780	.1040	.1295	.1560	.2075	.2589	.3245
		Peripheral - Rough	> 4 - 5 x D	.4 x D	3	244	.0348	.0463	.0580	.0696	.0928	.1155	.1392	.1851	.2311	.2895
		Finish	2.5 x D	.015 x D	3	366	.0162	.0216	.0270	.0324	.0432	.0538	.0648	.0862	.1076	.1348
	*Helical Ramp Angle	3.0 deg.	1 x D	3	244	.0288	.0384	.0480	.0576	.0768	.0956	.1152	.1532	.1912	.2396	
	Copper Alloys, Brass	Slotting	.75 x D	1 x D	3	152	.0222	.0296	.0370	.0444	.0592	.0737	.0888	.1181	.1474	.1847
		Peripheral - Rough	≤ 2 x D	.4 x D	3	183	.0276	.0368	.0460	.0552	.0736	.0916	.1104	.1468	.1832	.2296
		Peripheral - Rough	> 2 - 3 x D	.4 x D	3	183	.0270	.0360	.0450	.0540	.0720	.0896	.1080	.1436	.1793	.2246
		Peripheral - Rough	> 3 - 4 x D	.375 x D	3	152	.0234	.0312	.0390	.0468	.0624	.0777	.0936	.1245	.1554	.1947
		Peripheral - Rough	> 4 - 5 x D	.35 x D	3	137	.0198	.0264	.0330	.0396	.0528	.0657	.0792	.1053	.1315	.1647
		Finish	2.5 x D	.015 x D	3	198	.0126	.0168	.0210	.0252	.0336	.0418	.0504	.0670	.0837	.1048
	*Helical Ramp Angle	2.5 deg.	1 x D	3	152	.0178	.0237	.0296	.0355	.0474	.0590	.0710	.0945	.1179	.1478	
Bronze	Slotting	.75 x D	1 x D	3	152	.0210	.0280	.0350	.0420	.0560	.0697	.0840	.1117	.1394	.1747	
	Peripheral - Rough	≤ 2 x D	.4 x D	3	183	.0264	.0352	.0440	.0528	.0704	.0876	.1056	.1404	.1753	.2196	
	Peripheral - Rough	> 2 - 3 x D	.4 x D	3	183	.0252	.0336	.0420	.0504	.0672	.0837	.1008	.1341	.1673	.2096	
	Peripheral - Rough	> 3 - 4 x D	.375 x D	3	152	.0210	.0280	.0350	.0420	.0560	.0697	.0840	.1117	.1394	.1747	
	Peripheral - Rough	> 4 - 5 x D	.35 x D	3	137	.0174	.0232	.0290	.0348	.0464	.0578	.0696	.0926	.1155	.1448	
	Finish	2.5 x D	.015 x D	3	198	.0114	.0152	.0190	.0228	.0304	.0378	.0456	.0606	.0757	.0948	
*Helical Ramp Angle	2.0 deg.	1 x D	3	152	.0168	.0224	.0280	.0336	.0448	.0558	.0672	.0894	.1115	.1398		
Composites, Plastic, Fiberglass	Slotting	.75 x D	1 x D	3	152	.0270	.0360	.0450	.0540	.0720	.0896	.1080	.1436	.1793	.2246	
	Peripheral - Rough	≤ 2 x D	.4 x D	3	213	.0342	.0456	.0570	.0684	.0912	.1135	.1368	.1819	.2271	.2845	
	Peripheral - Rough	> 2 - 3 x D	.4 x D	3	213	.0330	.0440	.0550	.0660	.0880	.1096	.1320	.1755	.2191	.2745	
	Peripheral - Rough	> 3 - 4 x D	.375 x D	3	183	.0288	.0384	.0480	.0576	.0768	.0956	.1152	.1532	.1912	.2396	
	Peripheral - Rough	> 4 - 5 x D	.35 x D	3	152	.0240	.0320	.0400	.0480	.0640	.0797	.0960	.1277	.1593	.1997	
	Finish	2.5 x D	.015 x D	3	274	.0150	.0200	.0250	.0300	.0400	.0498	.0600	.0798	.0996	.1248	
*Helical Ramp Angle	3.0 deg.	1 x D	3	152	.0216	.0288	.0360	.0432	.0576	.0717	.0864	.1149	.1434	.1797		

*Straight-Line Ramp Angle = Helical Ramp Angle x 5 for entry up to 1 x D.

- D** Tool Diameter
- Z** Number of Flutes
- RPM** Revolutions per Minute
- SFM** Surface Feet per Minute
- M/min** Surface Meters per Minute
- IPM** Inches per Minute
- MMPM** Millimeters per Minute
- IPT** Inch per Tooth
- MMPT** Millimeters per Tooth
- MRR** Metal Removal Rate
- RDOC** Radial Depth of Cut
- ADOC** Axial Depth of Cut

Technical Resources

Information on tips and adjustments for the following milling operations can be found in our Technical Resources section beginning on page 134.

- HEM slotting
- Face milling
- Helical entry ramping
- Straight line ramping
- Long tool projection adjustments
- Ball nose milling adjustments
- Other helpful tips and calculations

M233 ROUGHER STREAKERS



For high-performance machining in aluminum alloys. Special cutting edge serrations reduce the horsepower needed to plow through aluminum alloys at high metal removal rates. The ZrN coating helps reduce chip packing even in heavy tool engagement cuts.

Tool Tip: M233 Rougher end mills show up to 20% power reduction from M223 in the same cut.

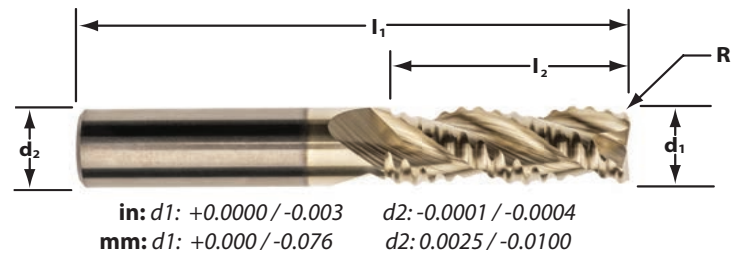

Cutter Dia d1	Shank Dia d2	Length of Cut I2	Overall Length I1	Order Code by Corner Radius	
				.015 CR	.030 CR
1/4	1/4	3/4	2-1/2	0334798	-
		1	3	0334799	-
3/8	3/8	15/16	2-1/2	0334800	-
		1-1/8	3	0334801	-
		1-1/2	3-1/2	0334802	-
1/2	1/2	1-1/4	3	-	0334803
		1-1/2	3-1/2	-	0334804
		2	4	-	0334805
5/8	5/8	1-1/4	3-1/2	-	0334806
		1-7/8	4	-	0334807
3/4	3/4	1-5/8	4	-	0334808
		2-1/4	5	-	0334809
1	1	1-1/4	4	-	0334810
		2	5	-	0334811

Cutter Dia d1	Shank Dia d2	Length of Cut I2	Overall Length I1	Order Code by Corner Radius	
				0.5 CR	1.0 CR
6	6	13	57	0335016	-
		18	63	0335017	-
		24	75	0335018	-
10	10	25	72	0335019	-
		30	75	0335020	-
		40	88	0335021	-
12	12	30	83	-	0335022
		36	88	-	0335023
		48	100	-	0335024
16	16	32	92	-	0335025
		48	110	-	0335026
20	20	40	104	-	0335027
		60	125	-	0335028



M233 Series Application Guide – Speed & Feed (inch)

ISO Code	Work Material	Type of Cut	Axial DOC	Radial DOC	Number of Flutes	Speed (SFM)	Feed (Inches per Tooth)					
							1/4	3/8	1/2	5/8	3/4	1
N	Aluminum Alloys 2024, 6061, 7075	Slotting	1 x D	1 x D	3	800	.0030	.0045	.0060	.0075	.0090	.0120
		Peripheral - Rough	≤ 2 x D	.5 x D	3	1000	.0040	.0060	.0080	.0100	.0120	.0160
		Peripheral - Rough	> 2 - 3 x D	.5 x D	3	1000	.0038	.0056	.0075	.0094	.0113	.0150
		Peripheral - Rough	> 3 - 4 x D	.45 x D	3	900	.0033	.0049	.0065	.0081	.0098	.0130
		*Helical Ramp Angle	3.0 deg.	1 x D	3	800	.0024	.0036	.0048	.0060	.0072	.0096
		High Silicon Aluminum A380, A390	Slotting	.75 x D	1 x D	3	500	.0023	.0034	.0045	.0056	.0068
	Peripheral - Rough		≤ 2 x D	.4 x D	3	700	.0029	.0043	.0057	.0071	.0086	.0114
	Peripheral - Rough		> 2 - 3 x D	.4 x D	3	700	.0028	.0041	.0055	.0069	.0083	.0110
	Peripheral - Rough		> 3 - 4 x D	.375 x D	3	600	.0024	.0036	.0048	.0060	.0072	.0096
	*Helical Ramp Angle		2.5 deg.	1 x D	3	500	.0018	.0027	.0036	.0045	.0054	.0072
	Magnesium Alloys		Slotting	1 x D	1 x D	3	800	.0030	.0045	.0060	.0075	.0090
		Peripheral - Rough	≤ 2 x D	.5 x D	3	1000	.0040	.0060	.0080	.0100	.0120	.0160
		Peripheral - Rough	> 2 - 3 x D	.5 x D	3	1000	.0038	.0056	.0075	.0094	.0113	.0150
		Peripheral - Rough	> 3 - 4 x D	.45 x D	3	900	.0033	.0049	.0065	.0081	.0098	.0130
		*Helical Ramp Angle	3.0 deg.	1 x D	3	800	.0024	.0036	.0048	.0060	.0072	.0096
		Copper Alloys, Brass	Slotting	.75 x D	1 x D	3	500	.0019	.0028	.0037	.0046	.0056
	Peripheral - Rough		≤ 2 x D	.4 x D	3	600	.0023	.0035	.0046	.0058	.0069	.0092
	Peripheral - Rough		> 2 - 3 x D	.4 x D	3	600	.0023	.0034	.0045	.0056	.0068	.0090
	Peripheral - Rough		> 3 - 4 x D	.375 x D	3	500	.0020	.0029	.0039	.0049	.0059	.0078
	*Helical Ramp Angle		2.5 deg.	1 x D	3	500	.0015	.0022	.0030	.0037	.0044	.0059
	Bronze		Slotting	.75 x D	1 x D	3	500	.0018	.0026	.0035	.0044	.0053
		Peripheral - Rough	≤ 2 x D	.4 x D	3	600	.0022	.0033	.0044	.0055	.0066	.0088
		Peripheral - Rough	> 2 - 3 x D	.4 x D	3	600	.0021	.0032	.0042	.0053	.0063	.0084
		Peripheral - Rough	> 3 - 4 x D	.375 x D	3	500	.0018	.0026	.0035	.0044	.0053	.0070
*Helical Ramp Angle		2.0 deg.	1 x D	3	500	.0014	.0021	.0028	.0035	.0042	.0056	
Composites, Plastics, Fiberglass		Slotting	.75 x D	1 x D	3	500	.0023	.0034	.0045	.0056	.0068	.0090
	Peripheral - Rough	≤ 2 x D	.4 x D	3	700	.0029	.0043	.0057	.0071	.0086	.0114	
	Peripheral - Rough	> 2 - 3 x D	.4 x D	3	700	.0028	.0041	.0055	.0069	.0083	.0110	
	Peripheral - Rough	> 3 - 4 x D	.375 x D	3	600	.0024	.0036	.0048	.0060	.0072	.0096	
	*Helical Ramp Angle	3.0 deg.	1 x D	3	500	.0018	.0027	.0036	.0045	.0054	.0072	

*Straight-Line Ramp Angle = Helical ramp angle x 5 for entry up to 1 x D.

Tool Tip: M233 Rougher end mills show up to 20% power reduction from M223 in the same cut.

≈ Approximately Equals < Less Than
 ≤ Less Than or Equal To > Greater Than
 ≥ Greater Than or Equal To = Equals
 x Multiply

Common Machining Formulas

$$RPM = \frac{SFM \times 3.82}{D}$$

$$SFM = RPM \times D \times .262$$

$$IPM = RPM \times IPT \times Z$$

$$MRR = RDOC \times ADOC \times IPM$$

$$RPM = \frac{M/min \times 318.3}{D}$$

$$M/min = RPM \times D \times .00314$$

$$MMPM = RPM \times MMPT \times Z$$

$$MRR = RDOC \times ADOC \times MMPM$$

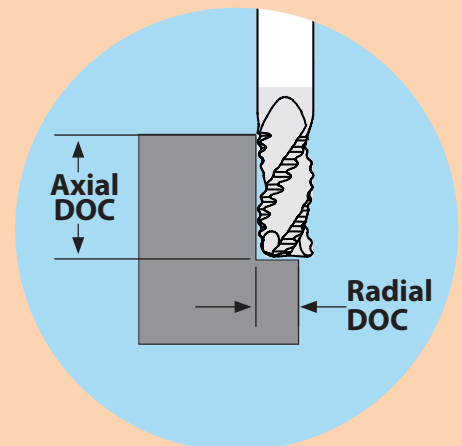

M233 Series Application Guide – Speed & Feed (metric)

ISO Code	Work Material	Type of Cut	Axial DOC	Radial DOC	Number of Flutes	Speed (M/min)	Feed (MM per Tooth)				
							6.0	10.0	12.0	16.0	20.0
	Aluminum Alloys 2024, 6061, 7075	Slotting	1 x D	1 x D	3	244	.0720	.1195	.1440	.1915	.2390
		Peripheral - Rough	≤ 2 x D	.5 x D	3	305	.0960	.1593	.1920	.2553	.3187
		Peripheral - Rough	> 2 - 3 x D	.5 x D	3	305	.0900	.1494	.1800	.2394	.2988
		Peripheral - Rough	> 3 - 4 x D	.45 x D	3	274	.0780	.1295	.1560	.2075	.2589
		*Helical Ramp Angle	3.0 deg.	1 x D	3	244	.0576	.0956	.1152	.1532	.1912
	High Silicon Aluminum A380, A390	Slotting	.75 x D	1 x D	3	152	.0540	.0896	.1080	.1436	.1793
		Peripheral - Rough	≤ 2 x D	.4 x D	3	213	.0684	.1135	.1368	.1819	.2271
		Peripheral - Rough	> 2 - 3 x D	.4 x D	3	213	.0660	.1096	.1320	.1755	.2191
		Peripheral - Rough	> 3 - 4 x D	.375 x D	3	183	.0576	.0956	.1152	.1532	.1912
		*Helical Ramp Angle	2.5 deg.	1 x D	3	152	.0432	.0717	.0864	.1149	.1434
	Magnesium Alloys	Slotting	1 x D	1 x D	3	244	.0720	.1195	.1440	.1915	.2390
		Peripheral - Rough	≤ 2 x D	.5 x D	3	305	.0960	.1593	.1920	.2553	.3187
		Peripheral - Rough	> 2 - 3 x D	.5 x D	3	305	.0900	.1494	.1800	.2394	.2988
		Peripheral - Rough	> 3 - 4 x D	.45 x D	3	274	.0780	.1295	.1560	.2075	.2589
		*Helical Ramp Angle	3.0 deg.	1 x D	3	244	.0576	.0956	.1152	.1532	.1912
	Copper Alloys, Brass	Slotting	.75 x D	1 x D	3	152	.0444	.0737	.0888	.1181	.1474
		Peripheral - Rough	≤ 2 x D	.4 x D	3	183	.0552	.0916	.1104	.1468	.1832
		Peripheral - Rough	> 2 - 3 x D	.4 x D	3	183	.0540	.0896	.1080	.1436	.1793
		Peripheral - Rough	> 3 - 4 x D	.375 x D	3	152	.0468	.0777	.0936	.1245	.1554
		*Helical Ramp Angle	2.5 deg.	1 x D	3	152	.0355	.0590	.0710	.0945	.1179
	Bronze	Slotting	.75 x D	1 x D	3	152	.0420	.0697	.0840	.1117	.1394
		Peripheral - Rough	≤ 2 x D	.4 x D	3	183	.0528	.0876	.1056	.1404	.1753
		Peripheral - Rough	> 2 - 3 x D	.4 x D	3	183	.0504	.0837	.1008	.1341	.1673
		Peripheral - Rough	> 3 - 4 x D	.375 x D	3	152	.0420	.0697	.0840	.1117	.1394
		*Helical Ramp Angle	2.0 deg.	1 x D	3	152	.0336	.0558	.0672	.0894	.1115
	Composites, Plastics, Fiberglass	Slotting	.75 x D	1 x D	3	152	.0540	.0896	.1080	.1436	.1793
		Peripheral - Rough	≤ 2 x D	.4 x D	3	213	.0684	.1135	.1368	.1819	.2271
		Peripheral - Rough	> 2 - 3 x D	.4 x D	3	213	.0660	.1096	.1320	.1755	.2191
Peripheral - Rough		> 3 - 4 x D	.375 x D	3	183	.0576	.0956	.1152	.1532	.1912	
*Helical Ramp Angle		3.0 deg.	1 x D	3	152	.0432	.0717	.0864	.1149	.1434	

*Straight-Line Ramp Angle = Helical ramp angle x 5 for entry up to 1 x D.

Tool Tip: M233 Rougher end mills show up to 20% power reduction from M223 in the same cut.

- D** Tool Diameter
- Z** Number of Flutes
- RPM** Revolutions per Minute
- SFM** Surface Feet per Minute
- M/min** Surface Meters per Minute
- IPM** Inches per Minute
- MMPM** Millimeters per Minute
- IPT** Inch per Tooth
- MMPT** Millimeters per Tooth
- MRR** Metal Removal Rate
- RDOC** Radial Depth of Cut
- ADOC** Axial Depth of Cut

Technical Resources

Information on tips and adjustments for the following milling operations can be found in our Technical Resources section beginning on page 134.

- HEM slotting
- Face milling
- Helical entry ramping
- Straight line ramping
- Long tool projection adjustments
- Ball nose milling adjustments
- Other helpful tips and calculations

M203 STREAKERS



For high-performance machining in aluminum alloys. Unique grinds curl and evacuate gummy aluminum chips, allowing high feed rates without clogging. Excellent tool life. The 3-flute design yields a superior finish.

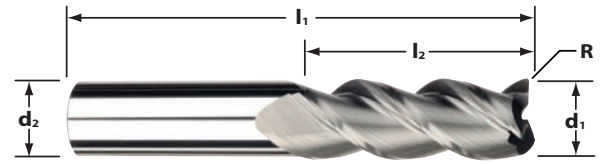

in: d1: -0.0001 / -0.0004 d2: -0.0001 / -0.0004
mm: d1: -0.0025 / -0.0100 d2: -0.0025 / -0.0100



Cutter Dia d1	Shank Dia d2	Length of Cut l2	Overall Length l1	Order Code SQ	Order Code by Corner Radius			
					.015 CR	.030 CR	.060 CR	.125 CR
1/8	1/8	1/4	1-1/2	0332884	-	-	-	-
		3/8	1-1/2	0333152	0333504	-	-	-
3/16	3/16	5/16	2	0332885	-	-	-	-
		9/16	2	0333153	0333505	-	-	-
1/4	1/4	3/8	2-1/2	0333017	0333206	-	-	-
		3/4	2-1/2	0333023	0333506	0333508	-	-
		1-1/4	3	0333038	0333534	0333537	-	-
5/16	5/16	13/16	2-1/2	0333154	-	-	-	-
		1-3/8	3	0333550	-	-	-	-
3/8	3/8	1/2	2-1/2	0333019	-	-	-	-
		1	2-1/2	0333024	0333553	0333555	0334249	-
		1-1/2	3-1/4	0333029	0333557	0333560	0334250	-
		2	4	0333033	-	-	-	-
1/2	1/2	5/8	3	0333020	-	0333216	-	0333219
		1-1/4	3	0333025	0333566	0333584	0333587	0334037
		2	4	0333030	0333590	0333593	0333596	0334044
		2-1/2	5	0333034	-	-	-	-
5/8	5/8	3-1/8	6	0333042	-	-	-	-
		1-5/8	3-1/2	0333026	-	0333604	-	-
3/4	3/4	2-1/2	5	0333035	-	0333607	-	-
		1	4	0333022	-	0333220	-	0333225
		1-5/8	4	0333027	-	0333611	-	0334039
		2-1/2	5	0333031	-	0333616	-	0334047
1	1	3-1/4	6	0333036	-	0333618	-	-
		1-1/4	4	0333115	-	-	-	-
		2	4	0333028	-	-	-	-
		2-5/8	5	0333032	-	-	-	-
3-1/4	3-1/4	6	0333037	-	-	-	-	
		4-1/8	7	0333041	-	-	-	-

Cutter Dia d1	Shank Dia d2	Length of Cut l2	Overall Length l1	Order Code SQ
3	3	5	38	0332886
4	4	11	50	0333137
5	5	13	50	0333138
6	6	16	57	0333139
		29	75	0333454
8	8	19	63	0333140
		29	75	0333455
10	10	22	72	0333141
		40	88	0333462
12	12	26	83	0333142
		50	100	0333456
16	16	32	92	0333144
		57	125	0333457
20	20	38	104	0333145
		57	125	0333458

M203_{w/WELDON} STREAKERS

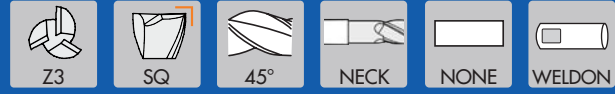

For high-performance machining in aluminum alloys. Unique grinds curl and evacuate gummy aluminum chips, allowing high feed rates without clogging. Excellent tool life. The 3-flute design yields a superior finish.

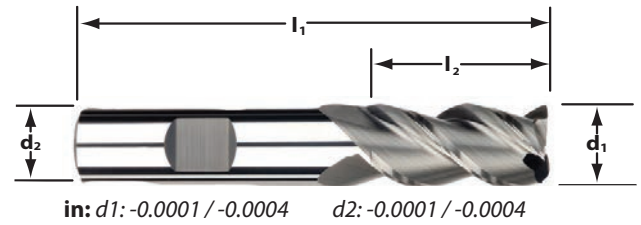

Cutter Dia d1	Shank Dia d2	Length of Cut I2	Overall Length I1	Order Code SQ
1/4	1/4	3/4	2-1/2	0332928
		1-1/4	3	0333040
3/8	3/8	7/8	2-1/2	0332929
		1-1/2	3-1/4	0332936
1/2	1/2	1-1/4	3-1/4	0332930
		2	4	0332937
5/8	5/8	1-1/4	3-1/2	0332931
		2-1/2	5	0332946
3/4	3/4	1-5/8	4	0332932
		2-1/2	5	0332938
1	1	2	4-1/2	0332935
		2-5/8	5	0332943
		3-1/4	6	0332948

Cutter Dia d1	Shank Dia d2	Length of Cut I2	Reach LBS I3	Overall Length I1	Order Code SQ
1/4	1/4	3/8	1-1/8	2-1/2	0333061
			1-5/8	3	0333102
			2-1/4	4	0333094
3/8	3/8	1/2	1-1/8	2-1/2	0333062
			1-3/4	3	0333103
			2-1/4	4	0333095
1/2	1/2	5/8	1-3/8	3	0333063
			2-1/4	4	0333104
			2-3/8	5	0333097
			3-3/8	6	0333073
5/8	5/8	3/4	1-1/2	3-1/2	0333064
			2-1/4	5	0333105
			3-3/8	6	0333099
3/4	3/4	1	1-3/4	4	0333065
			2-1/4	5	0333106
			3-3/8	6	0333100

M203N

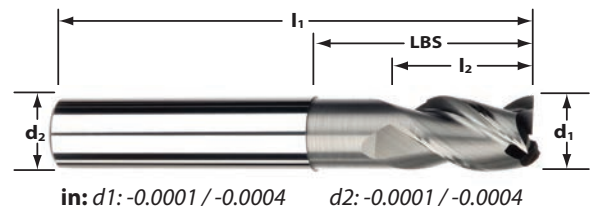

For high-performance machining in aluminum alloys. Adding a necked shank to the M203 design offers a high-performance tool that permits clearance in deeper cavities and easier machining against tight walls. Neck relief and short flute length combine to increase end mill stability in the cut for more precise tolerances. Great for work in pockets.

M202 STREAKERS



For high-performance machining in aluminum alloys. Unique grinds curl and evacuate gummy aluminum chips, allowing high feed rates without clogging. The 2-flute design increases the chip evacuation area, allowing more tool engagement. Excellent tool life.

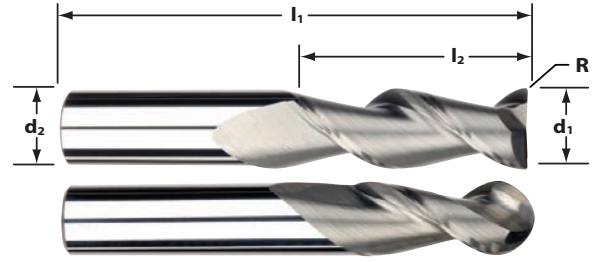

in: d1: -0.0001 / -0.0004 d2: -0.0001 / -0.0004
mm: d1: +0.000 / -0.050 d2: -0.0025 / -0.0100

Cutter Dia d1	Shank Dia d2	Length of Cut l2	Overall Length l1	Order Code SQ	Order Code by Corner Radius				Order Code BN
					.015 CR	.030 CR	.060 CR	.125 CR	
1/8	1/8	1/4	1-1/2	0332975	-	-	-	-	-
		3/8	1-1/2	0332983	0333183	-	-	-	0333175
3/16	3/16	5/16	2	0332976	-	-	-	-	-
		9/16	2	0332984	0333186	-	-	-	0333176
1/4	1/4	3/8	2-1/2	0332977	-	-	-	-	-
		3/4	2-1/2	0332985	0333187	0333189	-	-	0333011
		1-1/4	3	0332991	0333191	0333502	-	-	-
5/16	5/16	13/16	2-1/2	0332986	-	-	-	-	0333012
		1-3/8	3	0332992	-	-	-	-	-
3/8	3/8	1/2	2-1/2	0332979	-	-	-	-	-
		1	2-1/2	0332987	0333238	0333240	-	-	0333013
		1-1/2	3-1/4	0332993	0333243	0333283	-	-	-
		2	4	0332997	0333344	0333378	-	-	-
1/2	1/2	5/8	3	0332980	-	-	-	-	-
		1-1/4	3	0338030	0333380	0333387	0333401	0334087	0333014
		2	4	0332994	0333403	0333405	0333407	0334092	-
5/8	5/8	2-1/2	5	0332998	-	0333428	-	-	-
		1-5/8	3-1/2	0332988	-	0333430	0334347	0334349	0333015
		2-1/2	5	0332999	-	0333433	-	-	-
3/4	3/4	3-3/4	6	0334356	-	0334358	-	-	-
		1-5/8	4	0332989	-	0333435	0333438	0334089	0333016
		2-1/2	5	0332995	-	0333482	0334093	0334095	-
		3-1/4	6	0333000	-	0333484	-	0334101	-

Cutter Dia d1	Shank Dia d2	Length of Cut l2	Overall Length l1	Order Code SQ	Order Code BN
3	3	5	38	0333002	-
		8	38	-	0335237
4	4	11	50	0333775	0335238
5	5	13	50	0333777	0335246
6	6	16	57	0335239	0335247
8	8	19	63	0335240	0335248
10	10	22	72	0335241	0335249
12	12	26	83	0335242	0335251
16	16	32	92	0335244	0335252
20	20	38	104	0335245	0335253

M202^{w/WELDON} STREAKERS



For high-performance machining in aluminum alloys. Unique grinds curl and evacuate gummy aluminum chips, allowing high feed rates without clogging. The 2-flute design increases the chip evacuation area, allowing more tool engagement. Excellent tool life.

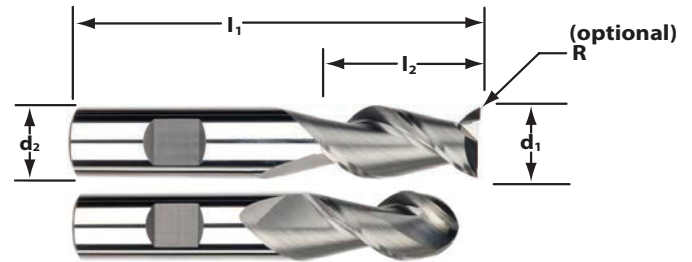

in: d1: -0.0001 / -0.0004 d2: -0.0001 / -0.0004



Cutter Dia d1	Shank Dia d2	Length of Cut I2	Overall Length I1	Order Code SQ	Order Code by Corner Radius			Order Code BN
					.015 CR	.030 CR	.060 CR	
1/4	1/4	3/4	2-1/2	0332864	0333188	0333190	-	0332913
		1-1/4	3	0332869	-	-	-	-
5/16	5/16	13/16	2-1/2	0332865	-	-	-	0332914
		1-3/8	3	0332870	-	-	-	-
3/8	3/8	7/8	2-1/2	0332866	0333239	0333241	0333242	0332915
		1-1/2	3-1/4	0332871	-	-	-	-
		2	4	0332879	-	-	-	-
1/2	1/2	1	3	0332867	-	-	-	-
		1-1/4	3-1/4	0332924	0333381	0333388	0333402	0332916
		2	4	0332872	0333404	0333406	0333408	-
		2-1/2	5	0332880	-	-	-	-
5/8	5/8	1-1/4	3-1/2	0332868	-	-	-	0332917
		2-1/2	5	0332881	-	-	-	-
3/4	3/4	1-5/8	4	0332876	-	0333436	-	0332925
		2-1/2	5	0332877	-	0333483	-	-
		3-1/4	6	0332882	-	-	-	-

Cutter Dia d1	Shank Dia d2	Length of Cut I2	Reach LBS I3	Overall Length I1	Order Code SQ
1/4	1/4	3/8	1-1/8	2-1/2	0332969
			1-5/8	3	0333044
			2-1/4	4	0333050
3/8	3/8	1/2	1-1/8	2-1/2	0332970
			1-3/4	3	0333045
1/2	1/2	5/8	2-1/4	4	0333051
			1-3/8	3	0332971
			2-1/4	4	0333046
5/8	5/8	3/4	2-3/8	5	0333052
			3-3/8	6	0333059
			1-1/2	3-1/2	0856228
3/4	3/4	1	2-1/4	5	0333047
			3-3/8	6	0333053
			1-3/4	4	0332973
3/4	3/4	1	2-1/4	5	0333048
			3-3/8	6	0333054

M202N

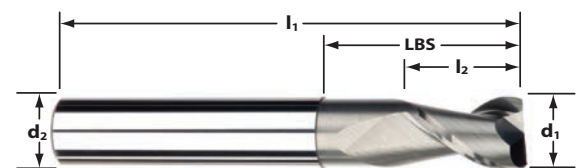

in: d1: -0.0001 / -0.0004 d2: -0.0001 / -0.0004

For high-performance machining in aluminum alloys. Adding a necked shank to the M202 design offers a high-performance tool that permits clearance in deeper cavities and easier machining against tight walls. Neck relief and short flute length combine to increase end mill stability in the cut for more precise tolerances. Great for work in pockets.

M203/M202 Series Application Guide – Speed & Feed (inch)

ISO Code	Work Material	Type of Cut	Axial DOC	Radial DOC	Number of Flutes	Speed (SFM)	Feed (Inch per Tooth)								
							1/8	3/16	1/4	5/16	3/8	1/2	5/8	3/4	1
N	Aluminum Alloys 2024, 6061, 7075	Slotting	1 x D	1 x D	2	800	.0015	.0023	.0030	.0038	.0045	.0060	.0075	.0090	.0120
		Peripheral - Rough	1 x D	.75 x D	2	1000	.0019	.0028	.0038	.0047	.0056	.0075	.0094	.0113	.0150
		Peripheral - Finish	1.5 x D	.01 x D	2	1200	.0024	.0035	.0047	.0059	.0071	.0094	.0118	.0141	.0188
	High Silicon Aluminum A380, A390	Slotting	.75 x D	1 x D	2	500	.0013	.0020	.0026	.0033	.0039	.0052	.0065	.0078	.0104
		Peripheral - Rough	1 x D	.5 x D	2	700	.0016	.0024	.0033	.0041	.0049	.0065	.0081	.0098	.0130
		Peripheral - Finish	1.5 x D	.01 x D	2	900	.0020	.0031	.0041	.0051	.0061	.0082	.0102	.0122	.0163
	Magnesium Alloys	Slotting	1 x D	1 x D	2	800	.0015	.0023	.0030	.0038	.0045	.0060	.0075	.0090	.0120
		Peripheral - Rough	1 x D	.75 x D	2	1000	.0019	.0028	.0038	.0047	.0056	.0075	.0094	.0113	.0150
		Peripheral - Finish	1.5 x D	.01 x D	2	1200	.0024	.0035	.0047	.0059	.0071	.0094	.0118	.0141	.0188
	Copper Alloys Brass, Bronze	Slotting	.75 x D	1 x D	2	500	.0013	.0020	.0026	.0033	.0039	.0052	.0065	.0078	.0104
		Peripheral - Rough	1 x D	.75 x D	2	575	.0016	.0024	.0033	.0041	.0049	.0065	.0081	.0098	.0130
		Peripheral - Finish	1.5 x D	.01 x D	2	650	.0020	.0031	.0041	.0051	.0061	.0082	.0102	.0122	.0163
Composites Plastics, Fiberglass	Slotting	1 x D	1 x D	2	500	.0013	.0020	.0026	.0033	.0039	.0052	.0065	.0078	.0104	
	Peripheral - Rough	1 x D	.75 x D	2	700	.0016	.0024	.0033	.0041	.0049	.0065	.0081	.0098	.0130	
	Peripheral - Finish	1.5 x D	.01 x D	2	900	.0020	.0031	.0041	.0051	.0061	.0082	.0102	.0122	.0163	
Aluminum Alloys 2024, 6061, 7075	Slotting	.75 x D	1 x D	3	800	.0013	.0020	.0026	.0033	.0039	.0052	.0065	.0078	.0104	
	Peripheral - Rough	1 x D	.75 x D	3	1000	.0016	.0024	.0033	.0041	.0049	.0065	.0081	.0098	.0130	
	Peripheral - Finish	1.5 x D	.01 x D	3	1200	.0020	.0031	.0041	.0051	.0061	.0082	.0102	.0122	.0163	
High Silicon Aluminum A380, A390	Slotting	.5 x D	1 x D	3	500	.0011	.0017	.0022	.0028	.0033	.0044	.0055	.0066	.0088	
	Peripheral - Rough	1 x D	.5 x D	3	700	.0014	.0021	.0028	.0034	.0041	.0055	.0069	.0083	.0110	
	Peripheral - Finish	1.5 x D	.01 x D	3	900	.0017	.0026	.0035	.0043	.0052	.0069	.0086	.0104	.0138	
Magnesium Alloys	Slotting	.75 x D	1 x D	3	800	.0013	.0020	.0026	.0033	.0039	.0052	.0065	.0078	.0104	
	Peripheral - Rough	1 x D	.75 x D	3	1000	.0016	.0024	.0033	.0041	.0049	.0065	.0081	.0098	.0130	
	Peripheral - Finish	1.5 x D	.01 x D	3	1200	.0020	.0031	.0041	.0051	.0061	.0082	.0102	.0122	.0163	
Copper Alloys Brass, Bronze	Slotting	.75 x D	1 x D	3	500	.0011	.0017	.0022	.0028	.0033	.0044	.0055	.0066	.0088	
	Peripheral - Rough	1 x D	.75 x D	3	575	.0014	.0021	.0028	.0034	.0041	.0055	.0069	.0083	.0110	
	Peripheral - Finish	1.5 x D	.01 x D	3	650	.0017	.0026	.0035	.0043	.0052	.0069	.0086	.0104	.0138	
Composites Plastics, Fiberglass	Slotting	1 x D	1 x D	3	500	.0011	.0017	.0022	.0028	.0033	.0044	.0055	.0066	.0088	
	Peripheral - Rough	1 x D	.75 x D	3	700	.0014	.0021	.0028	.0034	.0041	.0055	.0069	.0083	.0110	
	Peripheral - Finish	1.5 x D	.01 x D	3	900	.0017	.0026	.0035	.0043	.0052	.0069	.0086	.0104	.0138	

D = Tool Diameter

≈ Approximately Equals < Less Than
 ≤ Less Than or Equal To > Greater Than
 ≥ Greater Than or Equal To = Equals
 × Multiply

Common Machining Formulas

$$RPM = \frac{SFM \times 3.82}{D}$$

$$SFM = RPM \times D \times .262$$

$$IPM = RPM \times IPT \times Z$$

$$MRR = RDOC \times ADOC \times IPM$$

$$RPM = \frac{M/min \times 318.3}{D}$$

$$M/min = RPM \times D \times .00314$$

$$MMPM = RPM \times MMPT \times Z$$

$$MRR = RDOC \times ADOC \times MMPM$$

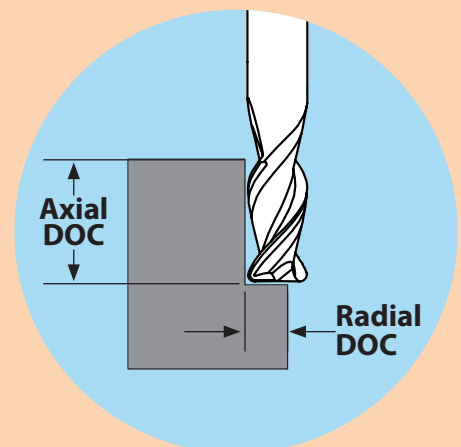

M203/M202 Series Application Guide – Speed & Feed (metric)

ISO Code	Work Material	Type of Cut	Axial DOC	Radial DOC	Number of Flutes	Speed (M/Min)	Feed (MM per Tooth)								
							3.0	4.0	5.0	6.0	8.0	10.0	12.0	16.0	20.0
N	Aluminum Alloys 2024, 6061, 7075	Slotting	1 x D	1 x D	2	244	.0360	.0480	.0600	.0720	.0960	.1195	.1440	.1915	.2405
		Peripheral - Rough	1 x D	.75 x D	2	305	.0450	.0600	.0750	.0900	.1200	.1494	.1800	.2394	.3006
		Peripheral - Finish	1.5 x D	.01 x D	2	365	.0565	.0754	.0942	.1131	.1508	.1877	.2261	.3007	.3776
	High Silicon Aluminum A380, A390	Slotting	.75 x D	1 x D	2	153	.0312	.0416	.0520	.0624	.0832	.1036	.1248	.1660	.2084
		Peripheral - Rough	1 x D	.5 x D	2	213	.0390	.0520	.0650	.0780	.1040	.1295	.1560	.2075	.2605
		Peripheral - Finish	1.5 x D	.01 x D	2	274	.0490	.0653	.0817	.0980	.1307	.1627	.1960	.2606	.3273
	Magnesium Alloys	Slotting	1 x D	1 x D	2	244	.0360	.0480	.0600	.0720	.0960	.1195	.1440	.1915	.2405
		Peripheral - Rough	1 x D	.75 x D	2	305	.0450	.0600	.0750	.0900	.1200	.1494	.1800	.2394	.3006
		Peripheral - Finish	1.5 x D	.01 x D	2	365	.0565	.0754	.0942	.1131	.1508	.1877	.2261	.3007	.3776
	Copper Alloys Brass, Bronze	Slotting	.75 x D	1 x D	2	153	.0312	.0416	.0520	.0624	.0832	.1036	.1248	.1660	.2084
		Peripheral - Rough	1 x D	.75 x D	2	175	.0390	.0520	.0650	.0780	.1040	.1295	.1560	.2075	.2605
		Peripheral - Finish	1.5 x D	.01 x D	2	198	.0490	.0653	.0817	.0980	.1307	.1627	.1960	.2606	.3273
	Composites Plastics, Fiberglass	Slotting	1 x D	1 x D	2	153	.0312	.0416	.0520	.0624	.0832	.1036	.1248	.1660	.2084
		Peripheral - Rough	1 x D	.75 x D	2	213	.0390	.0520	.0650	.0780	.1040	.1295	.1560	.2075	.2605
		Peripheral - Finish	1.5 x D	.01 x D	2	274	.0490	.0653	.0817	.0980	.1307	.1627	.1960	.2606	.3273
	Aluminum Alloys 2024, 6061, 7075	Slotting	.75 x D	1 x D	3	244	.0312	.0416	.0520	.0624	.0832	.1036	.1248	.1660	.2084
		Peripheral - Rough	1 x D	.75 x D	3	305	.0390	.0520	.0650	.0780	.1040	.1295	.1560	.2075	.2605
		Peripheral - Finish	1.5 x D	.01 x D	3	365	.0490	.0653	.0817	.0980	.1307	.1627	.1960	.2606	.3273
	High Silicon Aluminum A380, A390	Slotting	.5 x D	1 x D	3	153	.0264	.0352	.0440	.0528	.0704	.0876	.1056	.1404	.1763
		Peripheral - Rough	1 x D	.5 x D	3	213	.0330	.0440	.0550	.0660	.0880	.1096	.1320	.1755	.2204
		Peripheral - Finish	1.5 x D	.01 x D	3	274	.0415	.0553	.0691	.0829	.1106	.1376	.1658	.2205	.2769
	Magnesium Alloys	Slotting	.75 x D	1 x D	3	244	.0312	.0416	.0520	.0624	.0832	.1036	.1248	.1660	.2084
		Peripheral - Rough	1 x D	.75 x D	3	305	.0390	.0520	.0650	.0780	.1040	.1295	.1560	.2075	.2605
		Peripheral - Finish	1.5 x D	.01 x D	3	365	.0490	.0653	.0817	.0980	.1307	.1627	.1960	.2606	.3273
Copper Alloys Brass, Bronze	Slotting	.75 x D	1 x D	3	153	.0264	.0352	.0440	.0528	.0704	.0876	.1056	.1404	.1763	
	Peripheral - Rough	1 x D	.75 x D	3	175	.0330	.0440	.0550	.0660	.0880	.1096	.1320	.1755	.2204	
	Peripheral - Finish	1.5 x D	.01 x D	3	198	.0415	.0553	.0691	.0829	.1106	.1376	.1658	.2205	.2769	
Composites Plastics, Fiberglass	Slotting	1 x D	1 x D	3	153	.0264	.0352	.0440	.0528	.0704	.0876	.1056	.1404	.1763	
	Peripheral - Rough	1 x D	.75 x D	3	213	.0330	.0440	.0550	.0660	.0880	.1096	.1320	.1755	.2204	
	Peripheral - Finish	1.5 x D	.01 x D	3	274	.0415	.0553	.0691	.0829	.1106	.1376	.1658	.2205	.2769	

D = Tool Diameter

- D** Tool Diameter
- Z** Number of Flutes
- RPM** Revolutions per Minute
- SFM** Surface Feet per Minute
- M/min** Surface Meters per Minute
- IPM** Inches per Minute
- MMPM** Millimeters per Minute
- IPT** Inch per Tooth
- MMPT** Millimeters per Tooth
- MRR** Metal Removal Rate
- RDOC** Radial Depth of Cut
- ADOC** Axial Depth of Cut

Technical Resources

Information on tips and adjustments for the following milling operations can be found in our Technical Resources section beginning on page 134.

- HEM slotting
- Face milling
- Helical entry ramping
- Straight line ramping
- Long tool projection adjustments
- Ball nose milling adjustments
- Other helpful tips and calculations

truCORE[®]

**GENERAL PURPOSE
DOES NOT MEAN
"SECOND CLASS."**

IMCO's truCORE series of end mills are all made from high-grade substrate and are ground to strict standards — making our base tools outstanding in their class.



truCORE Features

BETTER PRECISION, LONGER TOOL LIFE BY DESIGN.

Optimized flute designs and a high-strength core give our truCORE E series end mills cutting performance you do not see with conventional general-purpose tools. IMCO's truCORE end mills are CNC ground from the highest quality material, maximizing performance and repeatability.



	E14	E14	E14	E14	E24	E13	E13	E12	M104	E520B
NUMBER OF FLUTES	Z4	Z4	Z4	Z4	Z4	Z3	Z3	Z2	Z4	Z2
END TYPES	SQ CR BN	SQ BN	SQ	SQ BN	SQ BN	SQ BN	SQ	SQ BN	SQ	BN
HELIX ANGLE	30°	30°	30°	30°	30°	30°	30°	30°	30°	15°
COATING	AlTiN	TiCN	TiN	NONE	AlTiN	AlTiN	NONE	AlTiN NONE	AlTiN	AlTiN
SHANK TYPES	PLAIN WELDON	PLAIN WELDON	PLAIN	PLAIN WELDON	PLAIN	PLAIN	PLAIN	PLAIN	PLAIN	PLAIN NECK
APPLICATIONS	ROUGH FINISH							ROUGH	ROUGH	ROUGH FINISH
MATERIAL(S)	K P M S N								P M	H

E14 AlTiN truCORE



For general machining in a wide range of materials. The E14 offers the most cutting edges in a general-purpose tool design. Best for roughing and finishing in a broad range of machining environments. The AlTiN coating offers superior heat resistance and hardness for increased tool life.

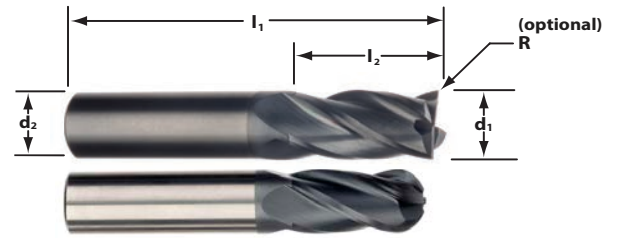

in: $d1: +0.000 / -0.002$ $d2: -0.0001 / -0.0004$

Cutter Dia d1	Shank Dia d2	Length of Cut l2	Overall Length l1	Order Code SQ	Order Code by Corner Radius					Order Code BN
					.015 CR	.020 CR	.030 CR	.045 CR	.060 CR	
1/32	1/8	3/32	1-1/2	0338094	-	-	-	-	-	0332180
3/64	1/8	9/64	1-1/2	0332170	-	-	-	-	-	0332171
1/16	1/8	1/8	1-1/2	0332165	-	-	-	-	-	0332166
		3/16	1-1/2	0332300	-	-	-	-	-	0338066
		1/4	1-1/2	0338039	-	-	-	-	-	-
5/64	1/8	1/4	1-1/2	0332150	-	-	-	-	0332131	
3/32	1/8	3/16	1-1/2	0332548	-	-	-	-	-	0332570
		3/8	1-1/2	0332167	-	-	-	-	-	0332386
7/64	1/8	3/8	1-1/2	0332117	-	-	-	-	-	
1/8	1/8	1/4	1-1/2	0338067	-	-	-	-	-	0332603
		1/2	1-1/2	0332159	0338057	0338032	-	-	-	0332391
		5/8	2	0335145	-	-	-	-	-	0333984
		3/4	2-1/4	0332111	-	-	-	-	-	0333992
		1	3	0338064	-	-	-	-	-	0338060
9/64	3/16	9/16	2	0332145	-	-	-	-	-	
5/32	3/16	5/16	2	0334619	-	-	-	-	-	0332122
		9/16	2	0332146	-	-	-	-	-	0332123
11/64	3/16	5/8	2	0332151	-	-	-	-	-	-
		3/8	2	0332550	-	-	-	-	-	0332602
		5/8	2	0332158	0334594	0334595	0334555	-	-	0332161
		3/4	2-1/2	0333948	-	-	-	-	-	0333996
		1	4	0335147	-	-	-	-	-	0333985
13/64	1/4	1-1/8	3	0333355	-	-	-	-	-	0334016
		5/8	2-1/2	0332124	-	-	-	-	-	-
		5/8	2-1/2	0332172	-	-	-	-	-	0332405
15/64	1/4	3/4	2-1/2	0332379	-	-	-	-	-	
1/4	1/4	1/2	2	0332552	-	-	-	-	-	0332601
		3/4	2-1/2	0338077	0332157	0334528	0334557	0334596	-	0332392
		1	4	0335148	-	-	-	-	-	0333986
		1-1/8	3	0338093	-	-	-	-	-	0334000
		1-1/2	4	0338081	-	-	-	-	-	0338049
17/64	5/16	1-1/2	6	0334628	-	-	-	-	-	0338061
		3/4	2-1/2	0332381	-	-	-	-	-	-
		3/4	2-1/2	0338046	-	-	-	-	-	0332121
19/64	5/16	13/16	2-1/2	0332384	-	-	-	-	-	
5/16	5/16	1/2	2	0332169	-	-	-	-	-	0332600
		13/16	2-1/2	0332339	0334597	0334598	0334599	0334600	-	0332162
		1-1/8	3	0332118	-	-	-	-	-	0333471
		1-5/8	4	0333362	-	-	-	-	-	0333496
21/64	3/8	1	2-1/2	0332393	-	-	-	-	-	
11/32	3/8	1	2-1/2	0332120	-	-	-	-	0332108	
23/64	3/8	1	2-1/2	0332394	-	-	-	-	-	-
		5/8	2	0332551	-	-	-	-	-	0332604
		1	2-1/2	0338073	0333854	0333855	0333856	0333857	0333858	0338075
		1-1/8	3	0333930	-	-	-	-	-	0334007
		1-1/2	6	0338065	-	-	-	-	-	-
		1-3/4	4	0333373	-	-	-	-	0333479	

Cutter Dia d1	Shank Dia d2	Length of Cut l2	Overall Length l1	Order Code SQ	Order Code by Corner Radius					Order Code BN
					.015 CR	.020 CR	.030 CR	.045 CR	.060 CR	
25/64	7/16	1	2-3/4	0332395	-	-	-	-	-	-
13/32	7/16	1	2-3/4	0332396	-	-	-	-	-	-
27/64	7/16	1	2-3/4	0332397	-	-	-	-	-	-
7/16	7/16	1	2-3/4	0332403	-	-	-	-	-	0332408
		2	4	0333933	-	-	-	-	-	-
29/64	1/2	1	3	0332128	-	-	-	-	-	-
15/32	1/2	1	3	0332398	-	-	-	-	-	-
31/64	1/2	1	3	0338089	-	-	-	-	-	-
1/2	1/2	5/8	2-1/2	0332549	-	-	-	-	-	0332599
		1	3	0338074	0333860	0333861	0333862	0333863	0333864	0338071
		1-1/2	6	0332430	-	-	-	-	-	-
		2	4	0333937	-	-	-	-	-	0334014
		3	6	0333372	-	-	-	-	-	0332126
9/16	9/16	1-1/4	3-1/2	0332390	-	-	-	-	-	0332109
5/8	5/8	1-1/4	3-1/2	0332177	-	-	-	-	-	0332385
		2-1/4	5	0332182	-	-	-	-	-	-
		3	6	0333377	-	-	-	-	-	-
11/16	3/4	1-1/2	4	0332399	-	-	-	-	-	0332407
3/4	3/4	1-1/2	4	0338078	-	-	-	-	-	0338045
		2-1/4	5	0333944	-	-	-	-	-	-
		3	6	0333385	-	-	-	-	-	-
13/16	7/8	1-1/2	4	0332400	-	-	-	-	-	-
7/8	7/8	1-1/2	4	0332160	-	-	-	-	-	-
15/16	1	1-1/2	4	0332402	-	-	-	-	-	-
1	1	1-1/2	4	0338079	-	-	-	-	-	-
		2-1/4	5	0333947	-	-	-	-	-	-
		3	6	0333392	-	-	-	-	-	-

Cutter Dia d1	Shank Dia d2	Length of Cut l2	Overall Length l1	Order Code SQ
3/8	3/8	1	2-1/2	0334638
		1-1/8	3	0334494
1/2	1/2	1	3	0334639
		2	4	0334495
5/8	5/8	1-1/4	3-1/2	0334641
		2-1/4	5	0334496
		3	6	0334502
3/4	3/4	1-1/2	4	0334642
		2-1/4	5	0334497
		3	6	0334503
1	1	1-1/2	4	0334644
		2-1/4	5	0334498
		3	6	0334513

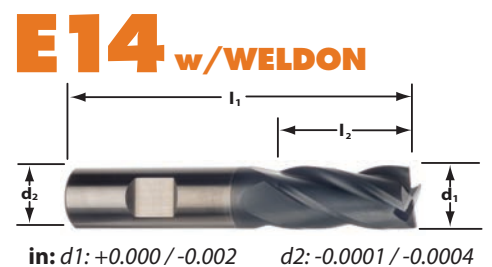

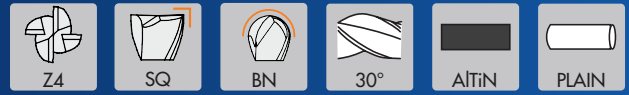

For general machining in a wide range of materials. The E14 offers the most cutting edges in a general-purpose tool design. Best for roughing and finishing in a broad range of machining environments. The AlTiN coating offers superior heat resistance and hardness for increased tool life.

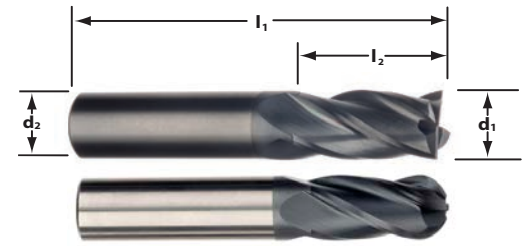

mm: $d1: +0.000 / -0.050$ $d2: -0.0025 / 0.0100$



Cutter Dia d1	Shank Dia d2	Length of Cut l2	Overall Length l1	Order Code SQ	Order Code BN
1	3	2	38	0334611	-
		3	38	0332815	0334653
1.5	3	4,5	38	0332816	0334654
		6	38	0332062	0335308
2	3	6,3	38	0332817	0334655
		9	38	0332063	0335309
2.5	3	5	38	0334612	-
		9,5	38	0332818	0334656
3	3	9	38	0338091	-
		12	38	0332819	0334657
		19	57	0334645	-
		25	75	0332840	0334670
3.5	4	14	50	0332820	-
4	4	14	50	0332821	0334658
		19	63	0334646	-
		31	75	0332841	0334671
5	5	16	50	0332823	0334659
		19	63	0334647	-
		31	75	0332842	-
6	6	13	57	0333742	-
		19	63	0332824	0334660
		29	75	0334648	0334666
		38	100	0332843	0334672
8	8	20	63	0332826	0334661
		29	75	0334649	-
		41	100	0332844	0334673
10	10	25	72	0332828	0334662
		40	88	0333772	-
		45	100	0332845	0334674
12	12	25	76	0332829	0334663
		26	83	0333743	0333830
		50	100	0334650	0334667
		75	150	0332846	-
16	16	32	92	0333744	0334665
		57	125	0334651	0334668
		75	150	0332847	-
20	20	38	104	0333745	0332933
		57	125	0334652	0334669
		75	150	0332848	-
25	25	45	120	0333773	-
		75	150	0332849	-

E14^{TiCN} truCORE



For general machining in a wide range of materials. The E14 offers the most cutting edges in a general-purpose tool design. Best for roughing and finishing in a broad range of machining environments. The TiCN coating protects the cutting edge and increases tool life over uncoated end mills.

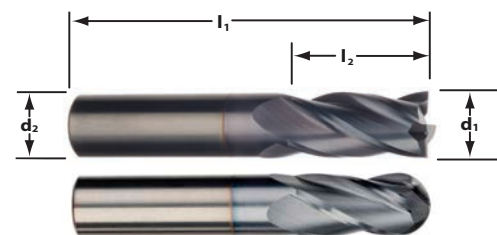

in: $d1: +0.000 / -0.002$ $d2: -0.0001 / -0.0004$



Cutter Dia d1	Shank Dia d2	Length of Cut l2	Overall Length l1	Order Code SQ	Order Code BN
1/32	1/8	3/32	1-1/2	0333510	-
3/64	1/8	9/64	1-1/2	0333511	-
1/16	1/8	3/16	1-1/2	0333512	0333571
3/32	1/8	3/8	1-1/2	0333514	0333573
1/8	1/8	1/4	1-1/2	0332537	-
		1/2	1-1/2	0333516	0333575
		3/4	2-1/4	0333917	-
		1	3	0333351	-
5/32	3/16	9/16	2	0333518	-
3/16	3/16	3/8	2	0332539	-
		5/8	2	0333520	0333579
		1-1/8	3	0333354	-
1/4	1/4	1/2	2	0332541	-
		3/4	2-1/2	0333524	0333581
		1-1/8	3	0333923	-
		1-1/2	4	0333358	-
5/16	5/16	13/16	2-1/2	0333527	-
3/8	3/8	1	2-1/2	0333530	0333586
		1-1/8	3	0333929	-
		1-3/4	4	0333365	-
7/16	7/16	1	2-3/4	0333532	-
1/2	1/2	1	3	0333533	0333591
		2	4	0333936	-
		3	6	0333371	-
5/8	5/8	1-1/4	3-1/2	0333539	0333599
		2-1/4	5	0333940	-
		3	6	0333376	-
3/4	3/4	1-1/2	4	0333544	0333606
		2-1/4	5	0333943	-
		3	6	0333384	-
1	1	1-1/2	4	0333559	-
		2-1/4	5	0333946	-
		3	6	0333391	-

Cutter Dia d1	Shank Dia d2	Length of Cut l2	Overall Length l1	Order Code SQ
3/8	3/8	1	2-1/2	0334632
1/2	1/2	1	3	0334633
5/8	5/8	1-1/4	3-1/2	0334634
3/4	3/4	1-1/2	4	0334635

E14^{w/WELDON}



in: $d1: +0.000 / -0.002$ $d2: -0.0001 / -0.0004$



For general machining in a wide range of materials. The E14 offers the most cutting edges in a general-purpose tool design. Best for roughing and finishing in a broad range of machining environments.

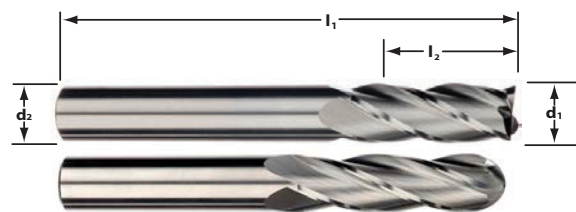

in: d1: +0.000 / -0.002 d2: -0.0001 / -0.0004
mm: d1: +0.000 / -0.050 d2: -0.0025 / -0.0100



Cutter Dia d1	Shank Dia d2	Length of Cut l2	Overall Length l1	Order Code SQ	Order Code BN
1/32	1/8	3/32	1-1/2	0332249	0332342
3/64	1/8	9/64	1-1/2	0332251	-
1/16	1/8	3/16	1-1/2	0332252	0332346
5/64	1/8	1/4	1-1/2	0332254	-
3/32	1/8	3/8	1-1/2	0332256	0332350
7/64	1/8	3/8	1-1/2	0332258	-
1/8	1/8	1/4	1-1/2	0332516	-
		1/2	1-1/2	0332259	0332354
		3/4	2-1/4	0333915	-
5/32	3/16	1	3	0333349	-
3/16	3/16	9/16	2	0332262	-
		3/8	2	0332519	-
		5/8	2	0332265	0332359
		3/4	2-1/2	0333918	-
7/32	1/4	1-1/8	3	0333352	-
		5/8	2-1/2	0332268	-
		1/2	2	0332522	-
1/4	1/4	3/4	2-1/2	0332271	0332363
		1-1/8	3	0333921	-
		1-1/2	4	0333356	-
5/16	5/16	13/16	2-1/2	0332276	-
		1-1/8	3	0333924	-
		1-5/8	4	0333359	-
3/8	3/8	5/8	2	0332526	-
		1	2-1/2	0332278	0332368
		1-1/8	3	0333927	-
7/16	7/16	1-3/4	4	0333363	-
		1	2-3/4	0332295	-
		5/8	2-1/2	0332530	-
1/2	1/2	1	3	0332285	0332371
		2	4	0333934	-
		3	6	0333369	-
5/8	5/8	1-1/4	3-1/2	0332289	0332374
		2-1/4	5	0333938	-
		3	6	0333374	-
3/4	3/4	1-1/2	4	0332293	0332377
		2-1/4	5	0333941	-
		3	6	0333382	-
1	1	1-1/2	4	0332297	-
		2-1/4	5	0856267	-
		3	6	0856263	-

Cutter Dia d1	Shank Dia d2	Length of Cut l2	Overall Length l1	Order Code SQ
1	3	3	38	0332495
1.5	3	6	38	0334410
2	3	6,3	38	0332496
		9	38	0334411
2.5	3	9,5	38	0332497
3	3	12	38	0332498
		19	57	0332044
		25	75	0332025
4	4	14	50	0332500
		19	63	0332045
		31	75	0332026
5	5	16	50	0332502
		19	63	0332046
		31	100	0332049
6	6	19	63	0332503
		29	75	0332027
		38	100	0332050
8	8	20	63	0332505
		29	75	0332028
		41	100	0332051
10	10	25	72	0332507
		40	88	0332034
		45	100	0332029
12	12	25	75	0332508
		50	100	0332030
		75	150	0332031
16	16	32	92	0333739
		57	125	0332047
		75	150	0332032
20	20	38	104	0333740
		57	125	0332048
		75	150	0332033

Cutter Dia d1	Shank Dia d2	Length of Cut l2	Overall Length l1	Order Code SQ
3/8	3/8	1	2-1/2	0334617
1/2	1/2	1	3	0334621
5/8	5/8	1-1/4	3-1/2	0334623
3/4	3/4	1-1/2	4	0334626

E14 w/WELDON

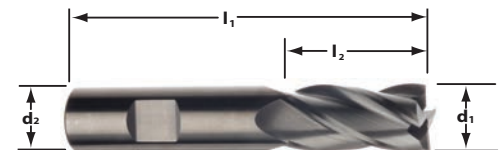

in: d1: +0.000/-0.002 d2: -0.0001/-0.0004



For general machining in a wide range of materials. The E14 offers the most cutting edges in a general tool design. Best for roughing and finishing in a broad range of machining environments. The TiN coating protects the cutting edge and increases tool life over uncoated end mills.

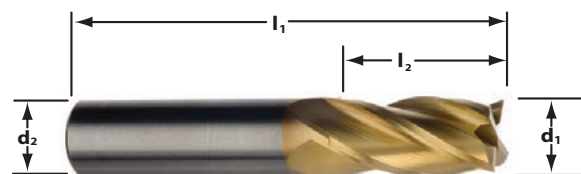

in: $d1: +0.000 / -0.002$ $d2: -0.0001 / -0.0004$



Cutter Dia d1	Shank Dia d2	Length of Cut l2	Overall Length l1	Order Code SQ
1/16	1/8	3/16	1-1/2	0332253
3/32	1/8	3/8	1-1/2	0332257
1/8	1/8	1/2	1-1/2	0332260
3/16	3/16	5/8	2	0332266
1/4	1/4	3/4	2-1/2	0332272
5/16	5/16	13/16	2-1/2	0332277
3/8	3/8	1	2-1/2	0332279
1/2	1/2	1	3	0332286
5/8	5/8	1-1/4	3-1/2	0332290
3/4	3/4	1-1/2	4	0332294

TOOL TIP

Driving Performance to the Edge.

What makes IMCO end mills the best choice for your everyday applications?

Strength: All IMCO truCORE end mills are made using submicron grain carbide with a 10% cobalt binder, increasing the transverse rupture strength for longer durability and even edge wear.

Consistency: IMCO end mills are manufactured on high-precision CNC grinders to exacting standards, ensuring repeatability from tool to tool.

Variety: Many length and dimension options are available in tools with 2-, 3- or 4-flutes—many with high-performance coatings. Weldon flats are available on common sizes.

With all of this, it's easy to see how IMCO tooling can give you maximum performance when working in a wide range of materials.

E24 AlTiN truCORE



For general machining in a wide range of materials. The E24 offers the reliability of our general-purpose tool design in a double-ended form. Best for roughing and finishing in a broad range of machining environments. The AlTiN coating offers superior heat resistance and hardness for increased tool life.

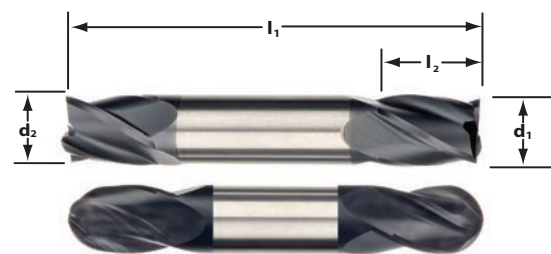

in: d1: +0.000 / -0.002 d2: -0.0001 / -0.0004



Cutter Dia d1	Shank Dia d2	Length of Cut L2	Overall Length L1	Order Code SQ	Order Code BN
1/32	1/8	1/16	1-1/2	0332110	0332752
3/64	1/8	3/32	1-1/2	0332663	0332810
1/16	1/8	1/8	1-1/2	0332720	0332809
5/64	1/8	1/8	1-1/2	0332698	0332753
3/32	1/8	3/16	1-1/2	0332687	0332754
7/64	1/8	3/16	1-1/2	0332702	-
1/8	1/8	1/4	1-1/2	0338090	0332781
9/64	3/16	5/16	2	0332686	-
5/32	3/16	5/16	2	0332725	0332755
11/64	3/16	5/16	2	0332703	-
3/16	3/16	3/8	2	0338092	0332780
7/32	1/4	1/2	2-1/2	0332704	-
1/4	1/4	1/2	2-1/2	0332722	0332779
5/16	5/16	1/2	2-1/2	0332723	0332782
3/8	3/8	9/16	2-1/2	0332689	0332813
1/2	1/2	5/8	3	0332726	0332814



E13 AlTiN truCORE



For general machining in a wide range of materials. The E13 offers a combination of strong cutting edges with increased flute spacing in a general-purpose tool design. Best for roughing and finishing in slots and pockets and in gummy materials. The AlTiN coating offers superior heat resistance and hardness for increased tool life.

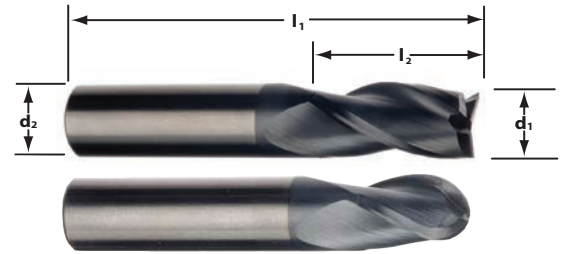

in: d1: +0.000 / -0.002 d2: -0.0001 / -0.0004
mm: d1: +0.000 / -0.050 d2: -0.0025 / -0.0100



Cutter Dia d1	Shank Dia d2	Length of Cut l2	Overall Length l1	Order Code SQ	Order Code BN
1/32	1/8	3/32	1-1/2	0333257	-
3/64	1/8	9/64	1-1/2	0333263	-
1/16	1/8	1/8	1-1/2	0333337	0335123
		3/16	1-1/2	0333266	0335117
3/32	1/8	3/16	1-1/2	0333304	0335124
		3/8	1-1/2	0333267	0335118
1/8	1/8	1/4	1-1/2	0333256	0335125
		1/2	1-1/2	0333259	0335119
		3/4	2-1/4	0333288	0335128
		1	3	0333333	-
5/32	3/16	9/16	2	0333261	-
3/16	3/16	3/8	2	0333338	0335126
		5/8	2	0333271	0335120
		3/4	2-1/2	0333290	0335129
		1-1/8	3	0333334	-
1/4	1/4	1/2	2	0333339	0335127
		3/4	2-1/2	0333272	0335121
		1-1/8	3	0333296	0335130
		1-1/2	4	0333336	0335133
5/16	5/16	13/16	2-1/2	0333273	-
3/8	3/8	1	2-1/2	0333274	0338101
		1-1/8	3	0333297	0335131
1/2	1/2	1	3	0338027	0335122
		2	4	0333300	0335132
5/8	5/8	1-1/4	3-1/2	0333275	-
3/4	3/4	1-1/2	4	0333276	-
		2-1/4	5	0333341	-

TOOL TIP

Aim For a Chip-Free Cutting Zone.

The proper location and volume of flood coolant are essential for a successful cut. Coolant plays a very important part in chip evacuation, especially when machining in a pocket or closed area. But simply blasting a large amount of coolant at the end mill isn't the most effective way to flush chips from the cutting zone. In fact, failure to direct the coolant properly increases the risk of re-cutting chips, causing tool damage and premature wear.

As this series of photos demonstrates, the most productive way to flush chips out of a pocket is to direct the coolant to the bottom of the cut. This allows the coolant to rebound off the tool and part floor, lifting the chips out and away from the tool's cutting edges



Coolant flow is perpendicular to the end mill, flowing past the end mill without hitting it directly. This will not evacuate the chips from the flutes sufficiently or provide proper cooling to the cutting edges.



Coolant flow is hitting the end mill nicely, but it is perpendicular to it. This will cool the end mill but will not lift and flush the chips out of the cutting zone.

Cutter Dia d1	Shank Dia d2	Length of Cut l2	Overall Length l1	Order Code SQ	Order Code BN
1	3	2	38	0332338	-
		3	38	0335255	-
1.5	3	4,5	38	0335256	-
		6	38	0333783	-
2	3	6,3	38	0335257	-
		9	38	0333784	-
2.5	3	9,5	38	0333785	-
3	3	12	38	0332060	0335321
		19	57	0335212	-
		25	75	0335175	-
4	4	14	50	0333786	0335322
		19	63	0335213	-
		31	75	0335176	-
5	5	16	50	0333787	0335323
		19	63	0335214	-
		31	75	0333791	-
6	6	13	57	0333763	-
		19	63	0333788	0332910
		29	75	0335215	-
8	8	20	63	0333789	0332911
		29	75	0335216	-
		41	100	0335177	-
10	10	25	72	0333790	0332912
		40	88	0333800	-
		45	100	0335178	-
12	12	25	75	0333792	-
		26	83	0333764	0333832
		50	100	0335217	-
		75	150	0335179	-
16	16	32	92	0333765	-
		57	125	0335218	-
		75	150	0335180	-
20	20	38	104	0333766	-
		57	125	0335219	-
		75	150	0335181	-



Poor

Coolant volume is weak and too high. The coolant is not aimed into the cutting zone, which limits its effectiveness in flushing the chips, lubricating and cooling at the point of cut.



Good

This example of coolant placement shows plenty of flush at the end mill. The three spray nozzles are pointing down at the end mill, forcing the chips up and out of the cutting zone.



Poor

There is not enough coolant volume to adequately flush chips out of the cutting zone. This condition will result in re-cutting of chips and premature tool wear.



Best

The best coolant flush for evacuating chips from a pocket uses a coolant flush-type collet and through-spindle coolant (if your machine is equipped with it). Coolant is forced all around the end mill – 360° – at high pressure. High-pressure coolant hits the bottom of the cut and lifts the chips out and away from the cutting zone quickly and efficiently.



For general machining in a wide range of materials. The E13 offers a combination of strong cutting edges with increased flute spacing in a general-purpose tool design. Best for roughing and finishing in slots and pockets and in gummy materials.

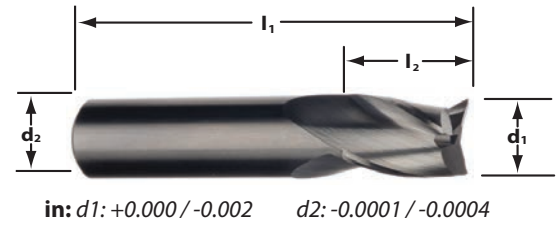

Cutter Dia d1	Shank Dia d2	Length of Cut I2	Overall Length I1	Order Code SQ
1/8	1/8	1/4	1-1/2	0333245
		1/2	1-1/2	0333258
		3/4	2-1/4	0333248
		1	3	0333254
3/16	3/16	3/8	2	0333246
		5/8	2	0333260
		3/4	2-1/2	0333249
		1-1/8	3	0333255
1/4	1/4	1/2	2	0333247
		3/4	2-1/2	0333262
		1-1/8	3	0333250
5/16	5/16	13/16	2-1/2	0333264
3/8	3/8	1	2-1/2	0333265
		1-1/8	3	0333251
1/2	1/2	1	3	0333268
		2	4	0333252
5/8	5/8	1-1/4	3-1/2	0333269
3/4	3/4	1-1/2	4	0333270
		2-1/4	5	0333253

TOOL TIP

Tool Modifications.

Special tooling requirements can often be met through one or more of these simple modifications of standard, off-the-shelf products.

- Add corner radius or chamfer (Note that corners on some series cannot be modified)
- Add a Weldon flat to tool shank
- Add a neck relief
- Shorten flute length
- Add a drill point to an end mill

These coatings can also be added to existing uncoated products.

AlTiNX	TiN
AlTiN	ZrN
AlCrNX	taC
TiCN	DLC (Diamond-Like Coating)

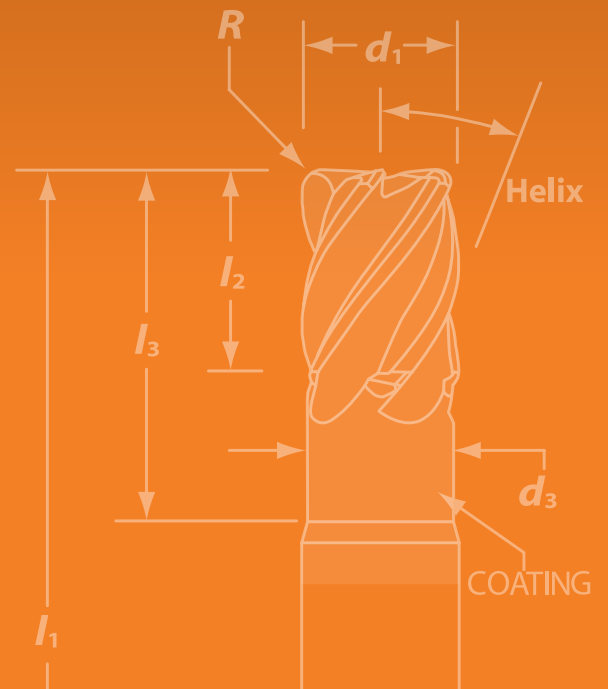





For general machining in a wide range of materials. The E12 offers the maximum flute spacing in a general-purpose tool design. Best for roughing, slotting and pocketing in materials and in applications in which chip evacuation is a challenge. The AlTiN coating offers superior heat resistance and hardness for increased tool life.

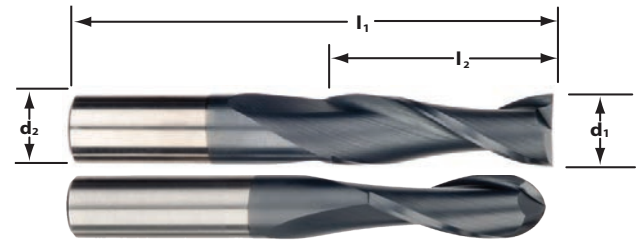

in: $d1: +0.000 / -0.002$ $d2: -0.0001 / -0.0004$
mm: $d1: +0.000 / -0.050$ $d2: -0.0025 / -0.0100$



Cutter Dia d1	Shank Dia d2	Length of Cut l2	Overall Length l1	Order Code SQ	Order Code BN
1/32	1/8	1/16	1-1/2	0334422	0332090
		3/32	1-1/2	0332152	0332070
3/64	1/8	3/32	1-1/2	0334465	0332091
		9/64	1-1/2	0333738	0332069
1/16	1/8	1/8	1-1/2	0334466	0332092
		3/16	1-1/2	0332072	0332114
5/64	1/8	1/4	1-1/2	0332073	0332079
3/32	1/8	3/16	1-1/2	0334467	0332093
		3/8	1-1/2	0332074	0332080
7/64	1/8	3/8	1-1/2	0332075	-
1/8	1/8	1/4	1-1/2	0338026	0332701
		1/2	1-1/2	0338048	0332387
		3/4	2-1/4	0333748	0332096
		1	3	0333307	0332446
9/64	3/16	9/16	2	0332076	-
5/32	3/16	9/16	2	0332147	0332082
11/64	3/16	5/8	2	0332077	-
3/16	3/16	3/8	2	0334479	0332094
		5/8	2	0332176	0338025
		3/4	2-1/2	0333749	0332097
		1-1/8	3	0333313	0338023
13/64	1/4	5/8	2-1/2	0338069	-
7/32	1/4	5/8	2-1/2	0332078	0332083
15/64	1/4	3/4	2-1/2	0332153	-
1/4	1/4	1/2	2	0334484	0332184
		3/4	2-1/2	0332175	0332388
		1-1/8	3	0333751	0332098
		1-1/2	4	0333323	0338024
5/16	5/16	13/16	2-1/2	0332179	0332183
		1-1/8	3	0333750	0332017
		1-5/8	4	0333324	-
3/8	3/8	1	2-1/2	0332178	0332389
		1-1/8	3	0333752	0332099
		1-3/4	4	0333325	0332448
1/2	1/2	1	3	0332174	0338070
		2	4	0333753	0332101
		3	6	0333327	-
5/8	5/8	1-1/4	3-1/2	0332168	-
		2-1/4	5	0333754	-
3/4	3/4	1-1/2	4	0332248	-
		2-1/4	5	0333755	-

Cutter Dia d1	Shank Dia d2	Length of Cut l2	Overall Length l1	Order Code SQ	Order Code BN
1	3	2	38	0335220	-
		3	38	0338083	0338084
1.5	3	4,5	38	0335254	0335258
		6	38	0334026	0335310
2	3	6,3	38	0338085	0338086
		9	38	0334027	0335311
2.5	3	9,5	38	0334028	-
		12	38	0332919	0332918
3	3	19	57	0335188	0335324
		25	75	0335182	0335332
		14	50	0338096	0332920
4	4	19	63	0335189	0335325
		31	75	0335183	0335333
		16	50	0332922	0338087
5	5	19	63	0335190	0335326
		31	75	0332927	-
		13	57	0333760	-
6	6	19	63	0334030	0335315
		29	75	0335191	0335327
		38	100	0335184	0335335
8	8	20	63	0332511	0338088
		29	75	0335192	0335328
		41	100	0335185	-
10	10	25	72	0338097	0335318
		40	88	0333802	0333878
		45	100	0335186	-
12	12	25	75	0338098	0338095
		26	83	0333761	-
		50	100	0335193	0335329
		75	150	0335187	-

TOOL RENEWAL SERVICES

Resharpen. Restore. Recharge.

Get the most out of your tooling investment by utilizing IMCO's reconditioning services. Reconditioning is a cost-effective way to increase the life span and value of your IMCO end mills.

- No quantity limit
- 2- to 3-week turnaround upon order confirmation (coating included) on most tools
- Original coating put back on all IMCO end mills

Contact us with questions or for a quote for our resharpening services at regrinds@imcousa.com. You can also find our order form on our website at imcousa.com/resources/catalog.





For general machining in a wide range of materials. The E12 offers the maximum flute spacing in a general-purpose tool design. Best for roughing, slotting, and pocketing in materials and in applications in which chip evacuation is a challenge.

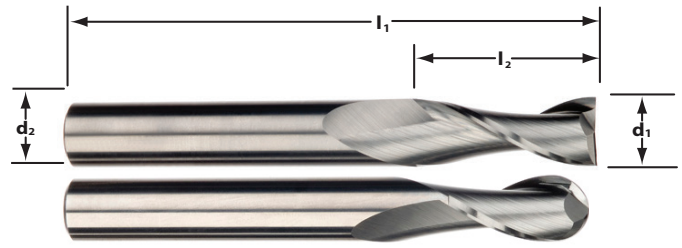

in: $d1: +0.000 / -0.002$ $d2: -0.0001 / -0.0004$
mm: $d1: +0.000 / -0.050$ $d2: -0.0025 / -0.0100$



Cutter Dia d1	Shank Dia d2	Length of Cut l2	Overall Length l1	Order Code SQ	Order Code BN
1/32	1/8	3/32	1-1/2	0332199	0332301
3/64	1/8	9/64	1-1/2	0332201	0332303
1/16	1/8	3/16	1-1/2	0332203	0332304
5/64	1/8	1/4	1-1/2	0332205	0332306
3/32	1/8	3/8	1-1/2	0332207	0332308
7/64	1/8	3/8	1-1/2	0332209	0332310
1/8	1/8	1/4	1-1/2	0332464	0332558
		1/2	1-1/2	0332211	0332311
		3/4	2-1/4	0333894	0333949
		1	3	0333301	0333409
5/32	3/16	9/16	2	0332214	0332314
3/16	3/16	3/8	2	0332466	-
		5/8	2	0332217	0332316
		3/4	2-1/2	0333897	0333952
		1-1/8	3	0333305	0333412
1/4	1/4	1/2	2	0332468	-
		3/4	2-1/2	0332223	0332319
		1-1/8	3	0333899	0333955
		1-1/2	4	0333308	0333415
		1-1/2	6	0332409	0332445
5/16	5/16	1/2	2	0332470	-
		13/16	2-1/2	0332228	0332322
		1-1/8	3	0333902	0333958
		1-5/8	4	0333311	-
3/8	3/8	1	2-1/2	0332229	0332324
		1-1/8	3	0333904	0333960
		1-1/2	6	0332401	0332442
		1-3/4	4	0333314	0333420
1/2	1/2	1	3	0332233	0332326
		1-1/2	6	0332406	0332443
		2	4	0333909	0333964
		3	6	0333321	-
5/8	5/8	1-1/4	3-1/2	0332236	-
		2-1/4	5	0333911	-
3/4	3/4	1-1/2	4	0332239	-
		2-1/4	5	0333912	-

Cutter Dia d1	Shank Dia d2	Length of Cut l2	Overall Length l1	Order Code SQ	Order Code BN
1	3	3	38	0332478	0332894
1.5	3	6	38	0334408	0334412
2	3	9	38	0334409	0334413
2.5	3	9,5	38	0332480	-
3	3	12	38	0332481	0332898
		19	57	0332052	0334468
		25	75	0332018	0332850
4	4	14	50	0332483	0332900
		19	63	0332053	0334469
		31	75	0332019	0332851
5	5	16	50	0332485	0332902
		19	63	0332054	0334470
		31	100	0332057	0334473
6	6	19	63	0332486	0332903
		29	75	0332020	0332852
		38	100	0332058	0334475
8	8	20	63	0332488	0332905
		29	75	0332021	0332853
		41	100	0332059	-
10	10	25	72	0332490	0332907
		40	88	0332056	0334518
		45	100	0332022	-
12	12	25	76	0332491	0332908
		50	100	0332023	0332855
		75	150	0332024	-



TOOL TIP

Tip for Small-Diameter End Mills.

When using small-diameter end mills, it is not uncommon to have less spindle speed on a machine than what is suggested in the speed and feed chart. When dealing with this condition, it is important to remember to maintain the suggested “load” on the tool – don’t decrease the chip load shown in the chart to equal the lower spindle speed.

- Run the maximum RPM that the machine will safely allow.
- Use the suggested chip load from the speed and feed chart.
- Maintain the suggested axial and radial tool engagements.

This combination will ensure the best tool life and proper finish.



E Series Application Guide – Speed & Feed (inch)

ISO Code	Work Material	Type of Cut	Axial DOC	Radial DOC	Number of Flutes	Speed (SFM)			Feed (Inches Per Tooth)									
						Uncoated	TiCN	AlTiN	1/16	1/8	3/16	1/4	5/16	3/8	1/2	5/8	3/4	1
K	Cast Iron - Gray	Slotting	.5 x D	1 x D	4	--	350	350	.00032	.0006	.0010	.0013	.0016	.0019	.0026	.0032	.0038	.0051
		Peripheral - Rough	1 x D	.5 x D	4	--	400	400	.00040	.0008	.0012	.0016	.0020	.0024	.0032	.0040	.0048	.0064
		Peripheral - Finish	1.5 x D	.01 x D	4	--	450	450	.00046	.0009	.0014	.0018	.0023	.0027	.0036	.0046	.0055	.0073
	Cast Iron - Ductile	Slotting	.5 x D	1 x D	4	--	250	250	.00030	.0006	.0009	.0012	.0015	.0018	.0024	.0030	.0036	.0048
		Peripheral - Rough	1 x D	.5 x D	4	--	275	275	.00038	.0008	.0011	.0015	.0019	.0023	.0030	.0038	.0045	.0060
		Peripheral - Finish	1.5 x D	.01 x D	4	--	325	325	.00042	.0008	.0013	.0017	.0021	.0025	.0034	.0042	.0051	.0068
P	Low Carbon Steels 1018, 12L14, 8620	Slotting	.5 x D	1 x D	4	250	275	300	.00030	.0006	.0009	.0012	.0015	.0018	.0024	.0030	.0036	.0048
		Slotting	.5 x D	1 x D	3	250	275	300	.00030	.0006	.0009	.0012	.0015	.0018	.0024	.0030	.0036	.0048
		Peripheral - Rough	1 x D	.5 x D	4	275	300	325	.00038	.0008	.0011	.0015	.0019	.0023	.0030	.0038	.0045	.0060
		Peripheral - Rough	1 x D	.5 x D	3	275	300	325	.00038	.0008	.0011	.0015	.0019	.0023	.0030	.0038	.0045	.0060
		Finish	1.5 x D	.01 x D	4	300	325	350	.00047	.0009	.0014	.0019	.0024	.0028	.0038	.0047	.0057	.0075
		Finish	1.5 x D	.01 x D	4	300	325	350	.00047	.0009	.0014	.0019	.0024	.0028	.0038	.0047	.0057	.0075
	Medium Carbon Steels 4140, 4340	Slotting	.5 x D	1 x D	4	225	250	275	.00027	.0005	.0008	.0011	.0014	.0016	.0022	.0027	.0032	.0043
		Peripheral - Rough	1 x D	.5 x D	4	250	275	300	.00034	.0007	.0010	.0014	.0017	.0020	.0027	.0034	.0041	.0054
		Finish	1.5 x D	.01 x D	4	275	300	325	.00042	.0008	.0013	.0017	.0021	.0025	.0034	.0042	.0051	.0068
		Slotting	.5 x D	1 x D	4	225	250	275	.00025	.0005	.0008	.0010	.0013	.0015	.0020	.0025	.0030	.0040
		Peripheral - Rough	1 x D	.5 x D	4	250	275	300	.00031	.0006	.0009	.0013	.0016	.0019	.0025	.0031	.0038	.0050
		Finish	1.5 x D	.01 x D	4	275	300	325	.00039	.0008	.0012	.0016	.0020	.0024	.0031	.0039	.0047	.0063
Tool & Die Steels ≤ 48 HRC A2, D2, H13, P20	Slotting	.5 x D	1 x D	4	225	250	275	.00025	.0005	.0008	.0010	.0013	.0015	.0020	.0025	.0030	.0040	
	Peripheral - Rough	1 x D	.5 x D	4	250	275	300	.00031	.0006	.0009	.0013	.0016	.0019	.0025	.0031	.0038	.0050	
	Finish	1.5 x D	.01 x D	4	275	300	325	.00039	.0008	.0012	.0016	.0020	.0024	.0031	.0039	.0047	.0063	
H	Hardened Steels 49 HRC to 58 HRC	Slotting	.25 x D	1 x D	4	60	75	225	.00014	.0003	.0004	.0006	.0007	.0008	.0011	.0014	.0017	.0022
		Peripheral - Rough	1 x D	.25 x D	4	80	100	250	.00017	.0003	.0005	.0007	.0009	.0010	.0014	.0017	.0021	.0028
		Finish	1.5 x D	.01 x D	4	100	125	275	.00019	.0004	.0006	.0008	.0009	.0011	.0015	.0019	.0023	.0030
M	Martensitic Stainless Steels 416, 410, 440C	Slotting	.5 x D	1 x D	4	--	250	250	.00020	.0004	.0006	.0008	.0010	.0012	.0016	.0020	.0024	.0032
		Peripheral - Rough	1 x D	.5 x D	4	--	275	275	.00025	.0005	.0008	.0010	.0013	.0015	.0020	.0025	.0030	.0040
		Finish	1.5 x D	.01 x D	4	--	325	325	.00031	.0006	.0009	.0013	.0016	.0019	.0025	.0031	.0038	.0050
	Austenitic Stainless Steels 303, 304, 316	Slotting	.5 x D	1 x D	4	200	225	250	.00020	.0004	.0006	.0008	.0010	.0012	.0016	.0020	.0024	.0032
		Slotting	.5 x D	1 x D	3	200	225	250	.00020	.0004	.0006	.0008	.0010	.0012	.0016	.0020	.0024	.0032
		Peripheral - Rough	1 x D	.5 x D	4	250	275	300	.00025	.0005	.0008	.0010	.0013	.0015	.0020	.0025	.0030	.0040
		Peripheral - Rough	1 x D	.5 x D	3	250	275	300	.00025	.0005	.0008	.0010	.0013	.0015	.0020	.0025	.0030	.0040
		Finish	1.5 x D	.01 x D	4	300	325	350	.00031	.0006	.0009	.0013	.0016	.0019	.0025	.0031	.0038	.0050
		Finish	1.5 x D	.01 x D	4	300	325	350	.00031	.0006	.0009	.0013	.0016	.0019	.0025	.0031	.0038	.0050
	Precipitation Hardening Stainless Steels 17-4 PH, 15-5 PH	Slotting	.25 x D	1 x D	4	175	200	225	.00020	.0004	.0006	.0008	.0010	.0012	.0016	.0020	.0024	.0031
		Peripheral - Rough	1 x D	.25 x D	4	200	225	250	.00025	.0005	.0007	.0010	.0012	.0015	.0020	.0025	.0029	.0039
		Finish	1.5 x D	.01 x D	4	225	250	275	.00027	.0005	.0008	.0011	.0013	.0016	.0021	.0027	.0032	.0043
S	Titanium Alloys	Slotting	.25 x D	1 x D	4	175	200	225	.00020	.0004	.0006	.0008	.0010	.0012	.0016	.0020	.0024	.0031
		Peripheral - Rough	1 x D	.25 x D	4	200	225	250	.00025	.0005	.0007	.0010	.0012	.0015	.0020	.0025	.0029	.0039
	High Temperature Alloys Inconel, Haynes, Stellite, Hastalloy	Finish	1.5 x D	.01 x D	4	225	250	275	.00027	.0005	.0008	.0011	.0013	.0016	.0021	.0027	.0032	.0043
		Slotting	.25 x D	1 x D	4	35	40	45	.00017	.0003	.0005	.0007	.0009	.0010	.0014	.0017	.0021	.0028
		Peripheral - Rough	1 x D	.25 x D	4	45	50	60	.00022	.0004	.0006	.0009	.0011	.0013	.0017	.0022	.0026	.0035
		Finish	1.5 x D	.01 x D	4	55	55	65	.00024	.0005	.0007	.0009	.0012	.0014	.0019	.0024	.0028	.0038
N	Aluminum Alloys 2024, 6061, 7075	Slotting	.5 x D	1 x D	2	350	550	--	.00038	.0008	.0011	.0015	.0019	.0023	.0030	.0038	.0046	.0061
		Peripheral - Rough	1 x D	.5 x D	2	450	650	--	.00048	.0010	.0014	.0019	.0024	.0029	.0038	.0048	.0057	.0076
		Peripheral - Finish	1.5 x D	.01 x D	3	550	--	--	.00053	.0011	.0016	.0021	.0027	.0032	.0043	.0053	.0064	.0085
	Copper Alloys Brass & Bronze	Slotting	.5 x D	1 x D	2	275	350	350	.00040	.0008	.0012	.0016	.0020	.0024	.0032	.0040	.0048	.0064
		Peripheral - Rough	1 x D	.5 x D	2	300	400	400	.00050	.0010	.0015	.0020	.0025	.0030	.0040	.0050	.0060	.0080
		Peripheral - Rough	1 x D	.5 x D	3	300	--	400	.00045	.0009	.0014	.0018	.0023	.0027	.0036	.0045	.0054	.0072
		Peripheral - Finish	1.5 x D	.01 x D	2	350	450	450	.00063	.0013	.0019	.0025	.0031	.0038	.0050	.0063	.0075	.0101
		Peripheral - Finish	1.5 x D	.01 x D	3	350	--	450	.00057	.0011	.0017	.0023	.0028	.0034	.0045	.0057	.0068	.0090
		Peripheral - Finish	1.5 x D	.01 x D	3	350	--	450	.00057	.0011	.0017	.0023	.0028	.0034	.0045	.0057	.0068	.0090
	Composites, Plastics	Slotting	.5 x D	1 x D	4	300	350	350	.00040	.0008	.0012	.0016	.0020	.0024	.0032	.0040	.0048	.0064
		Peripheral - Rough	1 x D	.5 x D	4	375	450	450	.00050	.0010	.0015	.0020	.0025	.0030	.0040	.0050	.0060	.0080
		Peripheral - Finish	1.5 x D	.01 x D	4	450	650	650	.00057	.0011	.0017	.0023	.0028	.0034	.0045	.0057	.0068	.0090
	Magnesium Alloys	Slotting	.5 x D	1 x D	2	350	550	550	.00040	.0008	.0012	.0016	.0020	.0024	.0032	.0040	.0048	.0064
		Peripheral - Rough	1 x D	.5 x D	2	450	650	650	.00050	.0010	.0015	.0020	.0025	.0030	.0040	.0050	.0060	.0080
		Peripheral - Finish	1.5 x D	.01 x D	2	550	750	750	.00057	.0011	.0017	.0023	.0028	.0034	.0045	.0057	.0068	.0090
	Graphite	Slotting	.5 x D	1 x D	4	350	400	450	.00045	.0009	.0014	.0018	.0023	.0027	.0036	.0045	.0054	.0072
		Peripheral - Rough	1 x D	.5 x D	4	425	475	525	.00056	.0011	.0017	.0023	.0028	.0034	.0045	.0056	.0068	.0090
		Peripheral - Finish	1.5 x D	.01 x D	4	500	550	600	.00063	.0013	.0019	.0025	.0031	.0038	.0050	.0063	.0075	.0101

D = Tool Diameter

Information on tips and adjustments can be found in our Technical Resources section beginning on page 134.

E Series Application Guide – Speed & Feed (metric)

ISO Code	Work Material	Type of Cut	Axial DOC	Radial DOC	Number of Flutes	Speed (M/min)			Feed (MM per Tooth)									
						Uncoated	TiCN	AlTiN	3.0	4.0	5.0	6.0	8.0	10.0	12.0	14.0	16.0	20.0
K	Cast Iron - Gray	Slotting	.5 x D	1 x D	4	--	107	107	.0154	.0205	.0256	.0307	.0410	.0512	.0614	.0717	.0768	.1026
		Peripheral - Rough	1 x D	.5 x D	4	--	122	122	.0192	.0256	.0320	.0384	.0512	.0640	.0768	.0896	.0960	.1282
		Peripheral - Finish	1.5 x D	.01 x D	4	--	137	137	.0219	.0291	.0364	.0437	.0583	.0729	.0874	.1020	.1093	.1460
	Cast Iron - Ductile	Slotting	.5 x D	1 x D	4	--	76	76	.0144	.0192	.0240	.0288	.0384	.0480	.0576	.0672	.0720	.0962
		Peripheral - Rough	1 x D	.5 x D	4	--	84	84	.0180	.0240	.0300	.0360	.0480	.0600	.0720	.0840	.0900	.1202
		Peripheral - Finish	1.5 x D	.01 x D	4	--	99	99	.0204	.0271	.0339	.0407	.0543	.0678	.0814	.0950	.1018	.1359
P	Low Carbon Steels 1018, 12L14, 8620	Slotting	.5 x D	1 x D	4	76	84	91	.0144	.0192	.0240	.0288	.0384	.0480	.0576	.0672	.0720	.0962
		Slotting	.5 x D	1 x D	3	76	84	91	.0144	.0192	.0240	.0288	.0384	.0480	.0576	.0672	.0720	.0962
		Peripheral - Rough	1 x D	.5 x D	4	84	91	99	.0180	.0240	.0300	.0360	.0480	.0600	.0720	.0840	.0900	.1202
		Peripheral - Rough	1 x D	.5 x D	3	84	91	99	.0180	.0240	.0300	.0360	.0480	.0600	.0720	.0840	.0900	.1202
		Finish	1.5 x D	.01 x D	4	91	99	107	.0226	.0301	.0377	.0452	.0603	.0754	.0904	.1055	.1131	.1510
	Medium Carbon Steels 4140, 4340	Slotting	.5 x D	1 x D	4	69	76	84	.0130	.0173	.0216	.0259	.0346	.0432	.0518	.0605	.0648	.0866
		Peripheral - Rough	1 x D	.5 x D	4	76	84	91	.0162	.0216	.0270	.0324	.0432	.0540	.0648	.0756	.0810	.1082
		Finish	1.5 x D	.01 x D	4	84	91	99	.0204	.0271	.0339	.0407	.0543	.0678	.0814	.0950	.1018	.1359
	Tool & Die Steels ≤ 48 HRC A2, D2, H13, P20	Slotting	.5 x D	1 x D	4	69	76	84	.0120	.0160	.0200	.0240	.0320	.0400	.0480	.0560	.0600	.0802
		Peripheral - Rough	1 x D	.5 x D	4	76	84	91	.0150	.0200	.0250	.0300	.0400	.0500	.0600	.0700	.0750	.1002
		Finish	1.5 x D	.01 x D	4	84	91	99	.0188	.0251	.0314	.0377	.0503	.0628	.0754	.0879	.0942	.1259
	H	Hardened Steels 49 HRC to 58 HRC	Slotting	.25 x D	1 x D	4	18	23	69	.0067	.0089	.0111	.0133	.0177	.0222	.0266	.0310	.0333
Peripheral - Rough			1 x D	.25 x D	4	24	30	76	.0083	.0111	.0139	.0166	.0222	.0277	.0333	.0388	.0416	.0555
Finish			1.5 x D	.01 x D	4	30	38	84	.0090	.0121	.0151	.0181	.0241	.0301	.0362	.0422	.0452	.0604
M	Martensitic Stainless Steels 416, 410, 440C	Slotting	.5 x D	1 x D	4	--	76	76	.0096	.0128	.0160	.0192	.0256	.0320	.0384	.0448	.0480	.0641
		Peripheral - Rough	1 x D	.5 x D	4	--	84	84	.0120	.0160	.0200	.0240	.0320	.0400	.0480	.0560	.0600	.0802
		Finish	1.5 x D	.01 x D	4	--	99	99	.0151	.0201	.0251	.0301	.0402	.0502	.0603	.0703	.0754	.1007
	Austenitic Stainless Steels 303, 304, 316	Slotting	.5 x D	1 x D	4	61	69	76	.0096	.0128	.0160	.0192	.0256	.0320	.0384	.0448	.0480	.0641
		Slotting	.5 x D	1 x D	3	61	69	76	.0096	.0128	.0160	.0192	.0256	.0320	.0384	.0448	.0480	.0641
		Peripheral - Rough	1 x D	.5 x D	4	76	84	91	.0120	.0160	.0200	.0240	.0320	.0400	.0480	.0560	.0600	.0802
		Peripheral - Rough	1 x D	.5 x D	3	76	84	91	.0120	.0160	.0200	.0240	.0320	.0400	.0480	.0560	.0600	.0802
	Precipitation Hardening Stainless Steels 17-4 PH, 15-5 PH	Finish	1.5 x D	.01 x D	4	91	99	107	.0151	.0201	.0251	.0301	.0402	.0502	.0603	.0703	.0754	.1007
		Slotting	.25 x D	1 x D	4	53	61	69	.0094	.0126	.0157	.0188	.0251	.0314	.0377	.0440	.0471	.0629
Peripheral - Rough	1 x D	.25 x D	4	61	69	76	.0118	.0157	.0196	.0236	.0314	.0393	.0471	.0550	.0589	.0787		
	Finish	1.5 x D	.01 x D	4	69	76	84	.0128	.0171	.0214	.0256	.0342	.0427	.0513	.0598	.0641	.0856	
S	Titanium Alloys	Slotting	.25 x D	1 x D	4	53	61	69	.0094	.0126	.0157	.0188	.0251	.0314	.0377	.0440	.0471	.0629
		Peripheral - Rough	1 x D	.25 x D	4	61	69	76	.0118	.0157	.0196	.0236	.0314	.0393	.0471	.0550	.0589	.0787
		Finish	1.5 x D	.01 x D	4	69	76	84	.0128	.0171	.0214	.0256	.0342	.0427	.0513	.0598	.0641	.0856
	High Temperature Alloys Inconel, Haynes, Stellite, Hastalloy	Slotting	.25 x D	1 x D	4	11	12	14	.0083	.0111	.0139	.0166	.0222	.0277	.0333	.0388	.0416	.0555
		Peripheral - Rough	1 x D	.25 x D	4	14	15	18	.0104	.0139	.0173	.0208	.0277	.0346	.0416	.0485	.0520	.0694
		Finish	1.5 x D	.01 x D	4	17	17	20	.0113	.0151	.0188	.0226	.0302	.0377	.0452	.0528	.0565	.0755
N	Aluminum Alloys 2024, 6061, 7075	Slotting	.5 x D	1 x D	2	107	168	--	.0182	.0243	.0304	.0365	.0486	.0608	.0730	.0851	.0912	.1218
		Peripheral - Rough	1 x D	.5 x D	2	137	198	--	.0228	.0304	.0380	.0456	.0608	.0760	.0912	.1064	.1140	.1523
		Peripheral - Finish	1.5 x D	.01 x D	3	168	--	--	.0256	.0342	.0427	.0513	.0683	.0854	.1025	.1196	.1281	.1712
	Copper Alloys Brass & Bronze	Slotting	.5 x D	1 x D	2	84	107	107	.0192	.0256	.0320	.0384	.0512	.0640	.0768	.0896	.0960	.1282
		Peripheral - Rough	1 x D	.5 x D	2	91	122	122	.0240	.0320	.0400	.0480	.0640	.0800	.0960	.1120	.1200	.1603
		Peripheral - Rough	1 x D	.5 x D	3	91	--	122	.0216	.0288	.0360	.0432	.0576	.0720	.0864	.1008	.1080	.1443
		Peripheral - Finish	1.5 x D	.01 x D	2	107	137	137	.0301	.0402	.0502	.0603	.0804	.1005	.1206	.1407	.1507	.2014
		Peripheral - Finish	1.5 x D	.01 x D	3	107	--	137	.0271	.0362	.0452	.0543	.0724	.0904	.1085	.1266	.1357	.1813
	Composites, Plastics	Slotting	.5 x D	1 x D	4	91	107	107	.0192	.0256	.0320	.0384	.0512	.0640	.0768	.0896	.0960	.1282
		Peripheral - Rough	1 x D	.5 x D	4	114	137	137	.0240	.0320	.0400	.0480	.0640	.0800	.0960	.1120	.1200	.1603
		Peripheral - Finish	1.5 x D	.01 x D	4	137	198	198	.0271	.0362	.0452	.0543	.0724	.0904	.1085	.1266	.1357	.1813
	Magnesium Alloys	Slotting	.5 x D	1 x D	2	107	168	168	.0192	.0256	.0320	.0384	.0512	.0640	.0768	.0896	.0960	.1282
		Peripheral - Rough	1 x D	.5 x D	2	137	198	198	.0240	.0320	.0400	.0480	.0640	.0800	.0960	.1120	.1200	.1603
	Peripheral - Finish	1.5 x D	.01 x D	2	168	229	229	.0271	.0362	.0452	.0543	.0724	.0904	.1085	.1266	.1357	.1813	
	Graphite	Slotting	.5 x D	1 x D	4	107	122	137	.0216	.0288	.0360	.0432	.0576	.0720	.0864	.1008	.1080	.1443
		Peripheral - Rough	1 x D	.5 x D	4	130	145	160	.0270	.0360	.0450	.0540	.0720	.0900	.1080	.1260	.1350	.1803
		Peripheral - Finish	1.5 x D	.01 x D	4	152	168	183	.0301	.0402	.0502	.0603	.0804	.1005	.1206	.1407	.1507	.2014

D = Tool Diameter

Information on tips and adjustments can be found in our Technical Resources section beginning on page 134.

M104 truCORE

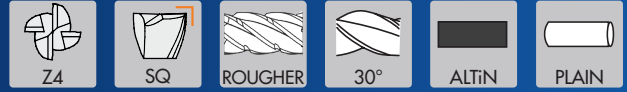

For machining low carbon and tool steels under 40 HRC. The M104 Rougher/Finisher has a unique chipbreaker geometry that allows for high feed rates, excellent chip control and finishes superior to most 4-flute roughing end mills. The ALTiN coating offers superior heat resistance and hardness for increased tool life.

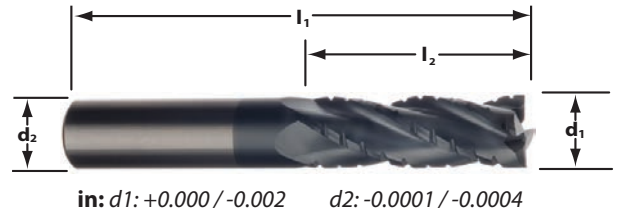

Cutter Dia d1	Shank Dia d2	Length of Cut l2	Overall Length l1	Order Code SQ
1/8	1/8	1/4	1-1/2	0333158
		1/2	1-1/2	0332113
3/16	3/16	3/8	2	0333161
		5/8	2	0332119
1/4	1/4	1/2	2	0338041
		3/4	2-1/2	0338082
5/16	5/16	1-1/8	3	0333163
		1/2	2	0333136
3/8	3/8	13/16	2-1/2	0332173
		5/8	2	0333093
1/2	1/2	1	2-1/2	0333127
		1-1/8	3	0333164
5/8	5/8	5/8	2-1/2	0333146
		1	3	0338080
3/4	3/4	2	4	0332115
		1-1/4	3-1/2	0333131
1	1	2-1/4	5	0338054
		1	3	0333162
		1-1/2	4	0333133
		2-1/4	5	0333165
		1-1/2	4	0333135
		2-1/4	5	0333166

M104 Application Guide – Speed & Feed (inch)

ISO Code	Work Material	Type of Cut	Axial DOC	Radial DOC	Number of Flutes	Speed (SFM)	Feed (Inch per Tooth)								
							1/8	3/16	1/4	5/16	3/8	1/2	5/8	3/4	1
P	Low Carbon Steels 1018, 12L14, 8620	Slotting	1 x D	1 x D	4	350	.0015	.0009	.0012	.0015	.0018	.0024	.0030	.0036	.0048
		Peripheral-Rough	≤ 2 x D	.4 x D	4	425	.0008	.0011	.0015	.0019	.0023	.0030	.0038	.0045	.0060
		Peripheral-Rough	> 2 - 3 x D	.4 x D	4	400	.0007	.0011	.0014	.0018	.0021	.0028	.0035	.0042	.0056
		Peripheral-Rough	> 3 - 4 x D	.35 x D	4	385	.0007	.0010	.0013	.0016	.0020	.0026	.0033	.0039	.0052
		*Helical Ramp Angle	1 - 2 deg.	1 x D	4	350	.0005	.0007	.0010	.0012	.0014	.0019	.0024	.0029	.0038
	Medium Carbon Steels <38 HRC 4140, 4340	Slotting	.75 x D	1 x D	4	275	.0011	.0009	.0012	.0014	.0017	.0023	.0029	.0035	.0046
		Peripheral-Rough	≤ 2 x D	.4 x D	4	350	.0007	.0011	.0015	.0018	.0022	.0029	.0036	.0044	.0058
		Peripheral-Rough	> 2 - 3 x D	.4 x D	4	335	.0007	.0010	.0014	.0017	.0020	.0027	.0034	.0041	.0054
		Peripheral-Rough	> 3 - 4 x D	.35 x D	4	315	.0006	.0009	.0013	.0016	.0019	.0025	.0031	.0038	.0050
		*Helical Ramp Angle	1 - 2 deg.	1 x D	4	275	.0005	.0007	.0009	.0012	.0014	.0018	.0023	.0028	.0037
	Tool & Die Steels < 38 HRC A2, D2, H13, P20	Slotting	1 x D	1 x D	4	275	.0006	.0009	.0012	.0015	.0018	.0024	.0030	.0036	.0048
		Peripheral-Rough	≤ 2 x D	.3 x D	4	350	.0007	.0011	.0015	.0018	.0022	.0029	.0036	.0044	.0058
Peripheral-Rough		> 2 - 3 x D	.3 x D	4	335	.0007	.0010	.0014	.0017	.0020	.0027	.0034	.0041	.0054	
Peripheral-Rough		> 3 - 4 x D	.25 x D	4	315	.0006	.0009	.0013	.0016	.0019	.0025	.0031	.0038	.0050	
	*Helical Ramp Angle	1 - 2 deg.	1 x D	4	275	.0005	.0007	.0010	.0012	.0014	.0019	.0024	.0029	.0038	
M	Martensitic Stainless Steels 416, 410, 440C	Slotting	.75 x D	1 x D	4	250	.0005	.0008	.0011	.0013	.0016	.0021	.0026	.0032	.0042
		Peripheral-Rough	≤ 2 x D	.3 x D	4	300	.0007	.0010	.0013	.0016	.0020	.0026	.0033	.0039	.0052
		Peripheral-Rough	> 2 - 3 x D	.3 x D	4	285	.0006	.0009	.0013	.0016	.0019	.0025	.0031	.0038	.0050
		Peripheral-Rough	> 3 - 4 x D	.25 x D	4	270	.0006	.0009	.0012	.0014	.0017	.0023	.0029	.0035	.0046
	*Helical Ramp Angle	1 - 2 deg.	1 x D	4	250	.0004	.0006	.0008	.0011	.0013	.0017	.0021	.0025	.0034	

≈ Approximately Equals × Multiply
 ≤ Less Than or Equal To < Less Than
 ≥ Greater Than or Equal To = Equals

E520B truCORE

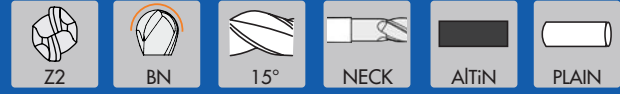

For contouring in carbon and tool steels. The E520B is designed for contouring applications in pre-hard and hardened steels. Added length and necked shank provide for stability when machining in deeper cavities. The AlTiN coating offers superior heat resistance and hardness for increased tool life.

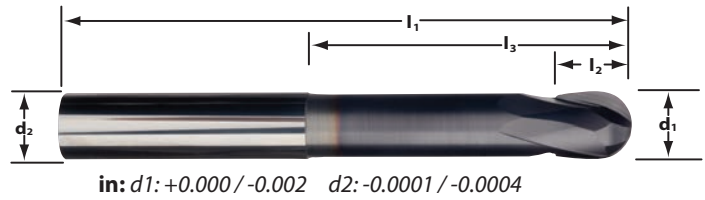

Cutter Dia d1	Shank Dia d2	Length of Cut I2	Reach LBS I3	Overall Length I1	Order Code BN
1/8	1/4	1/8	3/8	3	0333447
3/16	1/4	3/16	9/16	3	0333448
1/4	1/4	1/4	1-5/8	3	0333449
3/8	3/8	3/8	2-1/4	4	0333451
1/2	1/2	1/2	2-1/4	4	0333452

E520B Application Guide – Speed & Feed (inch)

ISO Code	Work Material Hardness	Type of Cut	Axial DOC	Radial DOC	No. of Flutes	Speed (SFM)	Feed (Inches per Tooth)			
							1/8	1/4	3/8	1/2
P	≤ 48 HRC	Rough	.2 x D	.2 x D	2	400	.0013	.0025	.0038	.0050
		Finish	.02 x D	.02 x D	2	275	.0015	.0030	.0045	.0060
H	49 to 57 HRC	Rough	.2 x D	.2 x D	2	375	.0008	.0017	.0025	.0033
		Finish	.02 x D	.02 x D	2	250	.0010	.0020	.0030	.0040
	58 to 62 HRC	Rough	.1 x D	.1 x D	2	250	.0007	.0014	.0021	.0028
		Finish	.01 x D	.01 x D	2	150	.0005	.0011	.0016	.0021

≈ Approximately Equals
 ≤ Less Than or Equal To
 ≥ Greater Than or Equal To
 × Multiply
 < Less Than
 > Greater Than
 = Equals

Common Machining Formulas

$$RPM = \frac{SFM \times 3.82}{D}$$

$$SFM = RPM \times D \times .262$$

$$IPM = RPM \times IPT \times Z$$

$$MRR = RDOC \times ADOC \times IPM$$

- D** Tool Cutting Diameter
- Z** Number of Flutes
- RPM** Revolutions per Minute
- SFM** Surface Feet per Minute
- IPM** Inches per Minute
- MRR** Metal Removal Rate
- RDOC** Radial Depth of Cut
- ADOC** Axial Depth of Cut

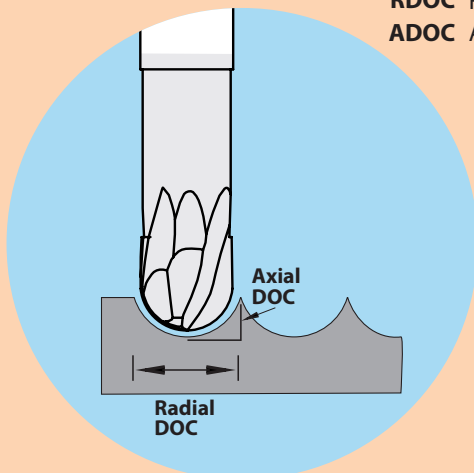

Technical Resources

Information on tips and adjustments for the following milling operations can be found in our Technical Resources section beginning on page 134.

- HEM slotting
- Face milling
- Helical entry ramping
- Straight line ramping
- Long tool projection adjustments
- Ball nose milling adjustments
- Other helpful tips and calculations

TECH SUPPORT

Use the guidelines shown in this section when machining a variety of tool paths. When necessary, adjustments refer back to the specific end mill speed and feed charts as listed throughout the catalog and can be found on the following pages:

IPT/C7: PG. 20	M806: PG. 73
IPT/C9: PG. 26	M924: PG. 82
IPT/C11: PG. 30	M904: PG. 85
IPT/C13: PG. 34	M905: PG. 86
APT/C5: PG. 40	M213: PG. 93
AFC5/IFC5: PG. 43	M223: PG. 100
M525: PG. 50	M233: PG. 104
M527: PG. 54	M202/203: PG. 110
M503: PG. 56	E series: PG. 130
M726: PG. 66	M104: PG. 132
M706: PG. 67	E520B: PG. 133



Technical Resources

HEM SLOTTING GUIDES

The width of the desired slot will determine the number of flutes and end mill diameter that should be selected. The following guide shows the minimum slot width for each series of end mill.

Tool	Minimum Slot Width	Maximum Slot Depth
IPT/C 7	2 x end mill diameter	Full length of cut
IPT/C 9	2 x end mill diameter	Full length of cut
IPT/C 11	2.25 x end mill diameter	Full length of cut
IPT/C 13	2.5 x end mill diameter	Full length of cut
APT/C 5	1.75 x end mill diameter	Full length of cut
M525/C	1.75 x end mill diameter	.8 x length of cut
M527/C	2 x end mill diameter	.8 x length of cut

Speed and feed parameters for HEM slotting can be found marked as "Peripheral-HEM" for POW•R•PATH and as "HEM" for enDURO tools in the speed and feed charts for those series.

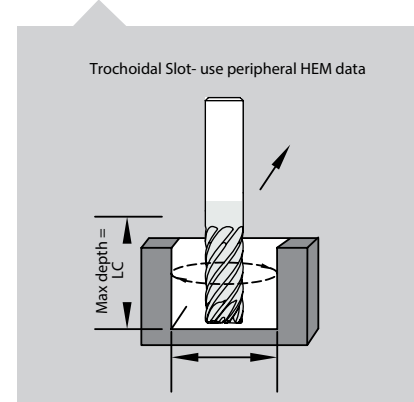

FACING

When facing, an end mill with a corner radius is suggested for the best finish. Apply the adjustments below to the Peripheral Rough values from the application guide for the end mill being used.

RDOC Formula

$$\text{Step-over} = (D - (2 \times \text{corner radius})) \times .75$$

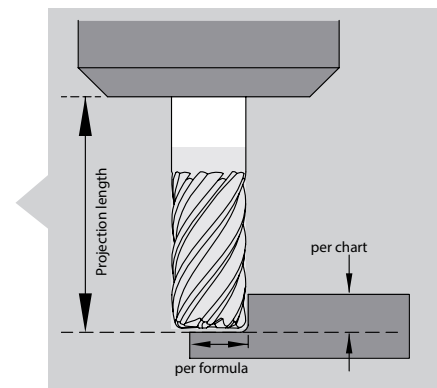

Non-IP End Mills

Projection Length	Rough Facing			Finish Facing		
	SFM or M/min	IPT or mm/tooth	ADOC	SFM or M/min	IPT or mm/tooth	ADOC
0 to 3 x D	1.2 x chart value	.85 x chart value	.25 x D Maximum	1.2 x chart value	.75 x chart value	.07 x D Maximum
> 3 to 4 x D	1.1 x chart value	.75 x chart value	.25 x D Maximum	1.1 x chart value	.65 x chart value	.07 x D Maximum
> 4 to 5 x D	1.0 x chart value	.65 x chart value	.25 x D Maximum	1.0 x chart value	.55 x chart value	.06 x D Maximum
> 5 to 6 x D	.9 x chart value	.55 x chart value	.25 x D Maximum	.9 x chart value	.45 x chart value	.05 x D Maximum

IP End Mills

Projection Length	Rough Facing			Finish Facing		
	SFM or M/min	IPT or mm/tooth	ADOC	SFM or M/min	IPT or mm/tooth	ADOC
0 to 3 x D	1.0 x chart value	.40 x chart value	.25 x D Maximum	1.0 x chart value	.70 x chart value	.07 x D Maximum
> 3 to 4 x D	1.0 x chart value	.40 x chart value	.25 x D Maximum	1.0 x chart value	.70 x chart value	.07 x D Maximum
> 4 to 5 x D	1.0 x chart value	.40 x chart value	.20 x D Maximum	1.0 x chart value	.70 x chart value	.05 x D Maximum
> 5 to 6 x D	1.0 x chart value	.40 x chart value	.20 x D Maximum	1.0 x chart value	.70 x chart value	.05 x D Maximum

D = Tool Diameter

Technical Resources

HELICAL RAMP TO CREATE AN ENTRY HOLE

Using a helical ramp move to generate an entry hole is a preferred method to enter the middle of a part. The creation of the entry hole can be either a one-step or a two-step process depending on the number of flutes on the end mill. Tools with seven or fewer flutes only require one step; tools with more than seven flutes require two steps.

Step 1: Create helical ramp entry hole

The diameter of the starting hole will be: $(\text{tool diameter} \times 2) - (\text{corner radius} \times 2)$

Use the following guide for speed, feed and ramp angle parameters. Note that the terms "Same as chart," "Slotting speed in chart," "Slotting feed in chart," and IPT and MMPT reference the data that is shown in the speed and feed charts located in each tool series section.

Tool	Speed	Feed Adjustment – with high-pressure coolant	Feed Adjustment – with standard flood coolant	Ramp Angle
IPT/C 7	Same as chart	IPT or MMPT x 1.6	IPT or MMPT x 1.25	0.5°
IPT/C 9	Same as chart	IPT or MMPT x 1.6	IPT or MMPT x 1.25	0.5°
IPT/C 11	Same as chart	IPT or MMPT x 1.6	IPT or MMPT x 1.25	0.5°
IPT/C 13	Same as chart	IPT or MMPT x 1.6	IPT or MMPT x 1.25	0.5°
APT/C 5	Same as chart	IPT or MMPT x 1.6	IPT or MMPT x 1.25	3°
M525	Slotting speed in chart	Slotting feed in chart	Slotting feed in chart	1° - 2.5°
M527	Slotting speed in chart	Slotting feed in chart	Slotting feed in chart	1° - 2.5°
M503	Slotting speed in chart	Slotting feed in chart	Slotting feed in chart	1° - 2.5°
M726	Slotting speed in chart	Slotting feed in chart	Slotting feed in chart	1° - 2.5°
M706	Slotting speed in chart	Slotting feed in chart	Slotting feed in chart	1° - 2.5°
M806	Slotting speed in chart	Slotting feed in chart	Slotting feed in chart	1° - 2.5°
M924	Slotting speed in chart	Slotting feed in chart	Slotting feed in chart	1° - 2.5°
M904	Slotting speed in chart	Slotting feed in chart	Slotting feed in chart	1° - 2.5°
M905	Slotting speed in chart	Slotting feed in chart	Slotting feed in chart	1° - 2.5°
M223	Slotting speed in chart	Slotting feed in chart	Slotting feed in chart	3° - 5°
M233	Slotting speed in chart	Slotting feed in chart	Slotting feed in chart	3° - 5°
M203	Slotting speed in chart	Slotting feed in chart	Slotting feed in chart	3° - 5°
M202	Slotting speed in chart	Slotting feed in chart	Slotting feed in chart	3° - 5°
E14	Slotting speed in chart	Slotting feed in chart	Slotting feed in chart	1° - 2.5°
E13	Slotting speed in chart	Slotting feed in chart	Slotting feed in chart	1° - 2.5°
E12	Slotting speed in chart	Slotting feed in chart	Slotting feed in chart	1° - 2.5°
M104	Slotting speed in chart	Slotting feed in chart	Slotting feed in chart	1° - 2.5°

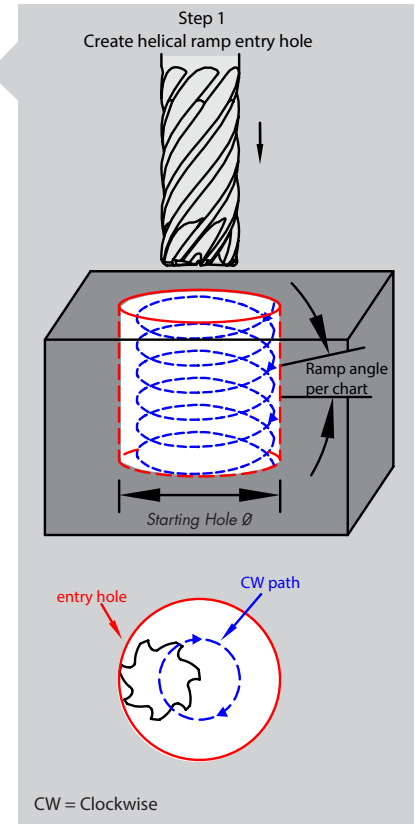

IPT = Inch per tooth from the speed and feed charts

MMPT = Millimeter per tooth from the speed and feed charts

Speed = Surface feet per minute (SFM) or meters per min (M/Min)

Step 2: There are two common methods to open up the starter hole.

METHOD A – Expand the entry hole from inside out.

7-, 9-, 11- and 13-flute tools

After reaching the desired entry hole depth in Step 1, and with the end mill still at depth, expand the hole outwards using the feed rate adjustment found in the chart below. Continue until the entry hole is enlarged to the expanded diameter shown below.

Tool	Expanded Hole Ø	Feed Rate Adjustment	Step-Over Adjustment
IPT/C 7,9	3 x D	IPT or MMPT x .75	RDOC x .5
IPT/C 11	3.75 x D	IPT or MMPT x .75	RDOC x .5
IPT/C 13	3.75 x D	IPT or MMPT x .75	RDOC x .5

D = Tool Diameter

Once the expanded entry hole diameter is achieved, climb cut machining can begin at 100% of the Peripheral-HEM values in the feed and speed chart for the tool series you're using.

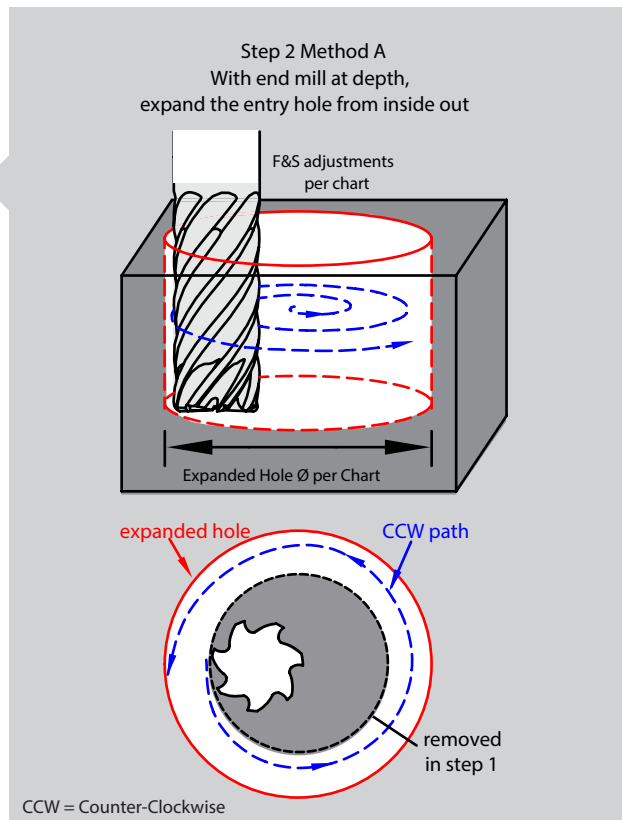

METHOD B – Expand the entry hole with a second helical ramp move.

Method B will expand the entry hole by doing a second helical ramp entry hole of a larger diameter than in Step 1. After completing Step 1, retract the end from the hole, and machine the second helical ramp entry hole using the same speed, feed and location as the first hole.

Tool	Expanded Hole Ø	Feed Rate Adjustment	Ramp Angle
IPT/C 9	3 x D	IPT or MMPT x 1.6	0.5°
IPT/C 11	3.75 x D	IPT or MMPT x 1.6	0.5°
IPT/C 13	3.75 x D	IPT or MMPT x 1.6	0.5°

D = Tool Diameter

Once the expanded entry hole diameter is achieved, climb cut machining can begin at 100% of the Peripheral-HEM values in the feed and speed chart for the tool series you're using.

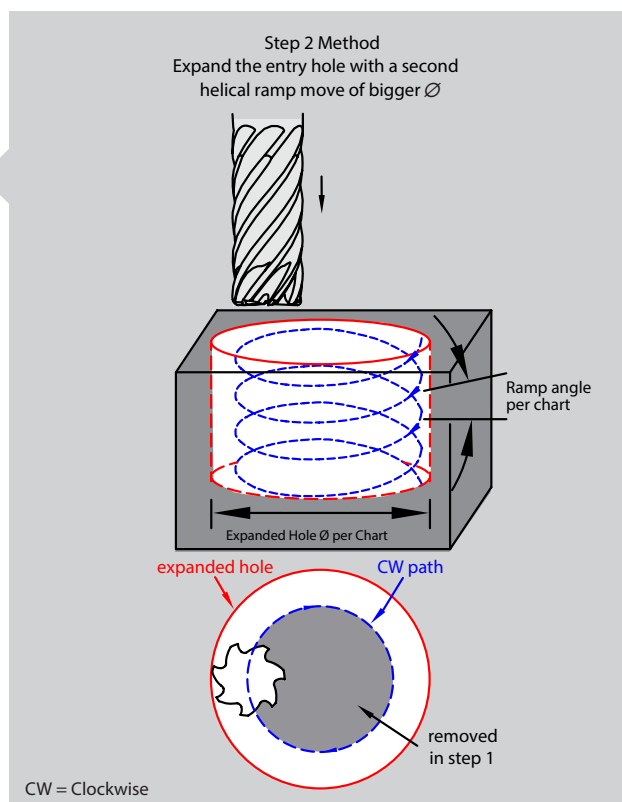

Technical Resources

STRAIGHT-LINE RAMP ADJUSTMENTS

Straight-line ramp moves are an alternative method to enter the middle of a part. The following guide shows speed, feed and ramp angle data for different IMCO end mills.

Use the following guide for speed, feed and ramp angle parameters. Note that the terms "Same as chart," "Slotting speed in chart," and "Slotting IPT/MMPT," and "Helical ramp" (M223 and M233) reference the data shown in the speed and feed charts located in each tool series section. Not all tools are designed to allow the chip clearance required for straight-line ramping, as indicated in the guide.

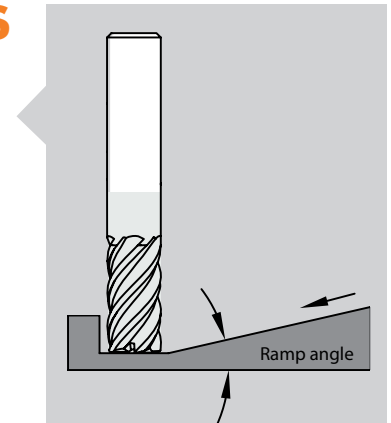

Tool	Max Ramp Angle	SFM / MMPM	Feed	Max Ramp Depth	Max Ramp Length
IPT/C 7	Not recommended	-	-	-	-
IPT/C 9	Not recommended	-	-	-	-
IPT/C 11	Not recommended	-	-	-	-
IPT/C 13	Not recommended	-	-	-	-
APT/C 5	10°	Slotting speed	Slotting IPT or MMPT x .65	75% of D	(.75 x D) / drop per inch or mm
M525	2.5°	Slotting speed	Slotting IPT or MMPT x .75	50% of D	(.5 x D) / drop per inch or mm
M527	2.5°	Slotting speed	Slotting IPT or MMPT x .75	50% of D	(.5 x D) / drop per inch or mm
M503	2.5°	Slotting speed	Slotting IPT x .75	50% of D	(.5 x D) / drop per inch
M726	Not recommended	-	-	-	-
M706	Not recommended	-	-	-	-
M806	Not recommended	-	-	-	-
M924	2.5°	Slotting speed	Slotting IPT or MMPT x .75	50% of D	(.5 x D) / drop per inch or mm
M904	2.5°	Slotting speed	Slotting IPT x .75	50% of D	(.5 x D) / drop per inch
M905	2.5°	Slotting speed	Slotting IPT x .75	50% of D	(.5 x D) / drop per inch
M223	Helical ramp x 5	Same as chart	Same as chart	100% of D	(.75 x D) / drop per inch or mm
M233	Helical ramp x 5	Same as chart	Same as chart	100% of D	(.75 x D) / drop per inch or mm
M203	15°	Slotting speed	Slotting IPT or MMPT x .70	50% of D	(.5 x D) / drop per inch or mm
M202	15°	Slotting speed	Slotting IPT or MMPT x .70	50% of D	(.5 x D) / drop per inch or mm
E14	2.5°	Slotting speed	Slotting IPT or MMPT x .75	50% of D	(.5 x D) / drop per inch or mm
E13	2.5°	Slotting speed	Slotting IPT or MMPT x .75	50% of D	(.5 x D) / drop per inch or mm
E12	2.5°	Slotting speed	Slotting IPT or MMPT x .75	50% of D	(.5 x D) / drop per inch or mm
M104	2.5°	Slotting speed	Slotting IPT x .75	50% of D	(.5 x D) / drop per inch

D = Tool Diameter

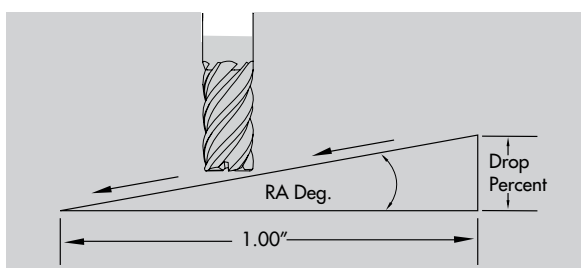

Use this guide to determine the maximum ramp length.

Ramp Angle	Drop (per inch)	Drop (per mm)
0.5°	0.0088	0.224
1°	0.0175	0.445
2°	0.0375	0.953
2.5°	0.0438	1.113
3°	0.0525	1.334
5°	0.0875	2.223
10°	0.1750	4.445
15°	0.2625	6.668

ADJUSTMENTS FOR LONG REACH APPLICATIONS

Using long-length tools increases the amount of tool projection from the tool holder and the spindle. As the tool projection increases so does the amount of tool deflection. Tool deflection causes chatter, resulting in poor surface finish and reduced tool life. Tool options that help minimize tool deflection in long projection applications are:

- Use a larger diameter tool for the operation. Larger tools have larger cores, which reduces deflection.
- Use a tool with a necked shank, which shortens the flute length and increases the core strength of the end mill.

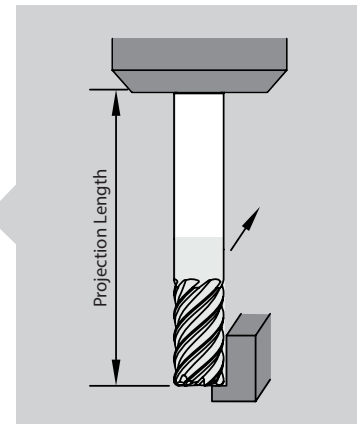

Speed and feed adjustments for long tool projections:

Adjustments must be made to reduce chatter and maximize tool life when using long length tools. The adjustments below are based on the total amount of tool projection and use the speed and feed data found in the application charts for each tool series.

Projection	SFM / MMPM	Feed
> 1.25 to 3 x D	SFM or M/min x .95	IPT or MMPT x .95
> 3 to 4 x D	SFM or M/min x .90	IPT or MMPT x .90
> 4 to 5 x D	SFM or MMPM x .80	IPT or MMPT x .80
> 5 to 6 x D	SFM or MMPM x .70	IPT or MMPT x .70

D = Tool diameter
 IPT = Inch per tooth
 MMPT = Millimeter per tooth
 SFM = Surface feet per minute
 MPM = Millimeters per minute

IMPORTANT NOTES: No adjustments are necessary when using the speed and feed data for HEM tool paths found in the charts for any of the POW•R•PATH and enDURO end mills. Use the data directly from the charts. This applies only when using HEM tool paths.

The M223 and M233 have the long projections adjustments already incorporated into the speed and feed charts for those series. Use the data directly from the charts with no adjustments for long projections.

Tool Tip: Eliminate Wall Taper When Finishing.

STEP 1:

Run a climb cut finish pass using speed, feed and step-over values (RDOC) from the speed and feed charts. Adjust for tool projection if needed.

STEP 2:

Re-run the path using the same speeds and feeds but in a conventional cut direction. Simply retrace the prior finish pass; do not program to remove more stock. This skim pass, traveling in the opposite direction of the first pass, will help eliminate wall taper caused by tool deflection during the first pass.

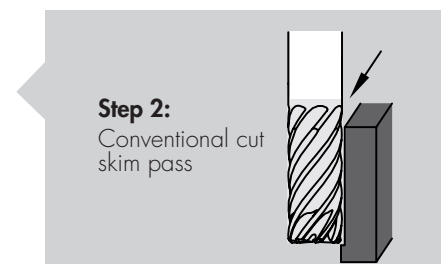
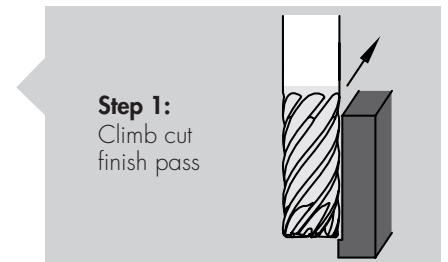

Technical Resources

ADJUSTMENTS FOR BALL NOSE END MILLS

The speeds and feeds of ball nose end mills must be adjusted to ensure proper tool life. Adjustments are based on the amount of tool engagement.

If the depth of cut (ADOC) is <50% of the tool diameter:

Adjustments must be made to determine the effective cutting diameter and to adjust for axial chip thinning. Follow these steps:

STEP 1: Use speed and feed values for slot cuts from the speed and feed charts for the appropriate material and tool diameter.

Note: Make an additional adjustment using the chart to the right if the tool projection exceeds 2.5 x the tool diameter.

Projection	Speed Adj	Feed Adj
> 2.5 to 3 x D	SFM or MMPM x .95	IPT or MMPT x .95
> 3 to 4 x D	SFM or MMPM x .90	IPT or MMPT x .90
> 4 to 5 x D	SFM or MMPM x .80	IPT or MMPT x .80
> 5 to 6 x D	SFM or MMPM x .70	IPT or MMPT x .70

STEP 2: Determine the effective cutting diameter (De) of the end mill based on the axial depth of cut. The effective cutting diameter will be used to make both speed and feed adjustments.

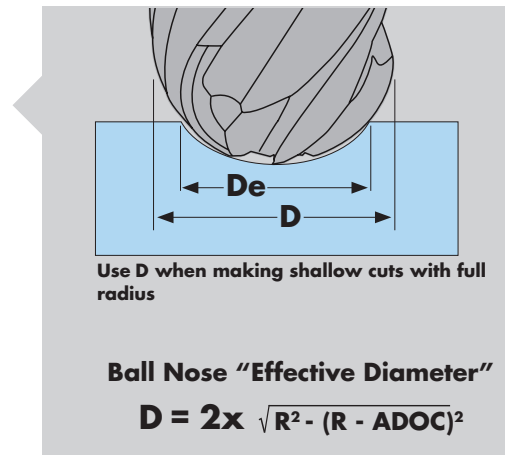

For easy reference, use the charts below.

Fractional:

Depth of Cut (ADOC)	1/8		1/4		3/8		1/2		3/4		1	
	Depth	De	Depth	De	Depth	De	Depth	De	Depth	De	Depth	De
10% of tool diameter	.013	.075	.025	.150	.038	.225	.050	.300	.075	.450	.100	.600
20% of tool diameter	.025	.100	.050	.200	.075	.300	.100	.400	.150	.600	.200	.800
30% of tool diameter	.038	.115	.075	.229	.113	.344	.150	.458	.225	.687	.300	.917
40% of tool diameter	.050	.123	.100	.245	.150	.367	.200	.490	.300	.73	.400	.980
50% of tool diameter	.063	.125	.125	.250	.186	.375	.250	.500	.375	.7500	.500	1.000

Metric:

Depth of Cut (ADOC)	3.0		6.0		10.0		12.0		20.0		25.0	
	Depth	De	Depth	De	Depth	De	Depth	De	Depth	De	Depth	De
10% of tool diameter	.300	1.800	.600	3.600	1.000	6.000	1.200	7.200	2.000	12.000	2.500	15.000
20% of tool diameter	.600	2.400	1.200	4.800	2.000	8.000	2.400	9.600	4.000	16.000	5.000	20.000
30% of tool diameter	.900	2.750	1.800	5.500	3.000	9.165	3.600	10.998	6.000	18.330	7.500	22.913
40% of tool diameter	1.200	2.940	2.400	5.880	4.000	9.800	4.800	11.760	8.000	19.600	10.000	24.500
50% of tool diameter	1.500	3.000	3.000	6.000	5.000	10.000	6.000	12.000	10.000	20.000	12.500	25.000

STEP 3: Calculate speed based on using the effective cutting diameter. Use the standard SFM or M/min to RPM conversion formula. Substitute the effective cutting diameter (De) for the actual tool diameter (D).

STEP 4: Calculate the adjusted feed rate based on the effective cutting diameter and the axial chip thinning formula.

Fractional: $RPM = (SFM \times 3.82) / De$
Metric: $RPM = (M/min \times 318.3) / De$

D = Actual tool diameter
 IPT = Feed rate from chart for slot milling
 De = Effective cutting diameter
 MMPT = Feed rate from chart for slot milling

Fractional: $IPTadj = (D \times IPT) / De$
Metric: $MMPTadj = (D \times MMPT) / De$

The new feed rate is calculated:

Fractional: $IPM = RPM \times (Z \times IPTadj)$
Metric: $MMPM = RPM \times (Z \times MMPTadj)$

IPM = Inches per minute
 Z = # of flutes
 IPT adj = Adjusted chip load per tooth fractional
 MMPTadj = Adjusted chip load per tooth metric
 MMPM = Millimeters per minute

If the axial depth of cut (ADOC) is ≥50% of the tool diameter:

- Use the speed and feed values shown for the slotting operation in the speed and feed charts for the series of end mill being used.
- If the tool projection exceeds 2.5 x the tool diameter, adjust the slotting speeds and feeds by the chart for long reach tool adjustments. This can be found on page 139.

SURFACE FINISH

Radial depth of cut (RDOC), or step-over, is based on the desired finish. The lighter the step-over, the lower the scallop height (material left uncut by the radius of the tool), and the better the finish. These charts calculate approximate scallop height using the following formula:

$h \sim (ae^2) / (8R)$

h = Scallop height
 ae = Radial step-over
 R = Radius of end mill
 (tool diameter x .5)

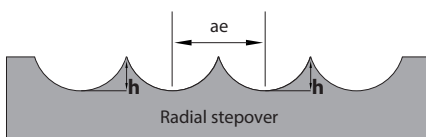

Fractional				Metric			
Tool Diameter	Step-over % of OD	Step-over Actual	Approx Scallop Height	Tool Diameter	Step-over % of OD	Step-over Actual	Approx Scallop Height
1/8	10%	.013	.0003	3.0 mm	10%	.300	.0075
	20%	.025	.0013		20%	.600	.0300
	30%	.038	.0028		30%	.900	.0675
1/4	10%	.025	.0006	6.0 mm	10%	.600	.0150
	20%	.050	.0025		20%	1.200	.0600
	30%	.075	.0056		30%	1.800	.1350
3/8	10%	.038	.0009	10.0 mm	10%	1.000	.0250
	20%	.075	.0038		20%	2.000	.1000
	30%	.113	.0084		30%	3.000	.2250
1/2	10%	.050	.0013	12.0 mm	10%	1.200	.0300
	20%	.100	.0050		20%	2.400	.1200
	30%	.150	.0113		30%	3.600	.2700
3/4	10%	.075	.0019	20.0 mm	10%	2.000	.0500
	20%	.150	.0075		20%	4.000	.2000
	30%	.225	.0169		30%	6.000	.4500
1	10%	.100	.0025	25.0 mm	10%	2.500	.0625
	20%	.200	.0100		20%	5.000	.2500
	30%	.300	.0225		30%	7.500	.5625

Technical Resources

Tool Holder Recommendations When Using HEM

HEM tool paths reduce the amount of radial cutting forces exerted on the end mill, allowing more aggressive speeds and feeds and higher metal removal rates (MRR). Along with higher MRRs come higher axial cutting forces, which work to pull the end mill out of the holder and into the part. Using a holder with gripping power high enough to overcome these increased axial forces is critical for successful machining in HEM tool paths. For better tool life, it is also important to choose a holder that minimizes the run-out of the tool assembly.

Holder Type	Use in HEM Programming?
Press fit	Recommended
Shrink fit	Recommended
Mechanical chuck	Recommended
Hydraulic chuck	Only if ADOC < 3 x D
Advanced ER collet	Only if ADOC < 3 x D
Standard ER collet	Not recommended
Side lock holder	MUST keep run-out minimized

Determining Power Requirements

It can be helpful to understand the power requirements for an application. The following formulas calculate spindle and motor horsepower and spindle torque.

Step 1: Metal Removal Rate (MRR) =
(Tool Feed Rate) x Radial DOC x Axial DOC

Step 2: Spindle HP = Metal Removal Rate x UHP

Step 3: Motor HP = Spindle HP / Efficiency

Step 4: Spindle Torque (ft. lbs.) =
(Spindle HP x 63,030) / RPM

UHP Factors Ratings

Material	Factor
Aluminum	0.3
Cast iron	0.8
Carbon steel	1
Alloy steel	1.1
Mold steel	1.2
Tool steel	1.2
Stainless steel	1.5
Titanium	1.8
Hi-temp alloys	2

Efficiency Ratings

Spindle Type	%
Direct drive	90%
Gear drive	85%
2 Belt	70%
1 Belt	50%
Average	80%

Chip Thinning & Light Cuts

When using a light radial stepover, the chip that is created is thinner than what is entered into the program. This thinning occurs when the radial stepover is less than 50% of the tool diameter.

When the chips are too thin, the cutting edges tend to “rub” the part and begin to wear too quickly. To avoid this problem, use the radial chip-thinning formula at right to calculate an adjusted feed per tooth necessary to maintain optimal chip thickness.

Radial Chip Thinning Adjustment
$$IPT_{adj} = \frac{IPT \times (D/2)}{\sqrt{(D \times RDOC) - RDOC^2}}$$

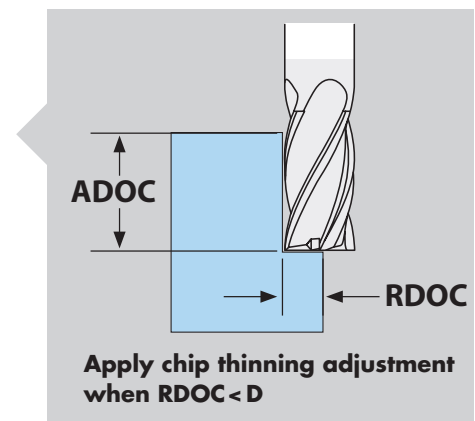

*This adjustment has been applied in the Speed and Feed charts in this catalog.

Adding a Weldon Flat

IMCO uses the location and dimensions specified in the ANSI B94.19-1985 standard when adding a Weldon flat to an end mill. All requests for locations and dimensions not matching the ANSI standard must be communicated in writing to IMCO.

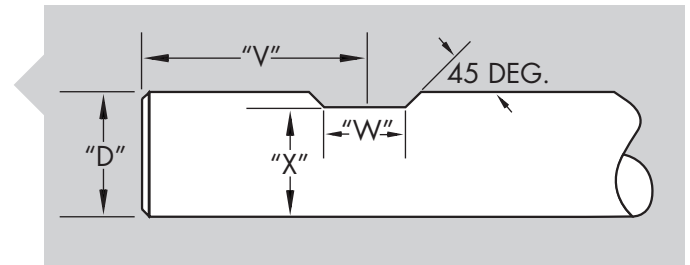

Fractional

"D"	"W"	"X"	"V"
Shank Diameter	+0.015 -0	+0 -0.010	+0.015 -0.015
.375	.281	.325	.781
.5	.330	.440	.890
.625	.406	.560	.953
.75	.455	.675	1.016
1	.516	.925	1.140
1.25	.516	1.156	1.140

Metric

"D"	"W"	"X"	"V"
Shank Diameter	+0.015 -0	+0 -0.010	+0.015 -0.015
10 mm (.3937)	.276	.335	.787
12 mm (.4724)	.315	.409	.886
16 mm (.6299)	.394	.559	.945
20 mm (.7874)	.433	.716	.984
25 mm (.9843)	.472	.905	1.260
1.25	.516	1.156	1.140

Note: All dimensions are shown in fractional decimal equivalents.

Conversions for Fractional and Metric Units

Multiply	By	To Get
Millimeters	0.03937	Inches
Centimeters	0.3937	Inches
Meters	3.2808	Feet
Millimeters Per Minute (MM/min)	0.03937	Inches Per Minute (IPM)
Cubic Centimeters Per Minute (cm ³)	0.061	Cubic Inches Per Minute (in ³)
Meters Per Minute (M/min)	3.2808	Surface Feet Per Minute (SFM)
Inches	25.4	Millimeters
Inches	2.54	Centimeters
Feet	0.3048	Meters
Inches Per Minute (IPM)	25.4	Millimeters Per Minute (MM/min)
Cubic Inches Per Minute (in ³)	16.387	Cubic Centimeters Per Minute (cm ³)
Surface Feet Per Minute (SFM)	0.3048	Meters Per Minute (M/min)

TECHNICAL RESOURCES



Toolbot

Check it before you wreck it.

The brand new, easy to use online tool for dynamic speeds and feed from IMCO.

Simply input your part number or describe your tool, input select details about your application, confirm your machine details, and get ready to rock and roll with highly technical and in-depth speed and feed recommendations.

It's as easy as 1, 2, 3, 4!

1 Your End Mill

Provide the part number for your IMCO end mill, or describe your part.

Part Number

Q Enter part number

Alternatives: Don't know the number? Use our Tool Filter to find your part.

2 Choose a Material

Select your material group. You may filter by ISO or select a specific material.

ISO Filter

H K M P S

Material Group *

Material

optional

3 Operation Details

Select your operation and add details about the feature.

Operation *

Feature Depth * in

Options based on IMCO recommendations for your material and your part's model and specifications.

4 Machine Limits

Provide the capability of your machine so we can calculate accurate recommendations.

Max Spindle Power *

250 hp

Max Feed Rate *

3000 ipm

Max RPM *

75000 rpm

Decimal Equivalent Chart

Tool Size	Decimal Equiv.	Tool Size	Decimal Equiv.	Tool Size	Decimal Equiv.	Tool Size	Decimal Equiv.	Tool Size	Decimal Equiv.	Tool Size	Decimal Equiv.
#80	.0135	1/16	.0625	3.30	.1299	5.40	.2126	O	.3160	17/32	.5312
0.35	.0138	1.60	.0630	3.40	.1339	#3	.2130	8.10	.3189	13.50	.5315
#79	.0145	#52	.0635	#29	.1360	5.50	.2165	8.20	.3228	35/64	.5469
1/64	.0156	1.65	.0650	3.50	.1378	7/32	.2188	P	.3230	14.00	.5512
0.40	.0158	1.70	.0669	#28	.1405	5.60	.2205	8.25	.3248	9/16	.5625
#78	.0160	#51	.0670	9/64	.1406	#2	.2210	8.30	.3268	14.50	.5709
0.45	.0177	1.75	.0689	3.60	.1417	5.70	.2244	21/64	.3281	37/64	.5781
#77	.0180	#50	.0700	#27	.1440	5.75	.2264	8.40	.3307	15.00	.5906
0.50	.0197	1.80	.0709	3.70	.1457	#1	.2280	Q	.3320	19/32	.5938
#76	.0200	1.85	.0728	#26	.1470	5.80	.2283	8.50	.3346	39/64	.6094
#75	.0210	#49	.0730	3.75	.1476	5.90	.2323	8.60	.3386	15.50	.6102
0.55	.0217	1.90	.0748	#25	.1495	A	.2340	R	.3390	5/8	.6250
#74	.0225	#48	.0760	3.80	.1496	15/64	.2344	8.70	.3425	16.00	.6299
0.60	.0236	1.95	.0768	#24	.1520	6.00	.2362	11/32	.3438	41/64	.6406
#73	.0240	5/64	.0781	3.90	.1535	B	.2380	8.75	.3445	16.50	.6496
#72	.0250	#47	.0785	#23	.1540	6.10	.2402	8.80	.3465	21/32	.6562
0.65	.0256	2.00	.0787	5/32	.1562	C	.2420	S	.3480	17.00	.6693
#71	.0260	2.05	.0807	#22	.1570	6.20	.2441	8.90	.3504	43/64	.6719
0.70	.0276	#46	.0810	4.00	.1575	D	.2460	9.00	.3543	11/16	.6875
#70	.0280	#45	.0820	#21	.1590	6.25	.2461	T	.3580	17.50	.6890
#69	.0292	2.10	.0827	#20	.1610	6.30	.2480	9.10	.3583	45/64	.7031
0.75	.0295	2.15	.0846	4.10	.1614	1/4	.2500	23/64	.3594	18.00	.7087
#68	.0310	#44	.0860	4.20	.1654	E	.2500	9.20	.3622	23/32	.7188
1/32	.0312	2.20	.0866	#19	.1660	6.40	.2520	9.25	.3642	18.50	.7283
0.80	.0315	2.25	.0886	4.25	.1673	6.50	.2559	9.30	.3661	47/64	.7344
#67	.0320	#43	.0890	4.30	.1693	F	.2570	U	.3680	19.00	.7480
#66	.0330	2.30	.0906	#18	.1695	6.60	.2598	9.40	.3701	3/4	.7500
0.85	.0335	2.35	.0925	11/64	.1719	G	.2610	9.50	.3740	49/64	.7656
#65	.0350	#42	.0935	#17	.1730	6.70	.2638	3/8	.3750	19.50	.7677
0.90	.0354	3/32	.0938	4.40	.1732	17/64	.2656	V	.3770	25/32	.7812
#64	.0360	2.40	.0945	#16	.1770	6.75	.2657	9.60	.3780	20.00	.7874
#63	.0370	#41	.0960	4.50	.1772	H	.2660	9.70	.3819	51/64	.7969
0.95	.0374	2.45	.0965	#15	.1800	6.80	.2677	9.75	.3839	20.50	.8071
#62	.0380	#40	.0980	4.60	.1811	6.90	.2717	9.80	.3858	13/16	.8125
#61	.0390	2.50	.0984	#14	.1820	I	.2720	W	.3860	21.00	.8268
1.00	.0394	#39	.0995	#13	.1850	7.00	.2756	9.90	.3898	53/64	.8281
#60	.0400	#38	.1015	4.70	.1850	J	.2770	25/64	.3906	27/32	.8438
#59	.0410	2.60	.1024	4.75	.1870	7.10	.2795	10.00	.3937	21.50	.8465
1.05	.0413	#37	.1040	3/16	.1875	K	.2810	X	.3970	55/64	.8594
#58	.0420	2.70	.1063	4.80	.1890	9/32	.2812	Y	.4040	22.00	.8661
#57	.0430	#36	.1065	#12	.1890	7.20	.2835	13/32	.4062	7/8	.8750
1.10	.0433	2.75	.1083	#11	.1910	7.25	.2854	Z	.4130	22.50	.8858
1.15	.0453	7/64	.1094	4.90	.1929	7.30	.2874	10.50	.4134	57/64	.8906
#56	.0465	#35	.1100	#10	.1935	L	.2900	27/64	.4219	23.00	.9055
3/64	.0469	2.80	.1102	#9	.1960	7.40	.2913	11.00	.4331	29/32	.9062
1.20	.0472	#34	.1110	5.00	.1969	M	.2950	7/16	.4375	59/64	.9219
1.25	.0492	#33	.1130	#8	.1990	7.50	.2953	11.50	.4528	23.50	.9252
1.30	.0512	2.90	.1142	5.10	.2008	19/64	.2969	29/64	.4531	15/16	.9375
#55	.0520	#32	.1160	#7	.2010	7.60	.2992	15/32	.4688	24.00	.9449
1.35	.0531	3.00	.1181	13/64	.2031	N	.3020	12.00	.4724	61/64	.9531
#54	.0550	#31	.1200	#6	.2040	7.70	.3031	31/64	.4844	24.50	.9646
1.40	.0551	3.10	.1220	5.20	.2047	7.75	.3051	12.50	.4921	31/32	.9688
1.45	.0571	1/8	.1250	#5	.2055	7.80	.3071	1/2	.5000	25.00	.9843
1.50	.0591	3.20	.1260	5.25	.2067	7.90	.3110	13.00	.5118	63/64	.9844
#53	.0595	3.25	.1280	5.30	.2087	5/16	.3125	33/64	.5156	1	1.000
1.55	.0610	#30	.1285	#4	.2090	8.00	.3150				

EZ-QUOTE GUIDE

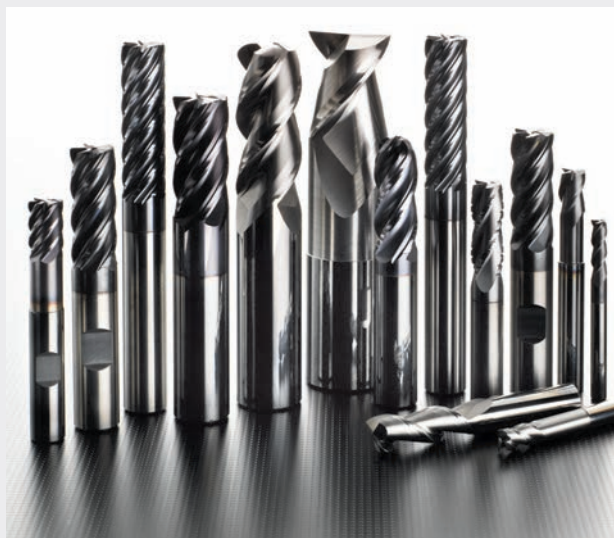

IMCO's smart coding system simplifies the way to communicate all of the features needed for a made-to-order tool. Just use the specifics of the tool you need quoted, "plug" them into the coding system, and you're there!

Each EZ-Quote part number describes the tool itself. It starts with general information (type of tool and tool family) and gets more specific as you go.

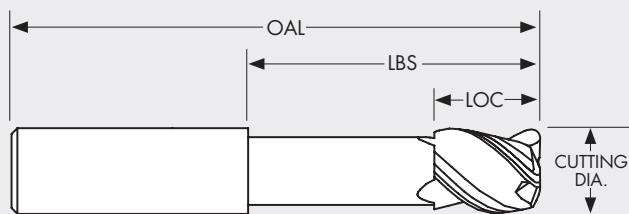

Building the EZ-Quote code, step by step.

Insert the numbers in the segments as indicated here. If a certain segment doesn't apply (neck dimension, taper or special shank), just skip it. Separate the segments with hyphens.

- 1** Enter the **model number**.
For example, the model number for a 5-Flute enDURO end mill would be M525.
- 2** Enter the **tool diameter** (always to three decimal places). Include the leading zero for diameters less than 1 in. or 10mm.
- 3** Enter the **length of cut (LOC)**. Include the leading zero for an LOC less than 1 in. or 10mm.
- 4** Enter the **length below shank (LBS) or reach**. Include the leading zero for an LBS less than 1 in. or 100mm. Indicate that this is a neck dimension by placing an N before the number. (If the tool has no neck, you can skip this segment altogether.)
- 5** Enter the **end/corner** type or size. Include the leading zero for corner radii less than 1 in. or 1 mm. For any other end/corner type, just indicate the type: SQ = square end, BN = ball nose, CC = corner chamfer.
- 6** If the **overall length** you need is not the standard length for the combination of tool diameter, LOC and LBS, then enter the overall length (**OAL**) here. Indicate that this is an overall length by placing an L before the number. If you do not specify an overall length, we will assume it is standard length.
- 7** Enter the code for the **type of shank** you need (W = Weldon flat, WN = whistle notch, P = plain). If you do not specify a shank style, we will assume it is a plain shank.
- 8** Enter the coating **ONLY** if it is different than the standard coating for that model.

	1	2	3	4	5	6	7	8
	MODEL	TOOL DIAMETER	LENGTH OF CUT (LOC)	LENGTH BELOW SHANK (LBS)	END	OVERALL LENGTH	SHANK	COATING
INCH	M525	0375	0750	N2375	045	L4	W	AlCrNX
METRIC	E14	060	008	N020	050	L075	P	NONE

Segments highlighted in white may be omitted.

The metalmorphosis begins with IMCO.



We design great end mills, and then we make them even better. We solve machining issues and then take those solutions to the next level. We always ask, "What if ... ?" That way of thinking is what puts IMCO at the frontier of advanced end mill design.

So, ask yourself: What if IMCO could solve the machining issues holding us back?

Call us and find out.

In USA call **1-800-765-4626**

International **419-661-6313**

Fax **419-661-6314**

Email **support@imcousa.com**



Visit **www.imcousa.com**
by scanning this code with a
QR code reader.



Power. Precision. Performance.

IMCO Carbide Tool Inc.

28170 Cedar Park Blvd., Perrysburg, OH 43551

©2021 IMCO Carbide Tool Inc.
Made in U.S.A.